

INVESTIGATION THE MACHINING OF THE ENGINEERING POLYMERS

¹Róbert Kovács, ¹Péter Korzenszky, ¹Róbert Keresztes

¹Hungarian University of Agriculture and Life Sciences, Páter K. 1, 2100, Gödöllő, Hungary
e-mail: kov.robert93@gmail.com

Received: 16th June

Accepted: 11th September

ABSTRACT

During the turning process, we have investigated the problems that can arise, such as avoiding the formation of flow chips, which are eliminated by sawing the workpiece longitudinally. Furthermore, we measured the main cutting forces acting on the blade and the cutting forces in the feed direction at different feed rates, depths of grip and cutting speeds, and investigated possible correlations between these.

Chips produced at different cutting parameters and with different materials were investigated. All turning operations are carried out without emulsion and all other coolants for environmental and other reasons.

The specific cutting resistances have been determined, which are essential for determining good tool utilisation and also for planning the economics of machining

The aim of this research is to define machining parameters that can be used in practice for the engineering plastics under investigation, so that the machining of these materials by turning can be made more economical.

Keywords: Turning, cutting, polymers,

1. INTRODUCTION

During the turning process, we examined the problems that arise, such as avoiding the formation of flowing chips, which is eliminated by sawing the workpiece in the longitudinal direction. We also measured the main cutting force acting on the tool and the cutting force in the feed direction, at different feeds, depths of cut and different cutting speeds, among which we examined the possible correlations. The chips produced with different cutting parameters and different materials were examined. Due to environmental protection and other considerations, all turning is carried out without emulsion or any other cooling-lubricating fluid. We determined the specific cutting resistances, which are important for determining the good utilization of the tool and can also be used for planning the economy of machining. The aim of the research is to define the cutting parameters that can be used well in practice for the examined technical plastics, with which turning the given materials can become more economical. [10], [8]

2. MATERIALS AND METHODS

For my measurements, I chose the most commonly used polymers in technical practice. The three different polymers are:

- Polyamide 6 (PA6)
- Ultra High Molecular Weight Polyethylene (UHMW PE HD1000)
- Polyoxymethylene copolymer (POM C)

2.1. The turning process

Turning is one of the most common cutting operations in industry, it is used in both individual production and mass production mainly in automated form. Turning is cutting performed with a single-edged tool, with the continuous removal of a chip with a constant cross-section. [3], [10]

Forces occurring during turning

During turning, three-directional forces act on the tool. The main cutting force (F_c) acts perpendicularly to the blade, the cutting force (F_m) acts parallel to the tool blade, and the forward force (F_t) acts perpendicular to the blade in a horizontal direction. The main cutting force is the largest of these.[6]

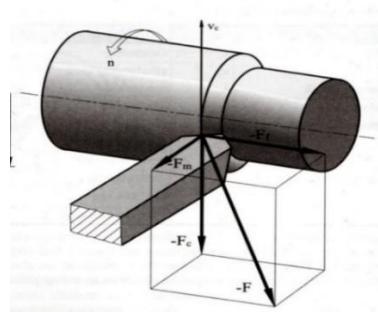

Figure1: Force relations of turning [2]

2.2. The measuring system:

The cutting force and the feed force were measured using a lathe tool shank equipped with strain gauges. The signal from the stamps is sent to a Spider 8 type electrical measuring system, which is connected to the computer via a parallel port.



Figure 2: The turning tool with strain gauge[9]

The data is collected using the Catman software, which collects the data and also graphically represents the occurring forces as a function of time. After saving, the measurement results can be opened with a spreadsheet program.[4]

Lathe insert used:

CCGX 09 T3 04 AL H10

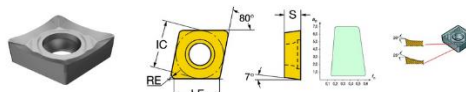

Figure 3 – The geometry of the insert [11]

2.3. Parameters used during the measurements:

During the tests, the cutting speed was 500, 300, and 100 m/min, with each speed the value of the feed rate per revolution was 0.05; 0.1; 0.2; 0.4; It was 0.5mm/revolution. The depth of cut values for all set cutting speeds and feed rates are 0.1; 0.2; 0.5; 1; It was 2 and 5 mm, respectively. Within the table, each framed part indicates the parameters included in a program. It can be seen from this that in a cutting program the cutting speed and depth of cut were constant and the feed rate was changed. The feed was changed after a 10mm longitudinal movement of the tool, and this is how the 50mm long machined surface came out in all programs.

3. RESULTS AND DISCUSSION

After performing test measurements, I started the measurements with the PA 6, with a cutting speed of 500 m/min.

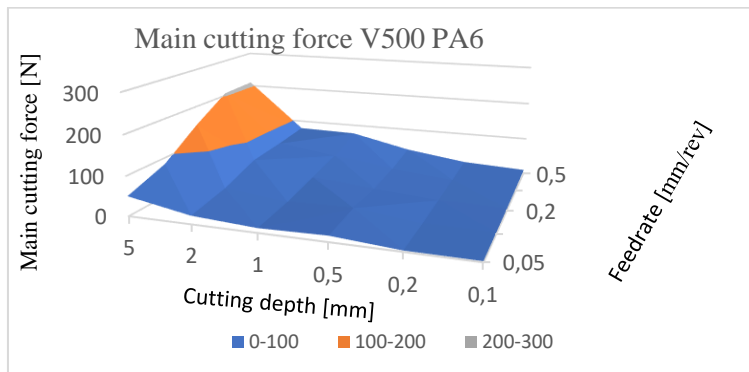

Figure 4 – The main cutting force PA6

The diagram clearly shows the values of the main cutting force as a function of feed and depth of cut. During the measurement, it can be noted that at the highest cutting parameters indicated in the diagram, a strong sound effect accompanied the turning, which was probably caused by vibrations.

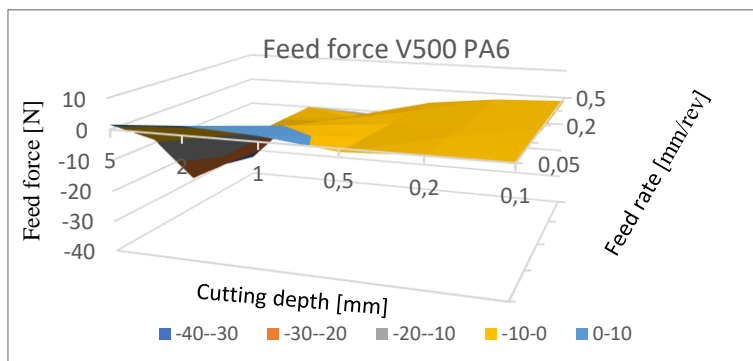

Figure 5 – Feed force PA6

It is clear that the forward force takes on mostly negative values, which shows that the lathe tool should not be pushed but pulled, i.e. held back, because the workpiece pulls the tool on itself, so to speak. The feed

force becomes negative only above a certain feed value, which is shown as an example in the diagram below with a cutting speed of 500 m/min and a depth of cut of 5 mm.

During the measurements performed at cutting speeds of 300 and 100 m/min, the nature of the thrust force showed similar results. As the cutting speed was reduced, the feed force also showed a decreasing trend.

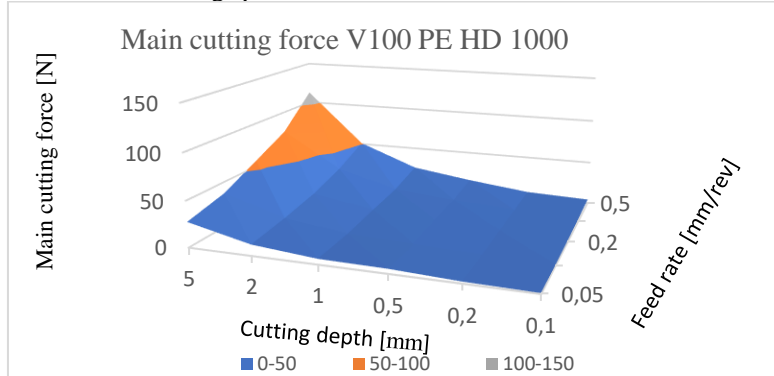

Figure 6 – Main cutting force PE HD 1000

Even at this cutting speed, it can be said about the main cutting force that it varies relatively evenly, and no jumps are observed anywhere.

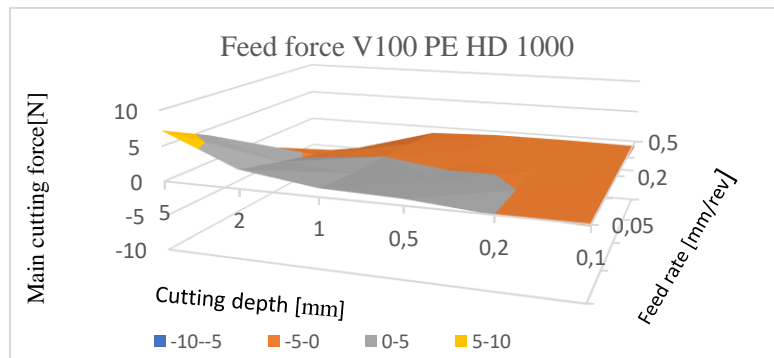

Figure 7 – Feed force PE HD 1000

The feed force behaved similarly at this cutting speed as at the previous ones, with the difference that in the case of a small feed, the feed force took on higher positive forces.

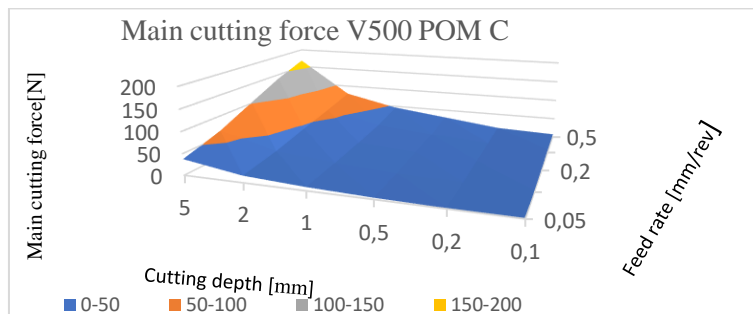

Figure 8 – Main cutting force POM C

It can be observed that the main cutting force changes evenly depending on the feed and depth of cut. It doesn't show major outliers anywhere. At 300 and 100m/min cutting speeds, the main cutting force showed similar values.

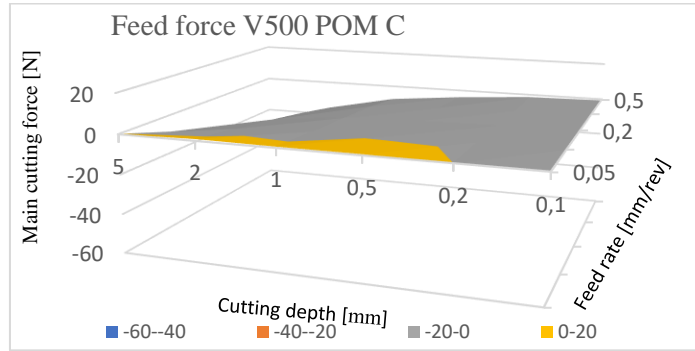

Figure 9- Feed force POM C

Smaller positive forces appeared in the propulsive force than in the case of the previously examined polymers.

3.1. Specific cutting resistance:

The specific cutting resistance shows how much force is required to separate 1mm² of material. It can be clearly seen that it shows higher values in the case of small feed and small depth of cut than at higher values of the same parameters.

$$k_s = \frac{F_f}{f \cdot a} \left[\frac{N}{\text{mm}^2} \right] \quad (1)$$

F_f – main cutting force [N]

f – feed rate [mm/rev]

a – cutting depth [mm]

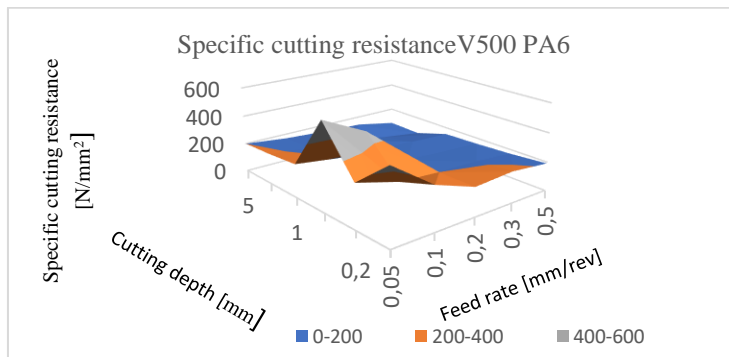

Figure 10 – Specific cutting resistance PA6

In the case of PA, the change is not completely uniform, but nevertheless it is clear that the value of the specific cutting resistance decreases along with the increase of the depth of cut and the feed and almost does not change after a certain value.

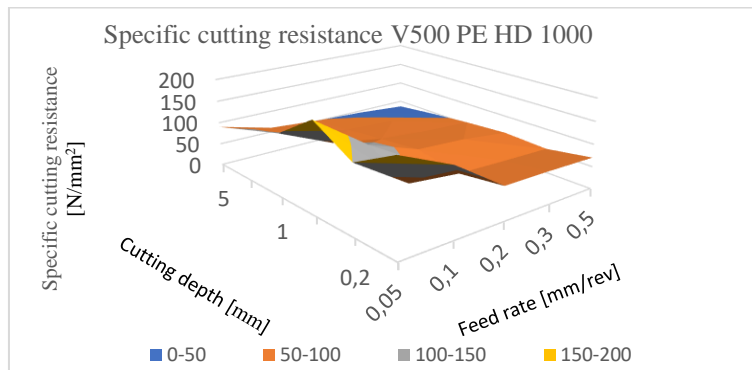

Figure 11 - Specific cutting resistance PE HD1000

In the case of PE HD 1000, the value of the specific cutting resistances is already lower, but the ratio shows much different values in the diagram for the different cutting depth and feed settings. It can also be observed here that the value of the specific cutting resistance is almost constant in a certain area.

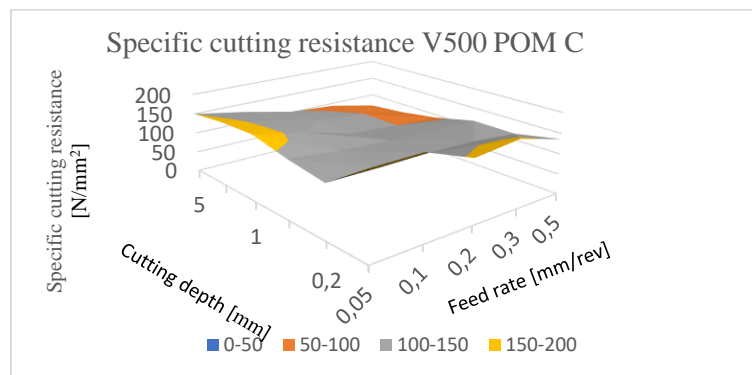

Figure 12 - Specific cutting resistance POM C

In the case of POM C, the values of the specific cutting resistances are located between the values established for PA6 and PE HD 1000 examined previously. The previously observed area of almost constant values does not exist here, but here the values move within narrower limits in the entire examined range.

3.2. The ratio of the specific cutting resistance and the tensile strength

During my tests, I tried to look for some kind of correlation between the strength and the forces that occur during cutting, based on which the magnitude of the main cutting force that occurs can be estimated in advance.

The applied relation:

$$\frac{k_s}{\sigma_B} [-] \tag{2}$$

k_s – specific cutting resistance [$\frac{N}{mm^2}$]

σ_B – tensile strength of the polymer [$\frac{N}{mm^2}$]

The result is a dimensionless ratio, the change of which is presented below.

PA6

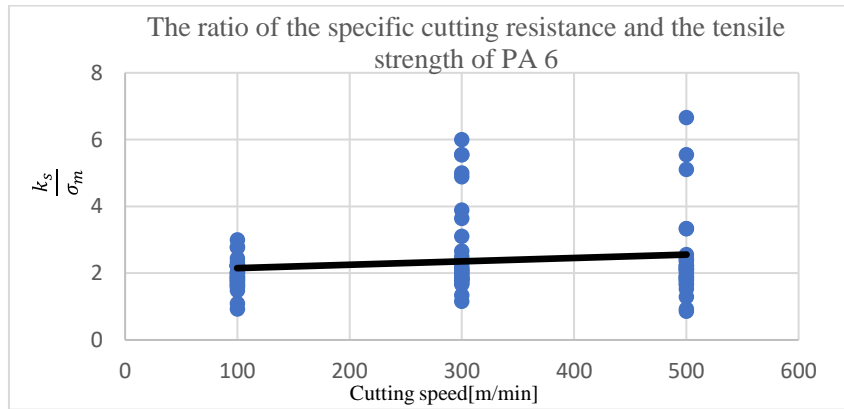

Figure 13 - The ratio of the specific cutting resistance and the tensile strength of PE HD 1000

The diagram clearly shows that the ratios are mainly around the 2 value. The straight line shows the change in their average by changing the cutting speed.

PE HD 1000

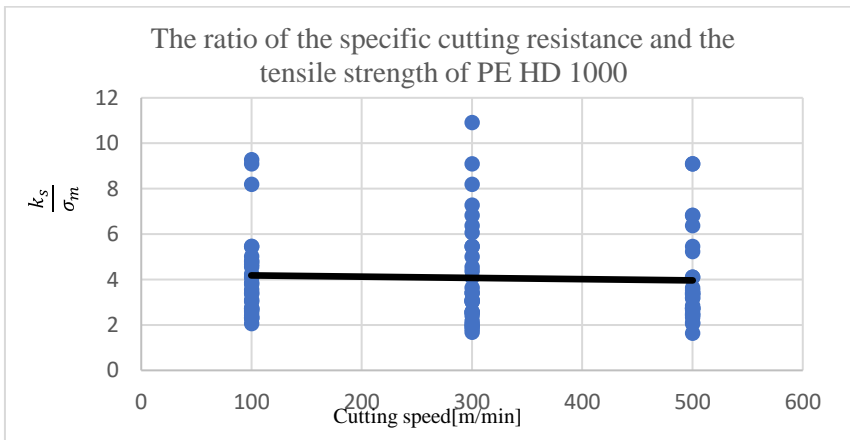

Figure 14 - The ratio of the specific cutting resistance and the tensile strength of PE HD 1000

The opposite phenomenon is observed for PE HD 1000 compared to PA6. The ratio I have set decreases on average with increasing cutting force. Here the ratio is around 4.

POM C

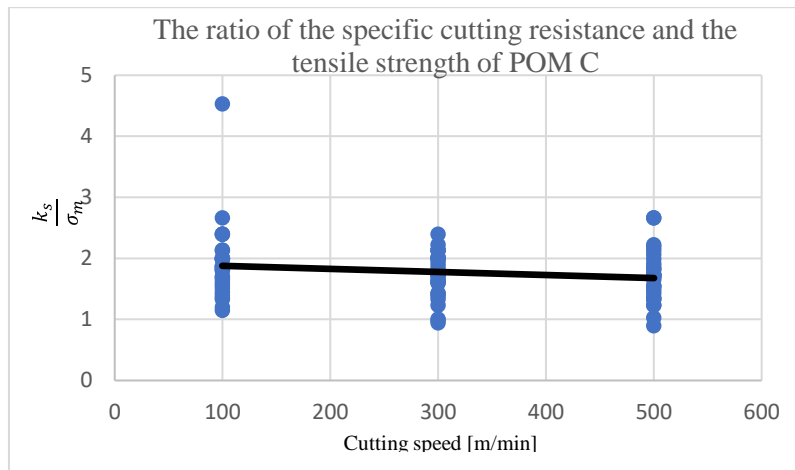

Figure 15 - The ratio of the specific cutting resistance and the tensile strength of POM C

In the case of POMC, the ratio changes similarly to PE HD 1000. It is also clear that the values show a similar distribution. The average value of the ratio is between 1.5 and 2.

4. CONCLUSIONS

It is clear that different polymers behave differently during turning, and that different forces occur with the same cutting parameters for different materials. In the case of PA6, with both inserts, the formation of chip types was also observed, which showed a favorable picture in the upper range of the cutting parameters I examined, because even if elementary chips were not achieved, transitional chips were produced in these ranges. The main cutting and feed forces, as well as the evolution of the specific cutting resistances, were shown on diagrams. In the case of PE HD 1000, the main cutting force and the feed force were significantly lower. Practically, even during the test, flowing chips were produced in all cases. POM C is the best machinable material among the examined polymers. During the test with the upper cutting parameters, elementary chips were already formed, and moving downwards with the setting values, a temporary, then easily broken, flowing chip was formed. Regarding the specific cutting resistances shown in the diagrams, it can be said as a whole that it showed high values in the case of small rotation depths and small feeds, while the opposite was observed in the case of high feed and high cutting depth values, i.e. low cutting resistances were shown. Of these, the latter is more favorable from an economic point of view. First, I look at the case of POM C, since the specified specific cutting resistance and tensile strength ratios can be used in practice to estimate the occurring specific cutting resistance based on the tensile strength, and from this the magnitude of the expected main cutting force can be determined for a given cutting depth and feed. From a practical point of view, this can be extremely beneficial for quick calculations, tool selection and many more aspects. In the case of PA 6, the ratio already showed a larger deviation, and here the value increased with the increase of the cutting speed. Despite the larger standard deviation, it can also be used to estimate the specific cutting resistance that occurs, but it must be taken into account that the result is more uncertain. In the case of PE HD 1000, the ratio showed a similar standard deviation as in the case of PA 6. However, as the cutting force

increases, the value of this ratio decreases. Despite the mentioned larger standard deviation, it can also be used to estimate the cutting data, although similarly to the case of PA 6, to a more imprecise degree. Which is less important with this material, as smaller forces occur when cutting it. The results of the tests can be beneficially applied in practice even immediately, taking them into account the economy of processing can be increased and since the measurements were carried out without emulsion or any other cooling, last but not least, the production can be made more environmentally friendly, in addition to which the processing can also be more economical, because if cooling lubricant is not required, then there is no need to take care of its handling or transportation. The ratios of the determined specific cutting force and the tensile strength of the material can be advantageously used and produce fast, well-approximated results, which is an important aspect in practice.

ACKNOWLEDGMENT

The research was supported by the project 'The feasibility of the circular economy during national defense activities' of 2021 Thematic Excellence Program of the National Research, Development and Innovation Office under grant no.: TKP2021-NVA-22, led by the Centre for Circular Economy Analysis.

REFERENCES

- [1] Kalácska G., Kozma M., Zsidai L., Keresztes R. (2007): Műszaki polimerek és kompozitok a gépészmérnöki gyakorlatban, 3C-Grafika Kft., Gödöllő, ISBN 978-963-06-1566-2, p. 315
- [2] Fenyvessy T., Fuchs R., Plósz A. (2010): Műszaki Táblázatok, NSZFI, Budapest, ISBN 978-963-746-973-2,
- [3] Kári-Horváth A., Fledrich G., Kakuk Gy., Zsidai L. (2016): Gépgyártástechnológia, Szent István Egyetemi Kiadó Nonprofit Kft., Gödöllő
- [4] Sarankó Á., Zsidai L., Keresztes R., Schrempf N. (2019): Force measuring methods of milling and turning for experimental use – A brief review, Mechanical Engineering Letters: research and development 19 pp. 208-218. , 11 p., ISSN 2060-3789
- [5] Sarankó Á., Kalácska G., Keresztes R. (2019): Analysis of Vibration During Turning Process of Different Materials, International Journal of Engineering and Management Sciences (IJEMS) Vol. 4. No. 1, pp. 200-205.
- [6] Keresztes R., Fledrich G., Kalácska G. (2010): Polimerek esztergálásánál fellépő forgácsolóerő vizsgálata, MŰANYAG ÉS GUMI 47 : 3 pp. 106-110. , 5 p.
- [7] Kalácska G. (2005): Műszaki műanyag féltermékek forgácsolása, Quattroplast Kft., Gödöllő
- [8] Kalácska G., Keresztes R., Kozma M., Zsidai L., Kalácska G. (szerk.) (2017): Műszaki polimerekről gépészmérnököknek: alapismeret, technológia, tudomány, Gödöllő, Magyarország: Quattroplast Kft., 324 p., ISBN: 9789631276923
- [9] Kovács R., Korzenszky P., Keresztes R. (2021): Research on the Turning of Technical Polymers, SCIENTIFIC BULLETIN SERIES C: FASCICLE MECHANICS, TRIBOLOGY, MACHINE MANUFACTURING TECHNOLOGY 35 pp. 49-53. , 5 p.
- [10] www.dieterle-tools.de
- [11] www.sandvik.coromant.hu
- [12] www.quattroplast.hu