

STATE EVALUATION MODEL FOR WATER AS AN ENVIRONMENTAL ELEMENT

KONCSOS LÁSZLÓ

Budapest University of Technology and Economics, Dept. of Sanitary and Environmental Engineering
H-1111 Budapest, Műegyetem rkp. 3. UV building, Hungary, e-mail: koncsos@vkkt.bme.hu.

Introduction

The Streeter-Phelps model invented in 1925 was the first attempt at describing humans' environmental pollution on a mathematical basis, with relatively simple tools in a local extent. The accelerating development of sciences and computer technology have produced new needs; and, thanks to the steady growth of computing speed, to the perfection of numerical methods and, not last, to the improvement in our attitudes, by now we are capable of describing a constantly growing circle of environmental pollution problems in their inter-relationships.

The scale of the questions examined is getting wider. From the local description we have got to the continental extent by now – mainly in modelling air pollution –, in case of surface water bodies the typical scale nowadays is related to the size of watersheds.

Since the first methodological developments examining the oxygen content of rivers, it has become possible to describe much more complex phenomena, for instance the mechanics of the nutrient accumulation typical of our rivers and lakes, and the consequent eutrophication, where often the cycling of several dozens of inter-related state variables are being modelled. Nowadays, instead of the empirical approaches of earlier times, the methodical principles of the applied procedures focus on deterministic models describing causal relationships as well as on the introduction of stochastic and combined algorithms – parallel, or as alternatives, to each other. However, describing the recipient and the watershed together and in interaction with each other still represents a problem.

Our aim was to describe the state of the environment by physically founded equations, since this way we can mostly rely on the rapidly spreading remote sensing and satellite detecting databases as well in the parametrisation the models.

The fundamental means of examining environmental quality problems is the transport equation that provides the specific formulation of the law of mass conservation. From the beginnings of mathematical modelling, the examinations have been directed to the necessary and possible simplification of this equation, mainly to the reduction of the number of dimensions, to the elimination of the transient states, and to the separation of the reaction kinetic submodels that are inevitable when describing the advection. A repeated question of this present study was how, after the necessary transformation, the decomposition-aggregation principle (SOMLYÓDY and VAN STRATEN 1986), invented in the 1980's, can be used to solve the above mentioned problem, in a wider group of examined issues.

The aim of water quality, and in general, environmental, modelling is not only to describe and understand phenomena, but it also has to serve as a means to assist

decision-making. The basics of modern engineering attitude is to think in options, or scenarios, the choice amongst which will be made on the basis of risk analysis or multi-criteria decision theory. In relation to the change in attitude, important are the shift from protection towards regulation, to prevention, to solutions that are sustainable on the long-term, and to the taking into account of ecological considerations, whose efficient means is the decision-support system (DSS).

Any decision-support system is fundamentally based on the level of description models, but is not equivalent to it by any means. This way, for instance, (a) it is user-friendly according to the needs of the conceptual planning; (b) it makes possible to include, and produce, options, in accordance with their scale; (c) it ensures that the scenarios are produced and taken into account, within the frames of e.g. the Monte Carlo method; (d) furthermore, it ensures the multilateral evaluation of these. It does all this in a way that the numerous options can be efficiently analysed.

In the transport focused approach both the load and the concentration of the state variables, typical of the state of the recipient, can be considered as the indicators of the system. Paradoxically, the most important features of the indicators are not their actual value, but the degree and the reason of their transformation, which, in this approach, can be analysed in a quantitative sense.

Methodology

The decision-support system that has been developed through the current research extends to describing the surface hydraulic and pollution transport processes as well as the movement and pollution of the close-to-surface groundwater. Accordingly, it is suitable for formulating the boundary conditions of the pollution expansion processes in the deeper geological layers.

The system of models is essentially based on connecting three types of models, which are the following ones:

- (i) Hydrological and hydrodynamical models,
- (ii) Transport model,
- (iii) Water quality model.

The basis of the conditions for feasibility is connecting existing models and data bases, which, paired with systematic development, can be achieved quickly and leads to significant modelling results.

Hydrological, hydrodynamical models

The modelling basis of evaluating the state of the environment, in the case of water as an environmental element, is the scale-independent, physically-founded hydrological and hydrodynamic system of models, which can be applied both for a large area and/or locally. In our work we relied on the models presented in literature as well as those already well known in the Hungarian engineering, research practice (DOLMAN et al. 2001), but essentially we developed and improved the distributed parameter model, and the software modules, of ARES (KONCSOS and SZABÓ 2003).

The hydrological river basin model integrates three sub-models:

- The first one is a physically described distributed parameter rainfall-runoff model, which provides three dimensional descriptions of the hydrological cycle of the surface and close-to-surface elements (run-off, infiltration, evapotranspiration, interception).
- The one-dimensional, non-permanent hydrodynamical model based on the Saint-Vernant equation, which is suitable for modelling the spread of the shallow water wave in rivers. In the ARES model, different simplified versions of the Saint-Vernant equation (diffuse wave, kinematic wave) can be used. The boundary conditions appear partly in the boundary sections of the river system, and partly in the form of linear confluences from the river basin.
- The third pillar is a two-dimensional hydrodynamical model integrated depth averaged, primarily for describing inundation phenomena and complicated (not examinable by a one-dimensional method) river spatial velocity distribution or lake problems.

The surface runoff process of the developed and applied ARES model was described by the 2D approach (DOLMAN et al. 2001; KONCSOS and WINDAU 1995). The watershed was divided into equal cells, approaching their surface with Bessel function on digital elevation data basis. On this surface, according to theoretical assumptions, the flow direction of the fluid is along the grade line. Based on this, the equation of the grade lines and the outflow side of a given internal point can be analytically calculated. By taking a large number of internal points into account, the ratio of the outflow of the sides of a cell (r_x, r_y) can be calculated. Water can flow from a given cell into the four adjacent ones, according to the elevation of the corners of the given cell. If the multiplied discharge of two adjacent cells is positive ($q_{x1} * q_{x2} > 0$), a stream is formed between the cells (if $q_{x2} = -q_{x1}$ then $q_{x1} * q_{x2} \leq 0$), as shown by Figure 1.

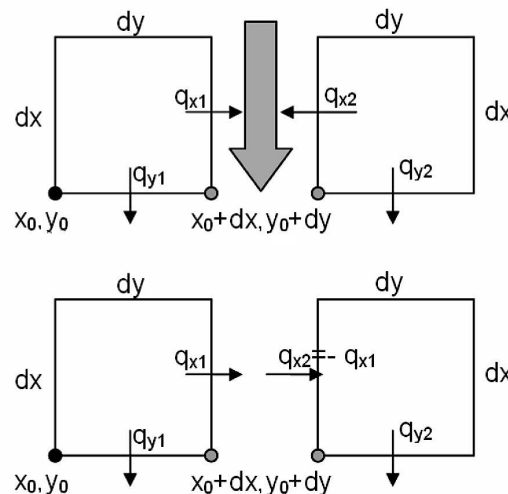

Figure 1. Cell linking structure in ARES for surface runoff

1. ábra Az ARES cellakapcsolódási struktúrája a felszíni lefolyáshoz

If a stream is formed between two adjacent cells it has to be followed by a stream computation element. According to the theory of ARES there is no possibility for the continuation of a stream in a surface runoff cell. This results in a graph structure and an unambiguous hydrological hierarchy.

The description of surface storage is based on the linear cascade theory:

$$\frac{dS_j}{dt} = (P - I - E)dF + Q_j - Q_{fj} - kS_j = F(t)_j - kS_j$$

where

- S_j is the stored water volume in cell j,
- P is precipitation intensity,
- I is interception,
- E is evapotranspiration,
- dF is cell surface,
- Q_j is water discharge to cell j from surface runoff,
- Q_{fj} is infiltration discharge in a given cell,
- $f(t)_j$ is input discharge time dependency of the cell,
- k is storage factor,
- kS_j is outflow discharge of the cell ($Q_o = kS_j$),
- t is time.

On the basis of equation (1) the model is dynamic (it describes processes that change in time), with the help of boundary conditions (Figure 2.).

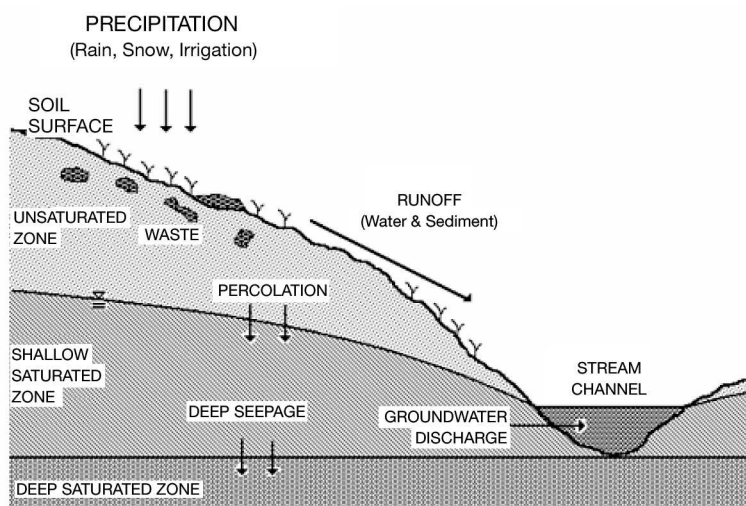

Figure 2. The modelled hydrological processes of the ARES model
2. ábra Az ARES modell modellezett hidrológiai folyamatai

The data of the boundary conditions (e.g. precipitation, air temperature, humidity) are also taken into account according to their spatial distribution. The processes induced by the boundary conditions, following the connection of the cells according to the run-off hierarchy, result in the time series of the watershed's downstream section (precipitation response) with the help of the balance equations, as well as in the expansion processes of the run-off wave in the river network identified by the model.

A crucial point in the application of the model is the digital terrain model (DTM), from which the spatial velocity distribution of the run-off and the river network of the watershed can be derived. In case of an accurate terrain model the real river system and the river network generated by the model are congruent. The DTM is a grid network, where the height of the terrain is given at its corner points. In previous applications of the ARES model, for the Tisza River's sub-watersheds that lie outside Hungary, for instance, a 600×900 m grid network was used; while on the Hungarian watersheds we aim at using DTMs with 50×50 or 250×250 m resolution (Figure 3.).

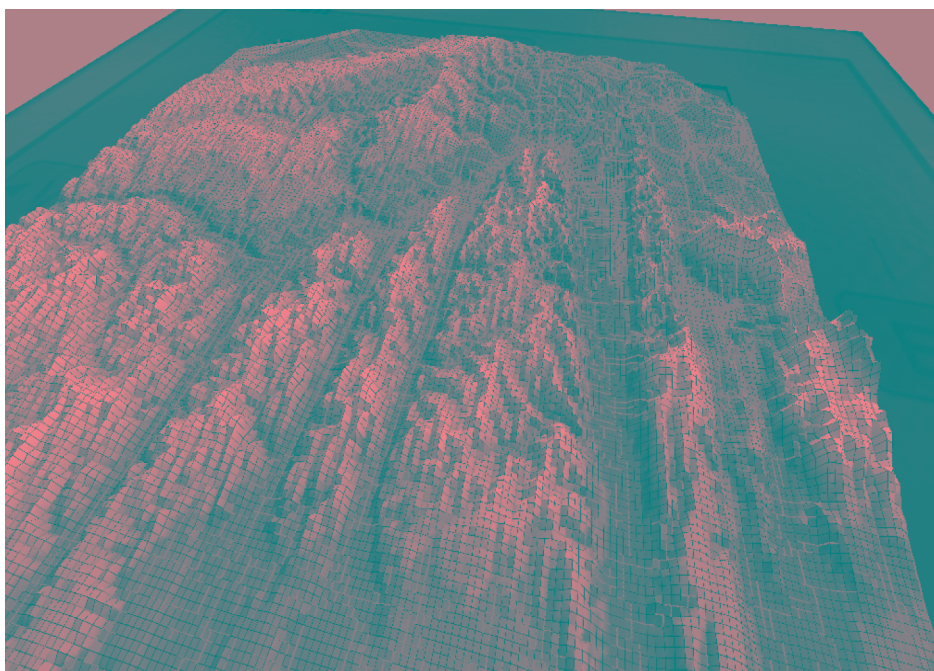

Figure 3. Generating the surface runoff system of the Zala river's watershed, based on DTM
3. ábra A Zala vízgyűjtő felszíni lefolyásrendszerének készítése a DTM alapján

Connecting the transport model to the ARES hydrological model

Within the frame of a development task that requires basic research we connected the ARES model to a water quality model that can be applied in a three dimension description as well, which we developed to describe the transport of dissolved and solid phase components. The crucial point of the model is the expected speed, which we

achieved algorithmically in a completely new way, with the hybrid application of numerical and analytical methods (KONCSOS and FONYÓ 2006).

The model is capable of describing the transport and biochemical transformations of the surface runoff, and infiltrating pollutants, on the watershed as well as in any discretional river system of the hydrological hierarchy. The modelled pollutants are the elements of the oxidation of carbon, of the cycling of phosphorus and nitrogen; bacterium *Coli*, oil, toxic materials that can be described by primary kinetics, and heavy metals (Figure 4.), on the basis of the QUAL II equation (US EPA 1985). The upper boundary conditions of the model are the flow rate of precipitation (measured) and evapotranspiration (calculated) and also the distribution-like (surface diffuse) point-like mass flow relating to the pollutant and the point-like mass currents appearing on any point of the river system. The model computes the transport in the unsaturated (three phase) layer of soil and, on its lower boundary surface, the mass currents of the groundwater pollution.

The essential question of the modelling is the computing speed. The computing speed of ARES on today's personal computers is 0.003–0.005 sec/km²/simulated year, i.e. it simulates the annual surface and close-to-surface hydrological processes of an area equivalent to the Great Hungarian Plain in about two minutes. The time step of the simulation is hourly, therefore the fine scale examination of transient phenomena of great speed is possible, but even trends of several decades can be analysed by the simulation technique.

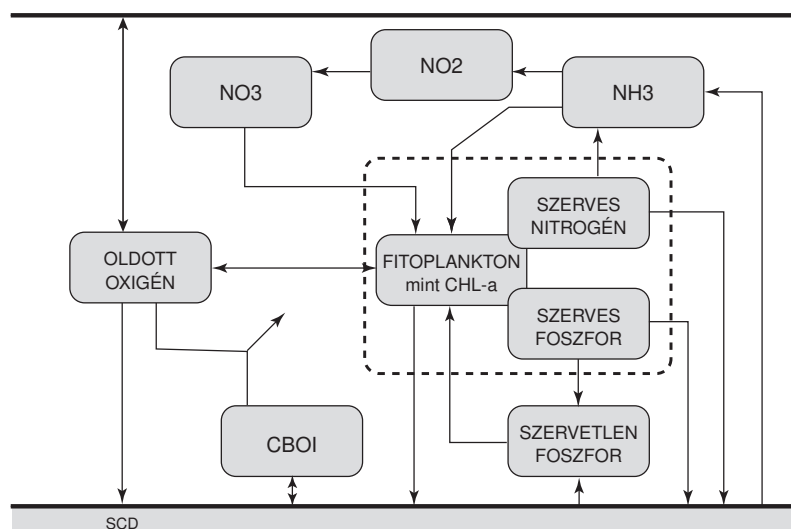

Figure 4. The structure of the QUAL2 model
4. ábra A QUAL2 modell felépítése

Database

The cornerstone of the task was to establish the uniform space information database (ETA), which supports the models developed for the environmental elements air, water and soil equally, and which ensures communication between the models. The programmatic basis of the system is the ESRI ArcView, which is considered an international and domestic standard by now.

From the space information data-base, a communication sub-programme – providing the internal data transport - generates information that can be utilised directly by the modelling. Two groups of data can be distinguished:

- (i) dispersion-like space information, e.g.
 - morphological data,
 - horizontal distribution of land use categories,
 - NDVI maps,
 - spatial distributions of geological and hydrogeological data (grouped by layers),
 - etc.
- (ii) point-like, time series like information, e.g.
 - detected time series of meteorological and hydrometeorological stations,
 - water quality monitoring data,
 - etc.

The database of ARES covers the watershed of the Tisza within the Carpathian Basin. Its topographical data, and land use, NDVI and hydrogeological basic maps have a $30 \times 30''$ resolution (which equates to about $600\text{m} \times 900\text{m}$), in a polar system of coordinates they contain NASA satellite detected data. We have developed the database necessary for the operation of the system for several smaller watersheds (e.g. Balaton, Sajó), where, due to the smaller size, a spatial description with a significantly finer resolution (50×50 m) is also feasible (Figure 3).

Case study

Application of the model was examined in the Zala watershed. Our aim, in accordance with what has been mentioned in the Introduction, is to analyse the factors impacting upon the non-point load, as an indicator. In this present essay, first the steps, and the results, of the computation of the load will be introduced and then the load to be expected in future will be estimated, using the possible, known scenarios of climate change as input data.

Lake Balaton is the largest shallow lake in Europe. It is 77.9 km long, 7.2 km wide and an average of 3.14 m deep. Its surface is 596 km^2 and its catchment area is approximately $5,776 \text{ km}^2$. The major inflow to the lake is the Zala River (Figure 5.) whose catchment area is approximately $2,702 \text{ km}^2$, almost half the size of the Balaton watershed. With its ratio of more than 50% within the entire lake phosphorus load, the Zala watershed plays a key role in controlling the water quality of Lake Balaton.

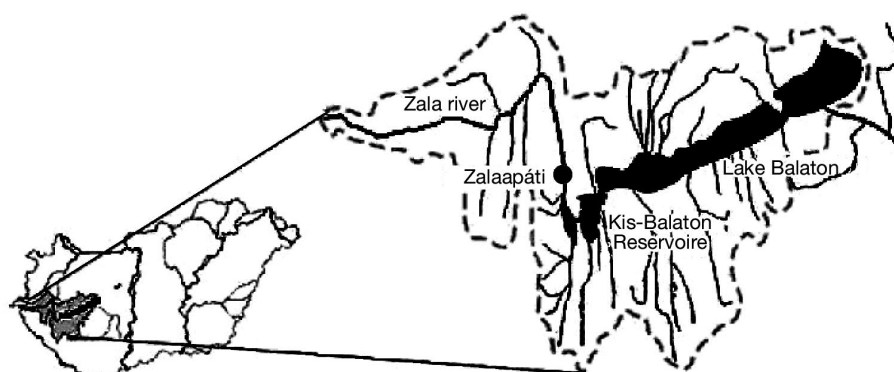

Figure 5. Lake Balaton and its catchment area
5. ábra A Balaton és vízgyűjtőterülete

The originally mezotrophic Lake Balaton showed signs of eutrophication in the 1960's and 1970's, due to the increased nutrient load from its watershed. A typical eutrophication gradient was noticed from west to east that is related to a decrease in internal basin sizes along the longitudinal axis of the lake. Between 1975 and 1981 the unit of phosphorus load in the Keszthely Basin was 2.47 g/m^2 (mostly from the Zala River watershed) while in the Siófok Basin it was 0.31 g/m^2 . After the implementation of a general water management plan for the lake, the concentration of biologically available phosphorus decreased by 50–60%. Similarly to international experience, a relatively slow, improving tendency was experienced in the water quality as a result of this decrease. In recent years the water quality of the lake has been good.

As a result of the general water management plan, improved wastewater treatment technology was introduced in the Zala River watershed. After the implementation of this water management plan, diffuse pollution became the major nutrient source in the Zala River watershed. Approximately 20% of the total phosphorus of the river's watershed comes from point sources, and 80% of it from non-point sources. In order to control the diffuse nutrient load, a dynamic distributed parameter phosphorus model was developed and adapted to the Zala River watershed. This diffuse nutrient model is based on physically described hydrological processes, combined with the description of erosion and phosphorus transport. The model was calibrated and validated for the Zala River watershed region.

Applied data

The applied dynamic, distributed diffuse nutrient model needed two types of data: spatial and temporal. For spatial data, land use and soil type digital GIS databases were used. For land use the 1:50 000 CORINE map was available for the Zala River watershed, for soil types the AGROTOPO 1:100 000 map was used. The latter one categorizes the upper 50 cm soil layer according to its physical specifications. Besides that, the basis of the rainfall-runoff model was a 250 m cell size digital elevation map, which determined the applied grid cell size for the spatial distribution.

Temporal data for the model were meteorological (temperature and precipitation), hydrological (water discharge) and water quality. Meteorological data were available for the examined watershed for 10 stations, as daily average temperature and daily sum precipitation. For the spatial distribution of these point data the Thyssen polygon method was applied. Water discharge and water quality as daily measured data sets were available for Zalaapáti (Figure 6).

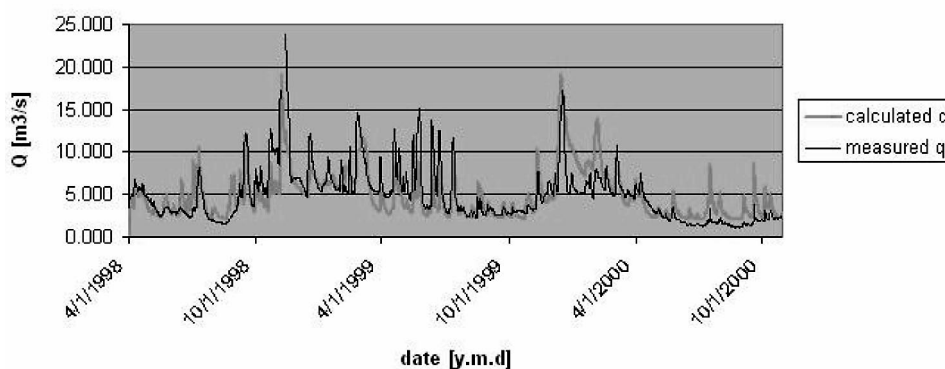

Figure 6. Water discharge validation for the Zala River watershed, in the Zalaapáti section
6. ábra A lefolyás validálása a Zala vízgyűjtőjén a Zalaapáti szakaszon

As water quality $\text{NO}_2\text{-N}$, $\text{NO}_3\text{-N}$, $\text{PO}_4\text{-P}$, total nitrogen and total phosphorus were measured. Despite the fact that the watershed has been monitored for decades, adaptable and consistent daily data time series as model inputs were available only for 1997–2000.

Hydrological computations

The basis of the diffuse nutrient transport description was a distributed parameter rainfall-runoff model (see 2.1). The model reduces the precipitation with interception, and then the remaining part is divided into surface runoff and an infiltrating part by using appropriate percolation models based on different principles (KONCSOS and SZABÓ 2003). Some of the water infiltrated into the soil will exit by evapotranspiration (depending on the humidity and the vegetation characteristic of the element), while the remaining water will form the subsurface flow (VARGA-HASZONITS 1997). ARES divides the soil into layers according to their physical characteristics. Based on the Richards equation summarizing the horizontal component of the calculated moisture transport along the layers, the flow rate in the channels can be computed. The major process of the model, however, was the description of the surface runoff.

Water quality and transport processes

The ARES diffuse nutrient sub-model was developed on the cell-size, distributed parameter model theory. The physically-based model description allows examination of the response of the Zala watershed to different environmental conditions. The basis of

the diffuse nutrient model was the erosion sub-model. The model describes two simultaneous processes: erosion and sedimentation:

$$\frac{dc_j}{dt} = \frac{L_{in,j}}{S_j} - c_j \left(\frac{Q_j}{S_j} + \frac{v_s}{H_j} \right)$$

where

- c_j is the concentration of suspended solids in cell j,
- H_j is water depth ($H_j=S_j/dF$),
- $L_{in,j}$ is nutrient load inflow of cell j ($L_{in,j}=L_{e,j}+L_{out,j-1}$),
- $L_{out,j-1}$ is the load outflow of cell j-1,
- $L_{e,j}$ is the erosion related load in cell j ($L_{e,j}=a*(\tau_b - \tau_{crit})$),
- τ_b is shear stress on soil surface,
- τ_{crit} is critical shear stress (below τ_{crit} no erosion occurs),
- a, n are model parameters subject to calibration,
- S_j is average volume of water in cell j in time interval $0-\Delta t$,
- V_s is settling velocity (subject to calibration),
- Q_j is average outflow rate in time interval $0-\Delta t$ for cell j.

Applying Taylor's expansion ($f(t) \approx a + b*t + d*t^2$) to L_{in} , equation (2) can be transformed into a structure similar to that of equation (1), and a recursive-eliminative technique can be applied for its solution (KONCSOS and FONYÓ 2006).

Data analysis shows that the correlation between particulate inorganic phosphorus (PIP) and suspended solids is very strong. Based on this, the applied PIP model theory is similar to the description of suspended solids.

The applied dissolved phosphorus model was based on the phenomenon that the balance between particulate inorganic phosphorus and dissolved phosphorus can be described by an isotherm. Previous research studies show that for the Lake Balaton region the type of this isotherm is the Langmuir isotherm. Applying the mathematical function of the Balaton calibrated Langmuir isotherm, the connection between PIP and dissolved phosphorus concentration can be described as a function of the PIP concentration. This description provides the theoretical background of the dissolved phosphorus model.

Results and discussion

Hydrological model

The examined time scale was 1997–2000, which was divided into two parts: calibration period (1997–1998) and validation period (1998–2000). For calibration, the initial value parameters came from either available data sets or from the literature. Calibration was carried out by a self-developed BLIND algorithm (KONCSOS and WINDAU 1995), which is a Monte-Carlo simulation based global optimisation method. Hydrological model calibration results show an excellent match between measured and calculated data. The

validation results reflect this (Figure 6), and the physically based model gives a good description of the natural watershed system. Under changing environmental conditions during the validation period, the calculated water discharge at the Zalaapáti outflow section of the watershed was well matched with the measured data.

Water Quality Transport Model

The aim of this present research was to elaborate, calibrate and validate a diffuse nutrient model for phosphorus, the key limitation factor in the Zala River – Lake Balaton system. There are three sub-models developed by the ARES for this purpose: the suspended solid sub-model described above, and the particulate inorganic phosphorus and dissolved phosphorus sub-models. These three sub-models were calibrated for the period 1997-1998, and validated for 1998-2000. For calibration the BLIND auto-calibration method described above (KONCSOS and WINDAU 1995) was used – with good results in all three cases. The first important step was the suspended solid material validation, which proved the parameter calibration for it. The results of the validated phosphorus models are, however, more important for water quality control. Phosphorus validation results are shown by Figure 7. and Figure 8.

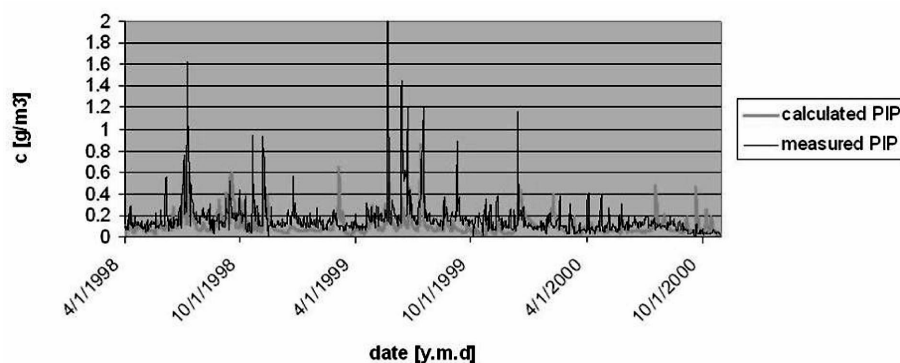

Figure 7. PIP concentration validation for the Zala River watershed at the Zalaapáti section
7. ábra PIP koncentráció validálása a Zala vízgyűjtőjén a Zalaapáti szakaszon

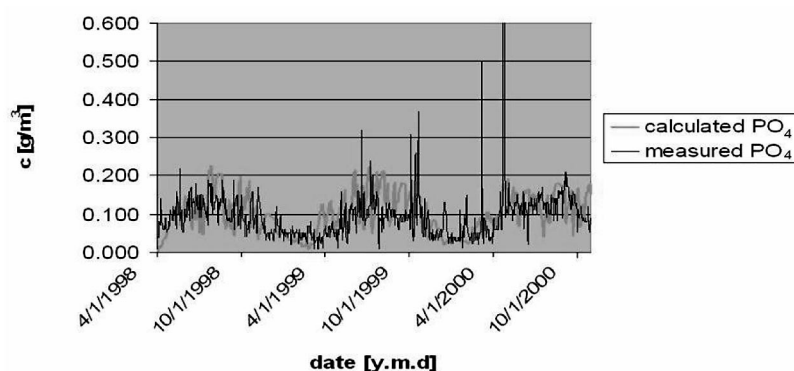

Figure 8. PO₄-P concentration validation for the Zala River watershed, Zalaapáti section
8. ábra A PO₄-P koncentráció validálása a Zala vízgyűjtőjére a Zalaapáti szakaszon

Validation results of the particulate inorganic phosphorus concentration (Figure 7) are well matched with the measured and calculated concentrations. Even peak values are simulated well in most of the cases. Dissolved PO₄-P validation results also match well; however, a few extreme peak concentrations were not reflected by the calculated concentrations, but, the PO₄-P model calculates smaller peak values well. For both phosphorus sub-model results we can assume that they follow the dynamics of the system, and provide good results for both the calibration and the validation period.

Future scenarios

Predictions and control scenario driving data of the watershed model came from the Intergovernmental Panel on Climate Change (IPCC, <http://www.ipcc.ch>) by using dynamic global (GCM) and regional climate models (RCM). After validation, the RCM data output generated the driving data of the ARES watershed model for predictions and control. With the help of the combination of different RCM and GCM models and IPCC scenarios four different predicted time series formed the output of ARES prediction runs for 2071–2100. The 1961–1990 period was used as reference, with driving data sets from RCM models. The time-series calculated by ARES refers to water discharge, suspended solids, particulate phosphorus and dissolved phosphorus (KONCSOS and FONYÓ 2007).

Table. The combination of GCM and RCM models and scenarios, together with the applied abbreviations

1. táblázat A CGM és az RCM modellek kombinációja és a scenáriók, az alkalmazott rövidítésekkel együtt

<i>Applied CGM</i>	<i>HadAM3p</i>	<i>ECHAM4/OPYC3</i>	<i>HadAM3p</i>	<i>ECHAM4/OPYC3</i>
Applied RCM	RCAO			
Simaliton period	Control (1961–1990)		Prediction (2071–2100)	
IPCC scenarios	ctl	ctl	A2 B2	A2 B2
Applied abbreviation	ctl	ctl	H A2 H B2	E A2 E B2

For predictions, model runs were carried out for the Zalaapáti section, on the basis of the calibrated and validated watershed model. Estimations for the whole Balaton watershed were calculated proportionally to the area of the watersheds. All data in this chapter refer to the whole Balaton watershed area.

In general, the results of water discharge indicated that the projected future streamflow will be lower than that of the reference period (Figure 9). The average streamflow of the Lake Balaton watershed in the reference period was 9.79 m³s⁻¹. The lowest projected annual average streamflow was calculated to be 8.19 m³s⁻¹ in scenario E A2, while the highest was 9.16 m³s⁻¹ in scenario E B2. The variation in the projected streamflow did not differ significantly from the reference period, however, in scenario M B2, the difference between the minimum and maximum streamflow was greater than in the other scenarios.

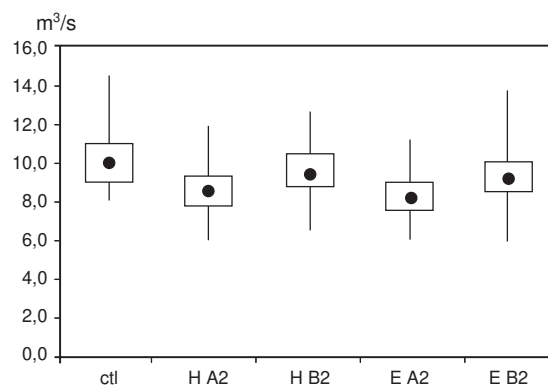

Figure 9. Average annual streamflow (m^3s^{-1}) in the Lake Balaton catchment: reference period (1961–1990) and future climate scenarios (2071–2100); median, quartiles and extremes
 9. ábra Átlagos évi vízhozam (m^3s^{-1}) a Balaton vízgyűjtőjén: az 1961–1990-es referencia időszakra és 2071–2100-as jövőbeli előrejelzésre vonatkozóan: medián, kvartilis és extrém helyzetek

Seasonal differences in streamflow showed a more complex picture, however. The typical tendency is that a decrease in the streamflow remained the same in almost all the simulations for all months (see Figure 10). The only exception was scenario H B2, where the spring – early summer (February–May) streamflow was slightly higher than in the corresponding reference period. The maximum difference was observed in March, when the projected streamflow in scenario H B2 was $14.7 \text{ m}^3\text{s}^{-1}$, while it was $13.8 \text{ m}^3\text{s}^{-1}$ in the reference period. A major decrease in the streamflow was seen in scenario E A2 during the late winter – spring period (January–April). The lowest projected streamflow in this scenario was in March, when the predicted streamflow was $9.3 \text{ m}^3\text{s}^{-1}$, while the reference streamflow was $13.8 \text{ m}^3\text{s}^{-1}$. During January–April the variation between scenarios was much higher than during the rest of the year. To explain the general decreasing tendency in streamflow, the year has to be divided into two periods. During late spring, summer, and early autumn (April–September) the reason is obvious: there is less precipitation and the average temperature is higher. Less precipitation causes less runoff, while the higher temperature decreases the runoff by increasing evapotranspiration. During late autumn, winter and early spring (October–March) the explanation is slightly more complicated. During this period the average projected precipitation is higher than that of the reference period. At the same time, the temperature is also higher. These two phenomena together cause slightly higher evapotranspiration, and much shorter periods with frozen ground. For the latter reason the infiltration is higher than in the reference period and it causes less runoff despite the increase in precipitation.

Particulate inorganic phosphorus (PIP) load results are presented in Figure 11. Seasonal analysis shows that during the late spring, summer and early autumn period (April–October), in general, the PIP load from the catchment was much lower than during the late autumn, winter and early summer period (November–March). The explanation of this phenomenon is based on the streamflow pattern, as the PIP load, in general, reflects the streamflow. The difference between the scenarios was much higher during March–April than in other periods of the year. The PIP load did not show clear

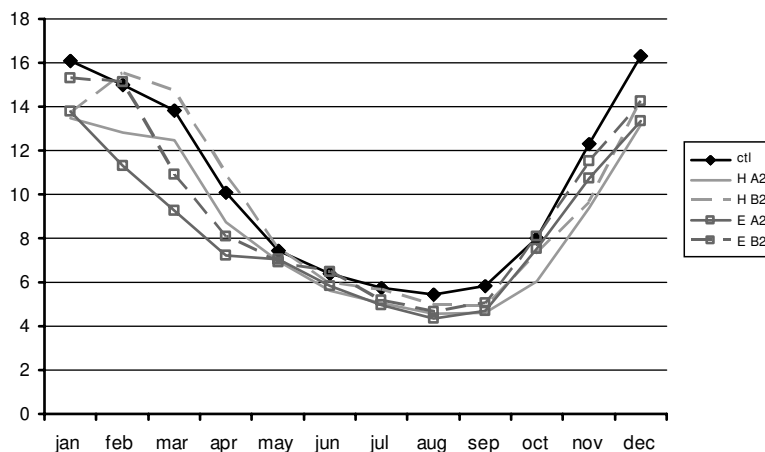

Figure 10. Median monthly streamflow in the Lake Balaton catchment (m^3s^{-1}): reference period (1961–1990) and future climate scenarios (2071–2100)

10. ábra A havi vízhozamok medián értékei (m^3s^{-1}) a Balaton vízgyűjtőjén: az 1961–1990-es referencia időszakra és 2071–2100-as jövőbeli előrejelzésre vonatkozóan

increasing or decreasing tendencies in the future climate simulation; each of them oscillates above and below the reference scenario. The maximum projected positive difference can be observed in scenario M A2 in October, when the monthly average load was 3,769 kg PIP, while that of the reference scenario was 2,154 kg PIP, more than one-third less than in scenario M A2. The maximum projected decrease was observed in the same M A2 scenario in March, when the monthly average load was 3,334 kg PIP, compared to the reference value of 6,587 kg PIP, almost double than that of M A2.

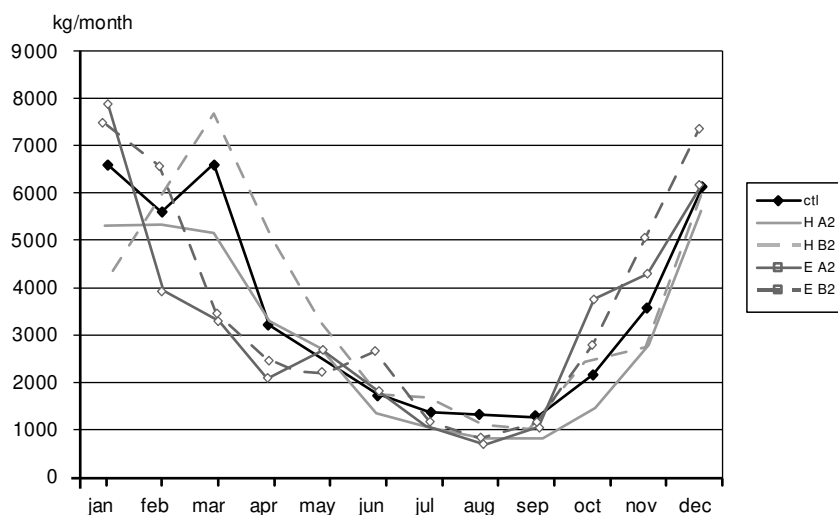

Figure 11. Median of mean daily particulate inorganic phosphorus load (kg month^{-1}) for the Lake Balaton catchment: reference period (1961–1990) and future climate scenarios (2071–2100)

11. ábra Az átlagos napi szervesetlen foszforterhelés (kg hónap^{-1}) medián értékei a Balaton vízgyűjtőjén: az 1961–1990-es referencia időszakra és 2071–2100-as jövőbeli előrejelzésre vonatkozóan

Dissolved reactive phosphorus ($\text{PO}_4\text{-P}$) load simulation results showed a clearer pattern (Figure 12.), with generally higher $\text{PO}_4\text{-P}$ loads during the period December–April and lower $\text{PO}_4\text{-P}$ loads between May and November. The maximum projected increase was observed in scenario M B2 in February, when the monthly average load was 3,119 kg $\text{PO}_4\text{-P}$ while that of the reference scenario was 2,043 kg $\text{PO}_4\text{-P}$, approximately one-third less than in scenario M B2. The maximum projected decrease was observed in the same H A2 scenario in October, when the monthly average load was 1,513 kg $\text{PO}_4\text{-P}$, while that of the control period was 1,872 kg $\text{PO}_4\text{-P}$.

The total phosphorus (TP) load (see Figure 13) was assumed to be a sum of PIP and $\text{PO}_4\text{-P}$. The seasonal analysis showed that, in general, during the late spring, summer and early autumn period (April–October) the TP load from the Balaton catchment was lower than during late autumn, winter and early summer period (November–March). The seasonal pattern in TP followed that of PIP. The variation between the different future climate simulations was much higher during March–April than in other periods of the year. There were no clear trends for the TP load in the future scenarios, each oscillated above and below the reference value. The maximum projected positive difference was observed in scenario H B2 in April, when the monthly average load was 8,523 kg TP while that of the reference scenario was 6,057 kg TP, approximately 30% less than in scenario H B2. The maximum projected negative difference was observed in the same M A2 scenario in March, when the monthly average load was 6,146 kg TP, while that of the reference period was 9,112 kg TP, approximately 50% more than in scenario M A2.

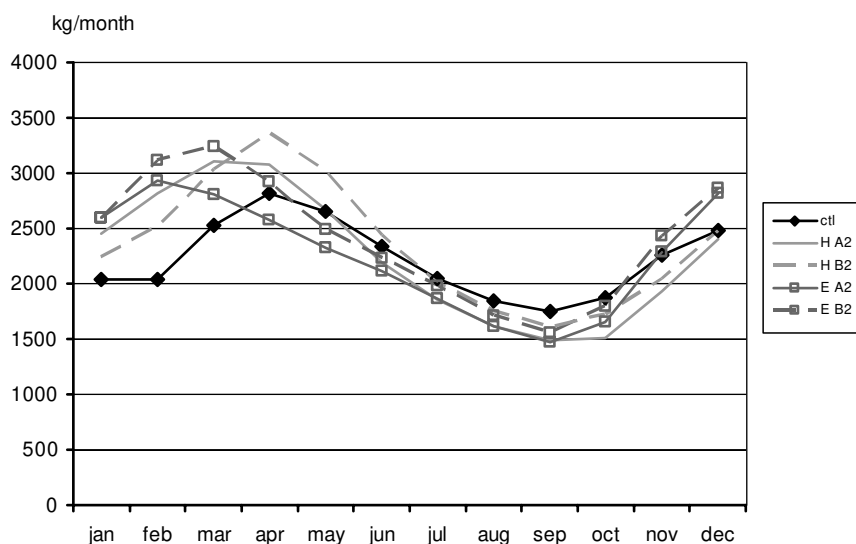
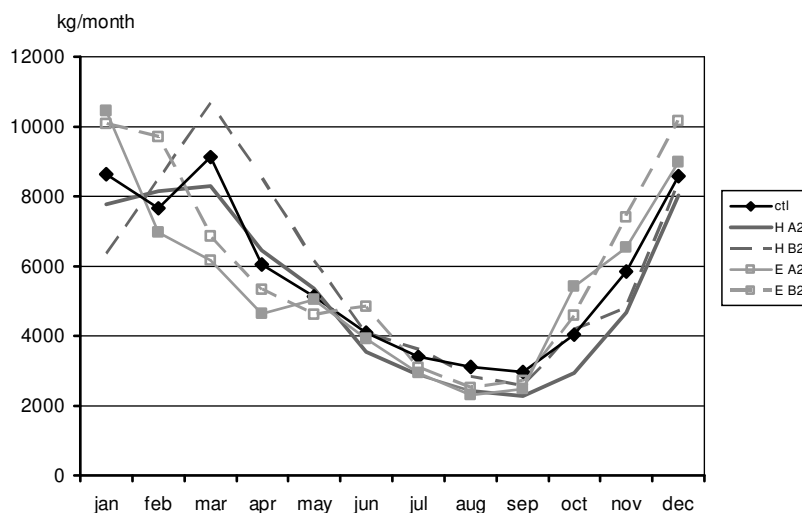

Figure 12. Median of mean daily dissolved phosphorus load (kg month^{-1}) for the Lake Balaton catchment: reference period (1961–1990) and future climate scenarios (2071–2100)

12. ábra A napi átlagos oldott foszforterhelés (kg month^{-1}) medián értékei havi bontásban a Balaton vízgyűjtőjén: az 1961–1990-es referencia időszakra és 2071–2100-as jövőbeli előrejelzésre vonatkozóan

Figure 13. Median of mean daily total phosphorus load (kg month^{-1}) for the Lake Balaton catchment: reference period (1961–1990) and future climate scenarios (2071–2100)



13. ábra A napi átlagos összes foszforterhelés (kg month^{-1}) medián értékei a Balaton vízgyűjtőjén: az 1961–1990-es referencia időszakra és 2071–2100-as jövőbeli előrejelzésre vonatkozóan

Conclusions

The above presented dynamic, diffuse nutrient model is a good means for calculating the non-point suspended solid and phosphorus load dynamics for the examined Zala River watershed. The presented ARES model is physically based, and its parameters meet the available measured data sets and literature values. Meanwhile, the physical basis of the model provides a reliable description of the watershed under different conditions, such as a change in land use type, climate change, and a decrease in applied fertilizer by agriculture.

Good calibration and validation results of the model show that the model works correctly for the Zala River watershed. As the model theory is independent of the watershed (except for the applied Langmuir isotherm for $\text{PO}_4\text{-P}$ concentration calculation), it can be applied as a general means both for larger and for smaller watersheds. The problems in the extreme peak calculation for dissolved phosphorus can be due to the fact that the watershed is relatively small (the average discharge of the Zala River is 3–4 m^3/s), and its dynamics fast, and it is possible that more frequently measured input temporal data would result in a better fit. The limitation of the modelling dynamics and spatial distribution was not the structure of the model, but the available data and the speed of the calculation.

Detailed analysis was performed for future climate conditions. Applied climate scenarios were the IPCC based A2 and B2 with GCM models HadAM3p and ECHAM4/OPYC3. RCM model RCAO and watershed model ARES were used for computations. As non-point loads, which form the dominant nutrient load, components of the watershed follow the dynamics of the precipitation; a temporarily detailed description of the hydrological processes was important – in consideration of the

relatively small size of the examined watershed. The present research focused on the phosphorus from non-point origin – the key element the eutrophication of Lake Balaton –, which is basically composed of the particulate inorganic phosphorus from erosion origin and the sorption-desorption affected dissolved phosphorus fraction. Results show that surface runoff and affluent water to Lake Balaton decreased by an average of 15% in all of the predicted scenarios, however, each scenario led to a different result. Seasonal examinations also predicted a general decreasing tendency, the difference between scenarios is considerable. The highest degree of decrease was predicted for late autumn, winter and early spring. The phosphorus load in general showed a decreasing tendency as well. The highest degree of decrease could be observed during the April to October period with an average value of 10–15%.

References

- DOLMAN, A.J., HALL, A.J., KAVVAS, M.L., OKI, T., POMEROY, J.W. (eds.) 2001: Soil-Vegetation-Atmosphere Transfer Schemes and Large-Scale Hydrological Models. IAHS Publications no. 270. Wallingford, UK
- KONCSOS, L., WINDAU, U. 1995: Application of a Comprehensive Decision Support System for the Water Quality Management of the River Ruhr, IAHS Symposia and workshop, Boulder, USA.
- KONCSOS, L., SZABÓ, Cs. 2003: Entwicklung ein physikalisches, numerisches Hochwasserabflussmodell. Symposium: Lebensraum Fluss-Hochwasserschutz, Wasserkraft, Ökologie. Wolgau, Oberbayern. pp. 122–131.
- KONCSOS, L., FONYÓ, Gy. 2006: Dynamic, distributed parameter non-point nutrient model for the Zala River watershed, Hungary. 10th International Specialized Conference on Diffuse Pollution and Sustainable Basin Management. September 18–22, 2006, Istanbul, Turkey
- KONCSOS, L., FONYÓ, Gy. 2007: Modelling of climate change on hydrological cycle and diffuse nutrient transport for the Balaton catchment. Harmonizing the Demands of Art and Nature in Hydraulics, 32nd Congress of IAHR, Venice, Italy, 01–06. 07. 2007. Theme B1.a, PAPER_1240 on CD attachment
- SOMLYÓDY, L., VAN STARTEN, G. 1986: Modelling and Managing Shallow Lake Eutrophication. Springer Verlag, Berlin.
- US EPA 1985: QUAL IIE. User's Manual.
- VARGA-HASZONITS, Z. 1997: Agrometeorology. PATE, Mosonmagyaróvár, Hungary