

HUNGARIAN

AGRICULTURAL

ENGINEERING

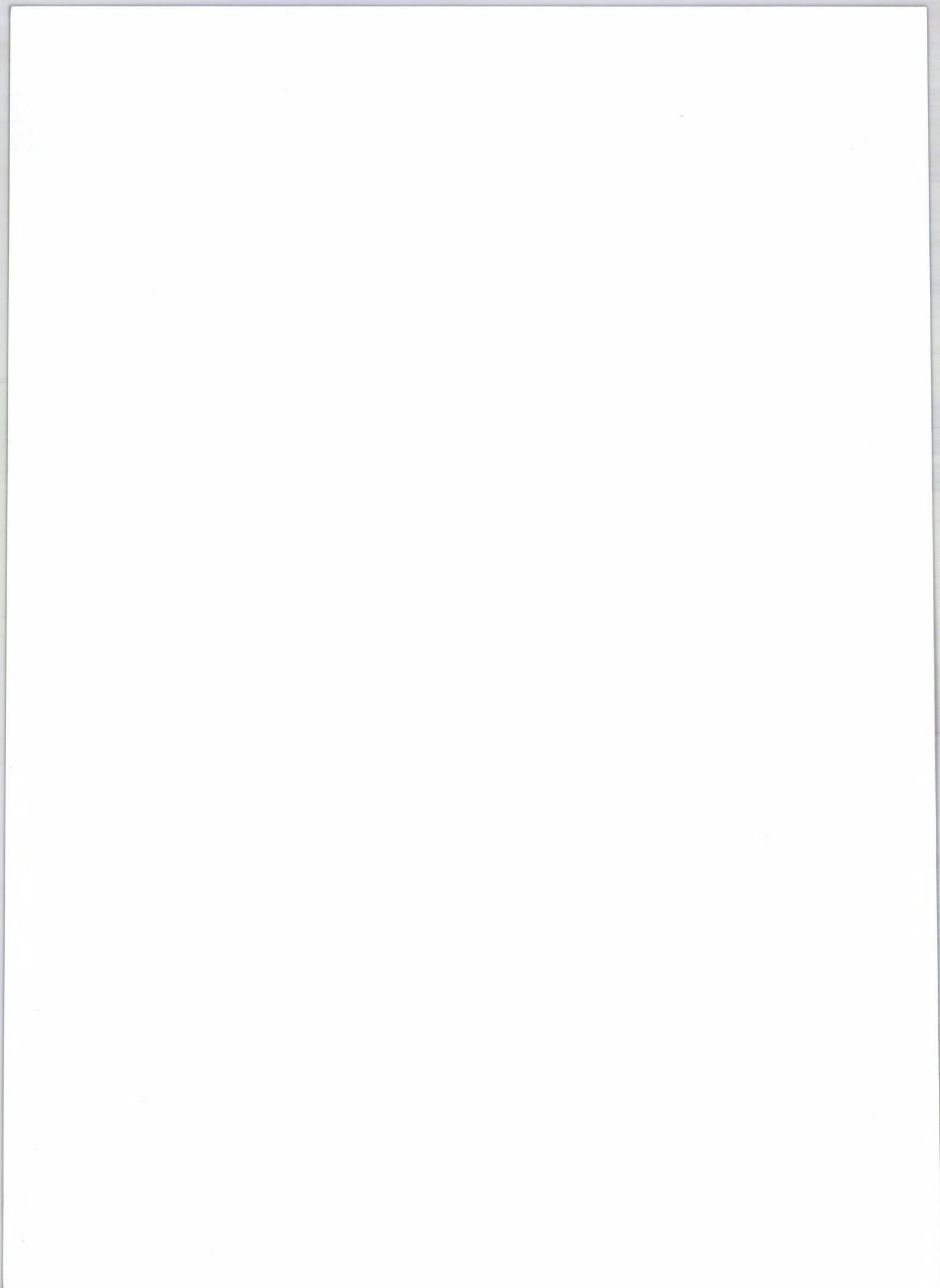





Hungarian Agricultural Engineering

N° 16/2003

Editor:

Prof. Dr. László TÓTH

Editorial Board:

Dr. Jenő CSERMELY

Dr. Imre DIMÉNY

Dr. István J. JÓRI

Dr. László FENYVESI

Dr. Péter SEMBERY

Dr. László TÓTH

Dr. János BEKE

Dr. Zdenek PASTOREK,
Czech. Republik

Dr. Jürgen ZASKE,
Deutschland

Dr. Vijaya G.S. RAGHAVAN,
Canada

Dr. Bart SONCK,
Belgium

**PERIODICAL OF THE COMMITTEE OF
AGRICULTURAL ENGINEERING OF
THE
HUNGARIAN ACADEMY OF SCIENCES**

Published by

Hungarian Institute of Agricultural Engineering

H-2100 Gödöllő, Tessedik S. u. 4.

Director: Dr. László FENYVESI



**St. István University, Gödöllő
Faculty of Mechanical Engineering**

H-2103 Gödöllő, Páter K. u. 1.

Dean: Dr. János BEKE



Gödöllő, December, 2003

PREFACE

The Agricultural Engineering Board of the Hungarian Academy of Sciences which supervises the development of this branch organises annually a conference at Gödöllő, which is the central place of the Hungarian agricultural scientific activity.

During the sessions, research scientist, developing engineers, experts of institutions engaged in agricultural engineering development strong in numbers the organizer, the hungarian universities and other higher grades of education, the research institutions: Hungarian Institute of Agricultural Engineering at Gödöllő, Faculty of Mechanical Engineering of the St. István University at Gödöllő and foreign guests give account of their results obtained in the research work and development of agricultural machinery.

This yearly English-Language publication the "Hungarian Agricultural Engineering", started at 1988, contains selected papers presented at the conference of 2003. We do hope that this publication will be found interesting to a big part of agricultural engineers.

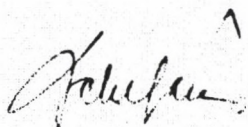

Dr. János Beke
Dean

Faculty of Mechanical Engineering
St. István University

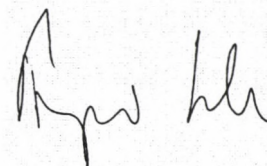

Dr. László Fenyvesi
Director

Hungarian Institute of Agricultural Engineering
Gödöllő

PREFACE

The Agricultural Engineering Board of the Council for Agricultural Sciences which supervises the development of the branch, convenes annually a conference at Guelma, which is the central place of the High School of Agricultural Sciences.

During the previous research sessions, the various experts of institutions engaged in agricultural engineering, working in various fields, the Institute of Agricultural Sciences and other bodies of the Council for Agricultural Sciences, have been in the field of Agricultural Engineering at Guelma for the development of the branch. The Board of Agricultural Sciences has been able to obtain a wide range of scientific and technical information from the various countries of the world.

The Board of Agricultural Sciences has been able to obtain a wide range of scientific and technical information from the various countries of the world.

The Board of Agricultural Sciences has been able to obtain a wide range of scientific and technical information from the various countries of the world.

THE STATIC AND DYNAMIC GROUND PRESSURE OF CASE IH QUADTRAC RUBBER BELT TYPE TRACTOR

I. J. Jóri¹ – Zs. Farkas¹ – Gy. Kerényi¹ – M. Szente² – G. Antos³

¹Budapest University of Technology and Economics

²Hungarian Institute of Agricultural Engineering, Gödöllő

³Integrated Crop Production System (IKR, Bábolna)

The development of rubber belt track was reported several time from the first appearance in Hungary. In the last decade we tested all Challenger rubber belt type tractors. The first rubber belt tractor with articulated steering system was developed by Case company. Very few result and experience are available from this system, so our aim was to investigate the tractive performance and static and dynamic ground pressure of CASE IH 9370 Quadtrac tractor.

Based on the result and experience of field test we can stated that the tractive efficiency is extremely good, the ground pressure values are better than the wheel type tractor's, but the rigid system of intermediate rollers and the articulated steering can cause some problems.

INFLUENCE OF THE FRONT AXLE SPRINGING TO THE TRACTOR DRAWING PARAMETERS

M. Szente – Zs. Kassai

Non-profit Co. of HIAE for QT., Gödöllő

The last year we tested the JOHN DEERE 6920S MFWD tractor by proxy the KITE Co. We made the drawbar tests with connected and disconnected front axle springing the next to different front axle loading. Our investments we determined the self-traction power requirement of the tractor on the road and the traction power requirement and front axle springing requirement on field. Determine the effects of weight (mass) distribution and travel speed on the followings in four wheel drive, rear and front wheel drive operation system (mode): self traction power requirement, the "wheel power" on drive shaft to front axle and on rear wheel hubs and rate of them, the traction characteristics of the tractor: drawbar pull, drawbar power, traction efficiency.

EFFECT OF BIOLOGICAL PRESERVATIVES ON THE QUALITY OF SILAGE PRESERVED IN PLASTIC TUBE (OTKA T 030031)

Z. Bellus¹ – J. Csermely¹ – J. Schmidt²

¹Hungarian Institute of Agricultural Engineering, Gödöllő

²University of West Hungary, Mosonmagyaróvár

Besides the natural ability to fermentation, the quality of silage is especially determined by the technical circumstances of the preserving procedure. The most important is the storage place, which has to meet a lot of conditions to produce and store silage and haylage of good quality with low loss. Among these conditions, the stimulation and sustain of anaerobic circumstances have to be mentioned as determinants. Further important condition is the quick fill of the silo with less live-labour. Moreover, the possibility of the mechanical loading and feeding the animals with silage is also considerable factor. Next important parameters are the size and the location of the silo, which must be meet the number and place of the animals. Finally, the cost of the silo also has to be taken into consideration.

THE DEVELOPMENT OF DRYING TECHNOLOGIES

M. Herdovics

Hungarian Institute of Agricultural Engineering, Gödöllő

Corn is the decisive fodder plant in Hungarian agriculture, primarily used as cereal.

The technology of post-harvest processing, whose most important elements are seed drying and storage are closely connected to the technology of producing corn.

Corn is grown on 1.2-1.3 million hectares in Hungary. The content of moisture at harvest time is 22-25 %.

Given the Hungarian climatic conditions, the grain – apart from a few exceptional years and one or two special species – must be dried.

The cost of drying might be decisive from the point of view of the efficiency of production. Its extent – depending on the content of moisture, the species and the applied technology of drying (performance, energetic features and utilization) – may reach 25-40 % of the full production cost.

The cost of drying is fundamentally influenced by the content of moisture of the grain, other parameters of the drying technology and the speed of moisture loss, etc.

COMPARISON OF BALE WRAPPING MACHINES

Z. Bellus

Hungarian Institute of Agricultural Engineering, Gödöllő

In the last years, as a result of the improvement in the quality of the agricultural production and farming, special machines developed for ensilage in Western European practice, appeared in Hungary.

The nutrient content and fermentation characteristics of fermented forage are important parameters in feeding of ruminants, as the demand of animals must be continuously cover both in winter (dairy cows and heifers) and in summer (beef).

The authors compared the bale wrapping methods of forage with low and high moisture content among technologies, based on the packing and pressing methods, which are regarded as the most modern preserving-storing technologies for forage at present. These up-to-date technologies give new aspects the feedstuff management and supply.

ON DETERMINATION OF THE HEAT CONDUCTIVITY OF CEREALS AND AGRICULTURAL GRIST MATERIALS

E. Judák – G. Kovács – L. Fogarasi – P. Korzenszky
Szent István University, Gödöllő

An instrument measuring the thermal conductivity values of different materials is shown in this article. The principle of measuring method is the determination of the heat flow in stationary state. The unknown heat conductivity of the material tested is measured by comparing it to the known heat conductivity value of a reference (so called standard) material. A precise data base of the thermal conductivity values of those materials used in the food industry has not been completed yet so the data that could be got from these measurements would be very important in the design of industrial equipment and the food processing practice as well. At the same time the knowledge of the real thermal conductivity values of the components, additives and products could be useful for the quality determination and control, too. In this paper, the basic functioning principle of the equipment setup and the basic functions of the software operating the measurement are discussed.

DETECTION OF SMALL SCALE MECHANICAL CHANGES BY ACOUSTIC MEASURING SYSTEM

J. Felföldi – A. Fekete

BKAE University, Faculty of Food Science, Budapest

On the field of the theoretical and applied research of mechanical properties of horticultural produces there is a need for methods to detect and evaluate the small scale (1-2 %) firmness changes caused by different types of load. The effect

of dropping, pushing, hitting the produces – e.g. during the harvest, transport or processing – or the effect of the turgor loss due to a surface injury cannot be measured by traditional (compressive) methods because of their destructive nature and/or the relatively poor repeatability. The acoustic firmness measuring method can be suitable for the mentioned purpose due to its very high reproducibility and non-destructive nature. The high-resolution acoustic measuring system (with automatic repeating feature) developed at the Physics-Control Department was tested for different produces. E.g. testing the turgor loss of carrot sample 0.1% change in firmness was detected significantly. The system was found to be suitable to determine other micro-changes of the produces as well.

SOME PROPERTIES OF PARSLEY LEAVES DRYING

J. Beke

Szent István University, Gödöllő

In this study a comparative dehydration process analysis of parsley leaves is reported on the basis of experiments within convective and microwave energy transport conditions. The carried out experiments proved, that the results coming from the industrial microwave drying experiences cannot be applied automatically, because the parsley leaves are living organisms and they react to microwave treatments differently than dead industrial materials. It was turned out that the stalk and the leaf proved different dehydration properties during drying. And also, the water removing process was depended on the applied energy transport method. The experiments showed more intensive drying process for the leaf in the convective conditions, while the drying rate of the stalk was higher in microwave field. The reason for this later phenomenon could be found in the effect mechanism of the microwave energy. Thus, applying a pertinent combination of convective and microwave energy a well efficient drying technology can be developed.

APPRECIATION OF AN COMPLEX ULTRASOUND SYSTEM ACCORDING TO THE SURVIVAL CELL COUNT

A. Lőrincz – M. Neményi

University of West Hungary, Mosonmagyaróvár

The decreasing of micro-organism cell count the most important task of the food industry. The killing of microbe no too difficult thing rather the preserve of essential food components is the heavy work. The modern microbe destructor technologies its effects goals only the pointed objects and don't acts the other essential food components. Our experimental work goals this philosophy with ultrasound. We examined the surviving cell count of *Saccharomyces cerevisiae* suspension. This cell suspension was of an closed liquid circuit system streaming with peristaltic pump. The cell count with manual and automatic detection system was examined and the experimental method based on vital staining with methylene blue and on the cell counting. The results gives a good possibility any cell phase analytical and continuous cell recreation system developing. This work is fundamental research.

PHISICAL PROPERTIES OF SEEDS OF VEGETABLES

N. I. Polyák - Z. Csizmazia

Centre of Agricultural Sciences University of Debrecen

The physical characteristics of seeds can strongly influence their movements in the seeding machine as well as in the air, it is essential to study them when constructing seeding machines. In this respect the size, size distribution, shape, mass, bulk density, real density, coefficient of friction and aerodynamic resistance

of grains are of great importance. Due to their irregular shape, determining the size of grains is a troublesome process. A precise description of grains has to include several sizes (length, width, thickness) and can be obtained from the screen size, roundness and sphericity of the grains. Many physical properties of grains are relevant during their movements in the seeding machines and in the air but coefficient of friction and aerodynamic resistance coefficient are the most important.

THE ENERGY BALANCE METHOD OF CHARACTERIZING SPRAYS FROM HYDRAULIC NOZZLES

I. Sztachó-Pekári

College of Kecskemét

It is not to discuss about the significance of technological, environmental protection and economical point of view of the precious spraying. It is necessary to know the process of the atomization, to know its exact mathematical description. Various theories have been proposed to explain the fundamental principle of the disintegration of a liquid sheet into drops compared with the pressure, the spray angle and the characteristics of the liquid: the surface tension, the viscosity, and the density.

The atomization equations have the next limitations: they are empirical in nature; they are defined to predict an average droplet size in a spray; and the nature average drop size is ambiguous.

ALTERNATIVES OF THE DOMESTIC AGRICULTURAL MACHINERY MARKET

J. Hajdú – L. Magó

Hungarian Institute of Agricultural Engineering, Gödöllő

In order to meet the requirements of the ecology and the market, the Hungarian agriculture needs technical and technological renewal. This requires a smooth and balanced agricultural machinery market, which takes the needs of both the farmers' and farms' needs into consideration extensively. The Hungarian agriculture's coverage with engine power is 1.8 kW/hectare. The density of tractors and combine harvesters is low. 48.8 hectares of land has to be cropped by 1 tractor, 1 combine harvester has to cover the area of 276 hectares. Compared on an international level, these figures indicate a very low level of coverage; they need to be increased.

The tasks of developing the mechanisation of Hungarian agriculture are dual:

- The improvement of coverage of agricultural machinery, and the increase of their density. The establishment of such machinery output which is capable of meeting the demands of the new structures of technology and property. This makes the increase of machine coverage essential, especially in the family-owned farms.
- The replacement of amortised and overused machines with new ones. The meeting of the demands of the technological modernisation.

The supply of the market of agricultural machinery must facilitate the realisation of these development objectives in such a way that it offers a both technically and financially suitable range for the farms willing to invest.

CHANGES IN SOME INDICES OF CAPITAL EFFICIENCY OF FARMS, SPECIALITY OF REGIONS

I. Takács

Szent István University, Gödöllő

The satisfactory efficiency of farm assets is very necessary for profitable production. Products with low gross margin are only

able to finance farm assets on a low level. Farm management theories have given adequate answers to this issue, but the farm practice is often unwilling to accept that. Based on the data of the Farm Accountancy Data Network of the Research and Information Institute for Agricultural Economics, some indicators of the efficiency of assets are examined in this paper, according to the form of farms and the different Hungarian regions. Statistical analyses of farm data can provide an opportunity to examine the necessary capital fixed in assets as well. (The research was supported by the T037519 theme of the Hungarian Scientific Research Fund)

WASTE MANAGEMENT IN THE WOOD PRODUCT INDUSTRY

M. Varga – G. Németh
University of West Hungary, Sopron

Exploitation and utilization of natural resources result in a tremendous quantity of waste materials. Their owners are very much keen on getting rid of these materials as fast as possible. That way certain materials are regarded to be waste materials or their owners -adopting a very comfortable attitude - label them as waste materials.

Disposal of waste materials, their placement, their storage always seems to be a very controversial issue. This particular issue resulted in being a very significant hardship even for the wood product industrial companies. The growing quantity of the industrial wood residue accompanied by the increasing risks from hazardous substances have progressively been endangering both our social and natural environment.

This particular situation required the clarification of significant issues of waste management.

Behavioral attitudes, norms, sophisticated systems, adoption of international principles, waste management issues, priorities, specific legal considerations and technological regulations need to be introduced. Meanwhile meeting these demands nowadays in Hungary requires more waste management policy awareness. The legal framework of conditions and requirements were laid down in XLIII.Act.2000. and relevant departmental orders such as 16/200 KöM. (Ministry of Environment and 98/2001 governmental order) are to be realized.

EXAMINATION OF FALSE HEARTWOOD FORMING IN BEECH TREE IN THE WOODS OF SEFAG RT.

J. Rumpf – B. Biró
University of West Hungary, Sopron

Beech is one of the most valuable native, hard broadleaved tree species in the woods of Hungary. It takes only 6,3% of the forest land area of the country, but its growing stock takes almost 12 %. Because of its great yield, beech is also a top ranking wood in quality wood production. **20 %** of the value of all the Hungarian woods comes from the **beech forests**. It has many-sided, valuable traits, so it can **fully comply with the threefold objective of woods**.

Within national cultivation circumstances it breeds in the most fully developed ecosystems, which best utilize the potentials of the sites. Beech wood has many good traits, so its wood varieties can produce as good returns from sales as the varieties of oak and conifers. Beech trees typically **do not produce heartwood stain**. The inner part of the trunk however often forms false heartwood. False heartwood can be **sound or diseased**.

False heartwood forming is the most important structural and color anomaly of the living beech. False heartwood significantly reduces the value of tree stand (23–27 % of yield class), thus greatly affecting the **economical character of beech production**.

APPLICATION OF PRISMS FOR SOLAR COLLECTORS

I. Patay – Gy. Babák
Tessedik Sámuel College, Szarvas

One of the most important questions is the level of collected energy concentration in the direct solar applications. There are some well-known optical devices to concentrate the solar energy (mirrors, lens, parabolic mirrors etc.). As a theoretically new possibility, we tested special prisms made of optical materials with different geometry for the same function. If the geometry of prisms is well constructed, the solar energy is focusable in a relatively wide range of angle of incidence. The main task is to determine the relations between the geometrical parameters and the level of concentration. The results of the study apply to a two-dimension model but can be applied to any different prism geometry as well.

COMPARATIVE ENGINE TESTS AND ENVIRONMENTAL EFFECT ANALYSIS OF FUELS MADE OF ANIMAL FAT AND VARIOUS KINDS OF PLANT OILS

L. Jánosi¹ – J. Hancsók² – F. Kovács²
¹ Szent István University, Gödöllő
² University of Veszprém

Many organizations have been dealing in Europe with renewable energy sources based on biomass with growing activity since 1988. We can say that all of the EU member states are committed using alternative fuels [1, 2]. Production and application of biological fuels is free opportunity on the market, and their use serves several purposes at the same time. For example it is a source for supporting agriculture, it reduces Europe's dependence on other countries concerning energy supply, it has a favourable effect on the environment, upgrades the CO₂ management of the atmosphere etc.

Although remarkable steps have not been done in this topic in Hungary during the past decade, there is a need to deal with the production and use, because after Hungary joins the EU, the same regulations will be valid as for the present member states. On this field we have a quite big lag, comparing Hungary even to the other countries which will join the EU together with us.

RENEWABLE ENERGY FROM HAZARDOUS ORGANIC WASTE

K. Kovács^{1,2} – I. Kalmár³ – Z. Bagi^{1,2} – P. Valastyán⁴,
¹University of Szeged
²Institute of Biophysics, Biological Researcher Center, Hungarian Academy of Sciences, Szeged
³Tessedik Samuel College, Mezőtúr
⁴Unicotech Kht., Szeged

Effective treatment of agricultural and organic waste from various sources is a task of European dimension. The leakage of organic waste into the environment and into the ground water supply represents a public health concern. Anaerobic digestion (AD) offers an environmentally and economically feasible solution to the waste treatment problems. Biogas is produced concomitantly, which contributes to the economic feasibility of the system. Several technologies have been developed and applied for AD worldwide. The current energy supply system ignores the potential of exploiting renewable energy sources.

The general goal of this project is to develop and demonstrate the technical and economic benefits of a complex utilization of renewable energy sources in a predominantly agricultural region. The final product will be a network of small power plants that supply energy from diversified renewable sources via AD.

DOMESTIC EXPERIENCES OF OPERATING WIND GENERATORS

L. Tóth – G. Horváth – G. Tóth – N. Schremppf – L. Fogarasi
Szent István University, Gödöllő

The possibility of the wind energy utilization in power station system can be proved with the help of the examples realized already in Hungary as well. The most characteristic equipment is the wind power station of 600 kW established in Kulcs. At the same time, wind generators are working in Inota (established with power of 250 kW) and another station of 2×600 kW nominal power in Mosonszolnok established at present time. There was experience got during the operation of circa 26 months carried out in Kulcs with the wind generator and in Inota – of 32 months. The foregoing results proved that they have operated according to the trends determined by the researchers and produced energy.

ENERGETIC MODELLING OF WHEAT KERNEL HARDNESS

A. Véha – E. Gyimes
Szeged University

The authors (VÉHA, 1996) have been working on determining the kernel hardness of different wheat varieties by means of an objective physical unit of measurement. The previously used vitreosity percentage proved to be rather subjective, vague and fluctuating, although kernel hardness is of great importance when the qualities and milling technologies of different varieties are evaluated (VÉHA–GYIMES, 1999). Kernel hardness affects flour quality, batter production and baking to a great extent (MATUZ et al. 1999). Nowadays more researcher trying an experiment to determine of the grinding energy demand in case of wheat breaking (CAMPBELL – WEBB, 2001 as well as PASIKATAN et al, 2001).

Determining the physical hardness of wheat kernel has been made possible by introducing the notion of "grinding resistance" (VÉHA–GYIMES–BÖLÖNI, 1998), which has been identified as specific surface grinding energy demand (e.g. kWh cm⁻² and kJ cm⁻²). This has been done by making use of the results of other investigations into grinding cereals (BÖLÖNI, 1962). For practical purposes it has been determined with the help of a laboratory hammer mill, by measuring power capacity demand, grits mass flow and the specific surface increase of grits. Specific grinding energy demand ed (kWh t⁻¹ or kJ t⁻¹), which we have referred to the mass unit of grits, can be calculated from this (VÉHA–GYIMES, 2000).

INFLUENCE OF LOAD ON THE FRICTION COEFFICIENT BETWEEN STEEL AND POLYAMIDE ROLLING COUPLES

R. Cotetiu¹ – A. Cotetiu¹ – O. Eberst¹ – G. Kalácska²
¹North University of Baia Mare, Romania
²Szent István University, Gödöllő

Taking the a great number of scientists working on to replace the steel materials with non-metallic materials into account, this paper presents new experimental results regarding the variation of the friction coefficient values in rolling couples, with steel and several polyamidic material contact.

THE APPLICATION OF THE BENCHMARKING METHODS FOR RATIONALISING THE LOGISTICAL COSTS OF THE AGRICULTURAL MACHINERY

A. Tátrai
Business College of Budapest

Knowing logistical costs can help at saving them. Nevertheless, statement of logistical costs is very difficult in field of

utilization of agricultural machinery, too. To solve this problem, it seems to be practical, to take results of foreign experts in this field, into consideration. Use of benchmarking, as a method, the foreign results can help the Hungarian specialists in their efforts, to economise costs.

THE POTENTIALS AND LIMITATIONS OF JUST IN TIME (JIT)

J. Benkő
Szent István University, Gödöllő

An important aim of the material and stock management is to satisfy continuously the material needs according to the pace of production. Knowing the production plan, the material norms and the supply sources, it is possible to plan with precision the amount of material needed for the production of a given period. Nevertheless, problems can arise in the process of acquisition and provision of material. On the one hand, such problems can occur due to unforeseen and unplanned changes in the production plan and due to uncontrollable factors of the supply sources on the other.

OPERATION FEATURES OF PNEUMATICALLY CONTROLLED LINEAR CYLINDER IN THE VIEW OF ENERGY SAVING

Zs. Bartus – L. Jánosi
Szent István University, Gödöllő

To work with pneumatic energy is not a cheap way of solution but it is indispensable to use nowadays and it will be the same in the future. We will apply pneumatic systems in the field of industry, agriculture etc. so it is our main and further task to look for energy-saving solutions. This paper proves that we can find device which can offer an appropriate solution in the field of air consumption reduction. The laboratory tests approve that with an inside-controlled valve we can adjust the pressure stepless which will be the most favourable for the cylinder in both directions in the view of energy-saving. In addition to this the laboratory tests were able to show us the operation features of pneumatically controlled linear cylinder. In this way we were able to see that the inside-controlled valve had a favourable influence on the whole of the operation of pneumatically controlled linear cylinder.

Key words: Pneumatic cylinder, Pneumatic energy, Energy-saving, Inside-controlled valve, Operation feature, Power loss

STUDIES ON THE DINAMICS OF TRUNK SHAKERS

E. Horváth
Szent István University, Faculty of Horticultural Science, Budapest

Earlier investigation always assumed that the tree is clamped in the soil. As a consequence, in the governing differential equation only the mass of the tree trunk was taken into account using different, mainly rough estimation methods. However, our measurements have shown that the soil-root systems an important part of the vibration system and, therefore, it cannot be neglected. Using the measurement results, a new calculation method was developed to determine the effective mass reduced to the attachment point. A new tree model is also developed allowing different kinds of motion (elastic, tilting and lateral displacements). The equilibrium of horizontal forces was newly formulated.

The experimental and theoretical results contribute to a better understanding of the dynamic behavior of tree shakers.

INCREASING THE RAW MATERIAL BASIS OF BIO-BRIQUETTE PRODUCTION BY USING NEW MATERIALS

B. Marosvölgyi – D.I. A. Vityi – R. Ivelics – L. Szűcs Szabó
University of West Hungary, Sopron

Recently the Hungarian biobriquette production using only sawdust and shavings from the secondary wood industry is not significant. There is an increasing interest in biobriquette as an environmentally-friendly fuel. As taking into consideration the limited amount of wooden residuals – which can be the bottleneck of the production – we have established a pilot briquetting plant. We made experiments with different lignocelluloses (energy grass, miscanthus, wooden material from energy plantations, energy hemp, seed-coat, etc.) and produced briquette partly from pure test materials partly from the mixture of these materials and conventional wooden raw materials.

Researchers report on the results from the experiments, experiences and problems on the briquetting process of new raw materials and the qualitative parameters.

QFD METHOD ADOPTION TO SELECT SOIL TILLAGE SYSTEMS

M. Birkás¹ – L. Csík²

¹Szent István University, Gödöllő

²MEZŐGÉP Ltd.

The requirements in soil tillage have any differences under eras, likewise the ways to perform the goals. In this paper soil tillage systems are evaluated by the simplified, two-stepped QFD analysis according to fulfilling of the requirements. In the 1st stage 7 tillage systems are examined with four principal factors – yield assurance, cost saving, environment conservation and surface aesthetics – and systems are ranked on the basis of their conformity. The alternatives of the most conform system are to

evaluate in the 2nd stage with supplementary factors – tillage faults, less costs, moisture loss, production risk, mulching – to raise the most suitable variant. The QFD method is a fairly impartial analysis. It helps to select the most suitable tillage system in a given arable site and economical circumstances. It gives data to the producing and trading firms about the tillage trends to determine the improvement of the direction line. Work is the first step to adopt QFD method in soil tillage relation. This paper presents results of the research programs supported by OTKA-34.274 and FVM 15.031/2002.

A NEW CHALLENGE IN ENVIRONMENTAL POLLUTION: ELECTROSMOG

P. Szendrő¹ – A. Szasz²

¹Szent István University, Gödöllő

²Strathclyde University, Glasgow, Great-Britain,

Electrosmog is a rapidly spreading, new kind of electromagnetic environmental pollution in our age. It poses a new challenge in the on-going history of direct human action on the actual ecosystem. While this is the sort of environmental pollution, which is imperceptible to biological systems, these interactions are still capable of disrupting those systems' inner orders and coherent, metabolic processes. The entire phenomenon underlies solely the electromagnetic interactions in every biological systems, and so in the plants. Electrosmog could effect on both the advantageous-beneficial and harmful-damaging kind on the bio-systems, organisms. In our present work we would like to present some of the effects and its presence in agricultural practice. After discussing some basic effects, we are more emphasizing the benefits and usage of the phenomenon than their risks. This research has been supported by OTKA (Hungarian Scientific Research Found) T-043385 and by "Modelling of Processed Plant Structures" research group of Hungarian Academy of Sciences.

THE STATIC AND DYNAMIC GRIND
PRESSURE OF CASE IN QUADRAC RUBBER
BELT TYPE TRACTOR
J. J. ...
...



PART II.

SELECTED SCIENTIFIC PAPERS



The first part of the paper is devoted to a study of the static and dynamic pressure of the rubber tread of a tractor tire. The results of the tests are presented in the form of graphs and tables. The second part of the paper is devoted to a study of the effect of the tread pattern on the rolling resistance of the tire. The results of the tests are presented in the form of graphs and tables. The third part of the paper is devoted to a study of the effect of the tread pattern on the wear of the tire. The results of the tests are presented in the form of graphs and tables.

THE STATIC AND DYNAMIC GROUND PRESSURE OF CASE IH QUADTRAC RUBBER BELT TYPE TRACTOR

I. J. Jóri¹ – Zs. Farkas¹ – Gy. Kerényi¹ – M. Szente² – G. Antos³

¹Institute of Machine Design, Budapest University of Technology and Economics

²Hungarian Institute of Agricultural Engineering, Gödöllő

³Integrated Crop Production System (IKR, Bábolna)

Introduction

In the last decade the tractor with rubber belt track system had some popularity in Hungary. The main advantage of this tractors is a good combination of wheel and track type running gear e.g. low ground pressure, high tractive efficiency, excellent stability, good steering capability, on-road mobility and high speed range for transport.

In the last couple of years we made laboratory or/and field test with all Challenger tractors.

So the aim of the present project was to investigate the tractive performance of CASE IH 9370 Quadtrac tractor and to evaluate of the static and dynamic ground pressure of rubber belt type tractor with articulated steering system.

Methods and material

Place and time of field test:

- Dráva Ltd, Görgeteg, October, 2000.
- Tedej Ltd, Tedej, August, 2002.

Tested machine:

- CASE IH 9370 Quadtrac rubber belt tractor with articulated steering system.

Test sites:

- Görgeteg: sandy soil, corn stubble.
- Tedej: clayey loam soil, loosened and mulch cultivated wheat stubble.

The aim of field test:

- determining the effect on ground pressure of different running gears by penetrometer
- determining the drawbar power of CASE IH 9370 Quadtrac tractor.

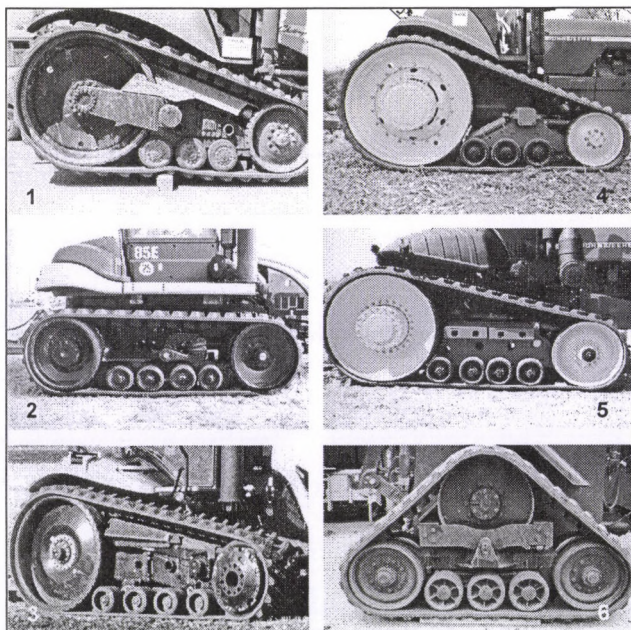

Figure 1

Different type of rubber belt running gear (1-3 CAT Challenger, 4-5 John Deere, 6 CASE IH Quadtrac)

The first topic was the measuring of tractor's axle load named static ground pressure on flat concrete surface at standing position by electronic scales (PAT SAW 10 C).

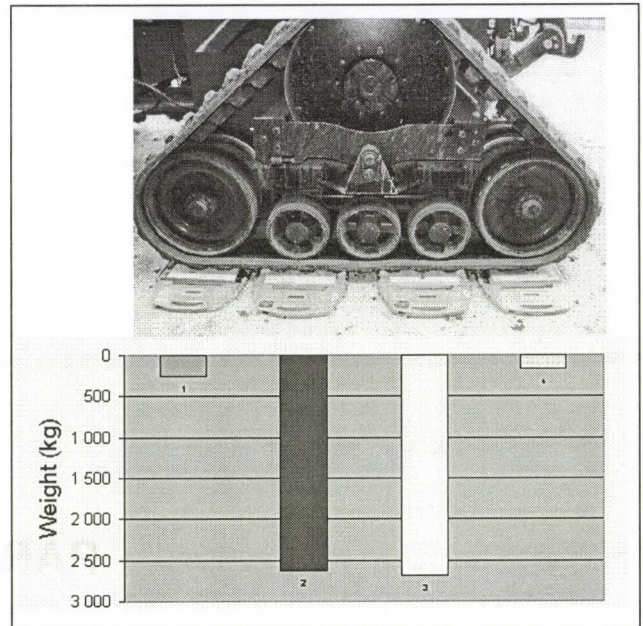

Figure 2

The weight distribution beneath the running gear

The second topic was the measuring of the effect on soil compaction occurs by moving tractor named dynamic ground pressure. The soil compaction was measured 10 times repetition before and after of tractor passes by EJKELKAMP digital cone penetrometer beneath tread lugs. The second series of measuring were done by the same method, not only beneath tread lugs but beneath interlugs also.

The drawbar test of tractor was done by OECD code. Because of very high drawbar pull we was not able to use our standard „braking tractor”. For braking the test tractor we used the non – tested tractor with a mounted subsoiler. The HBM 200 dynamometer was placed between the tractors by steel cable and was connected to test car by wire.

The measuring devices (HBM Spider, Note book etc.) are built in the MITSUBISHI L300 4 WD test car.



Figure 3

Drawbar test of CASE IH 9370 Quadtrac tractor

Result and conclusions

Evaluation of field and laboratory test result of CASE IH 9370 Quadtrac tractor the following conclusion can be drawn:

- The drawbar power efficiency was 77,3 % which is a highly accepted value. The pull/weight ratio at 5 % slip was 0,516 daN/kg and at 10 % slip was 0,535 daN/kg. These advantageous values were getting from the good weight distribution and the large contact area of rubber belt running gears.

Table 1 Result of CASE IH 9370 Quadtrac tractor drawbar test
 Test place: Görgeteg Test site: Sandy soil, corn stubble

Speed range	Speed [km/h]	Pull [kN]	Power [kW]	Slip [%]
4	5.7	109.0	172.6	12.0
5	6.5	105.4	190.3	8.0
6	8.0	85.6	190.2	3.0
7	8.8	77.3	188.9	2.5
8	11.6	57.5	185.2	2.1

Drawbar characteristics:

Type	Weight [kg]	Slip [%]	Pull [kN]	Pull-Weight Ratio [daN/kg]
CASE IH 9370 QUADTRAC	20170	5-10	104-108	0.516-0.535

- The static ground pressure values getting from scaling of axle loads were higher than the average value (0,37 bar) counting by the whole contact area, The disadvantageous weight distribution was caused on the one hand by the triangle shape running gears and on the other by the rigid intermediate roller system.

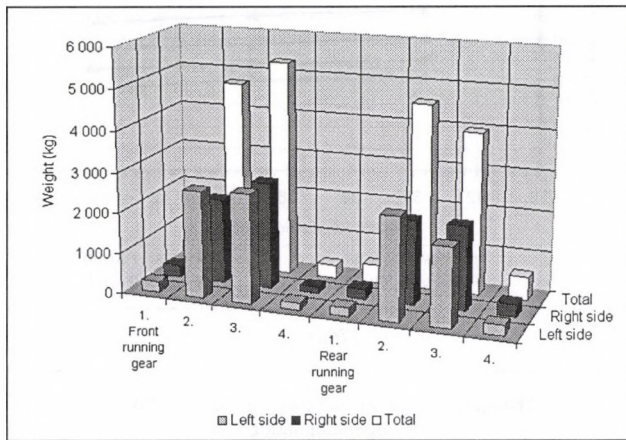

Figure 4
 The weight distribution beneath the tractor

- The dynamic ground pressure distribution charts based on soil compaction measuring, show the following:
 - the running gear system of the tractor has some advantage because the ground pressure values were below 3,0 MPa even after four passes,
 - evaluating the effect of multiple passes was found that the first two passes occurred similar compaction and the third-fourth passes increased it a little bit,

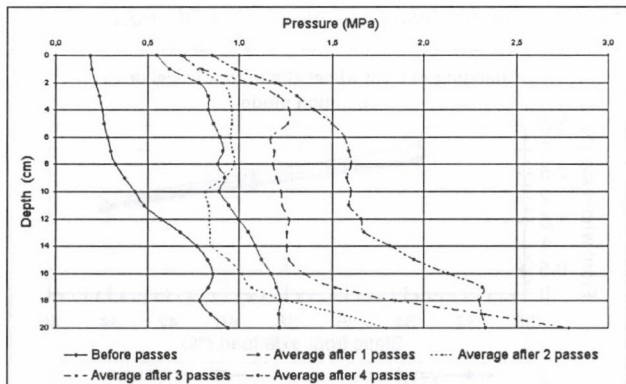

Figure 5
 Soil compaction after passes

- comparison the compaction effect of tread lug and inter lug was found a 0,2 MPa higher value beneath the tread lug,

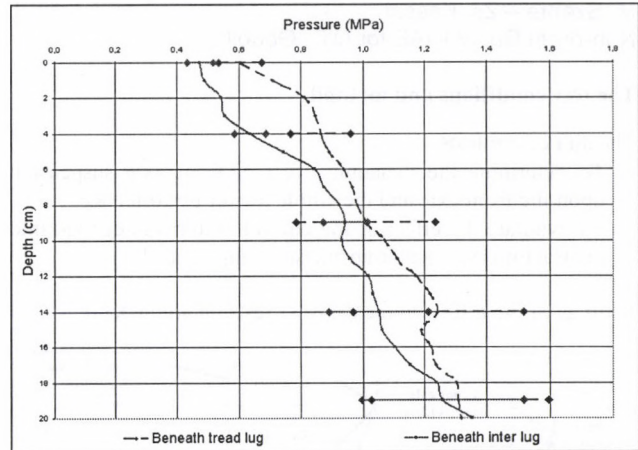

Figure 6
 Soil compaction beneath the tread lug and inter lug

- summarizing the result and experience of rubber belt running gear with articulated steering system we can stated that the drawbar efficiency of the new system is higher. The effect on ground pressure of the rubber belt system has two different cases. The average value of ground pressure counting by the total weight and contact area is good, but the axle load distribution of running gear is disadvantageous because of the rigid intermediate roller system. The rigidity of this system can cause problem if the running gear goes up to an uneven part of the surface. The rigid rubber belt system occurs some problem at steering situation also. When the steering angle is high for example on headland the rubber belt makes a strong smearing effect on the soil surface. The rubber belt system tractors which have a special final drive system with differential steering has no similar problem.

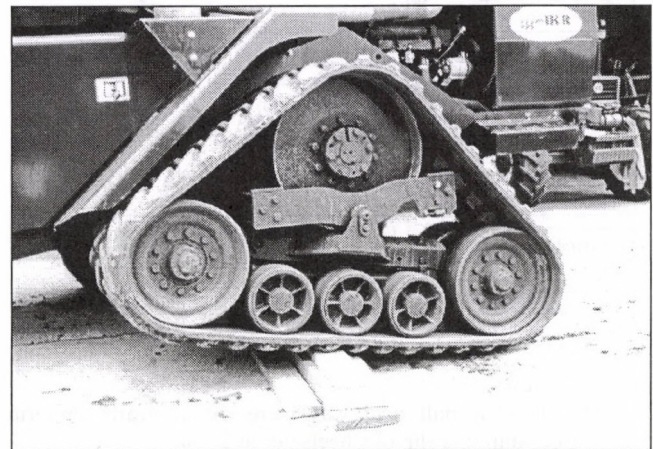

Figure 7
 The rigid running gear system on the obstacle

Based on the result and experiences of CASE IH 9370 Quadtrac rubber belt tractor we can stated that this types could be useful for Hungarian farmers thanks to the extremely good tractive capability and advantageous ground pressure values.

Acknowledgements

The authors wish to acknowledge the financial grant from the Ministry for Agriculture and Rural Development and the Hungarian Scientific Research Fund (OTKA).

INFLUENCE OF THE FRONT AXLE SPRINGING TO THE TRACTOR DRAWING PARAMETERS

M. Szente – Zs. Kassai

Non-profit Co. of HIAE for QT., Gödöllő

The test conditions and method

The aim of our tests:

- To determine the dynamic effect of front axle suspension upon the front axle and the whole tractor performance.
- To evaluate the effect of the control systems integrated into the tractor (IMS, auto transmission, slip control)

Settings of the tractor to the drawbar tests on arable land:

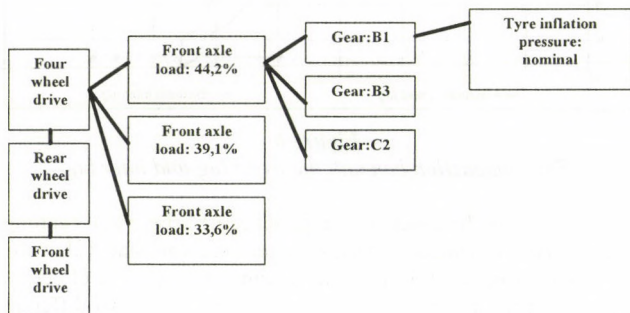

Scheme of the measurement and data processing:

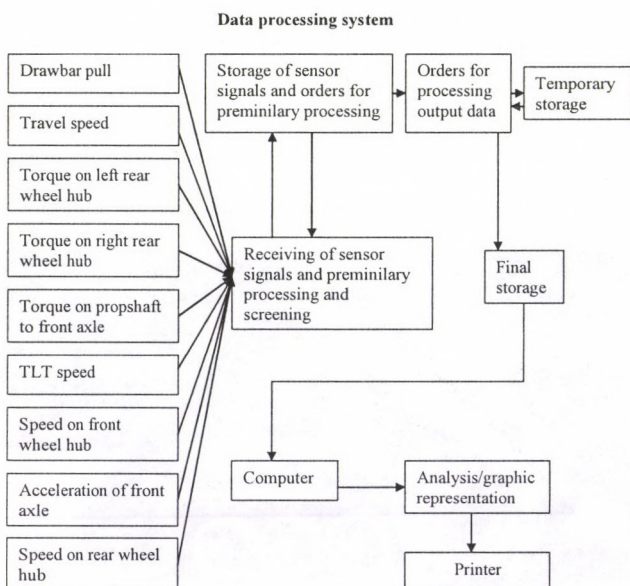

Drawbar test:

- The drawbar pull load was increased at nearly uniform degrees until the slip of wheels got to 25 %
- In each testing series, 25 to 30 measuring points
- At each set of drawbar pull load 10 s measuring time and 400 Hz sampling frequency
- Rear differential lock switched on
- Constant total weight
- Zero point of wheel slip - the tractor speed, when the tractor travels without drawbar load and at 642 min⁻¹ PTO speed at the given setting and operating system in four wheel drive.
- Field: clayey-loam covered whit wheat stubble
- Asphalt road (self traction test)

Characteristics determined from the registered data:

- Wheel slip (%)
- Drawbar power (kW)

- Power on the drive shaft to front axle (kW)
- Power on rear wheel hubs (kW)
- Traction efficiency (%)
- Dynamic front axle load (N)
- Dynamic rear axle load (N)
- Traction coefficient (N/N)
- Rear vs. front ratio of wheel power (kW/kW)
- Gross traction ratio (N/N)
- Net traction ratio (N/N)

Test results

Self traction power requirement of the tractor:

At all the three driving system in the investigated axle load and travel speed range:

- The self traction power requirement is decreasing with the growing of the static front axle load,
- The self traction power requirement is increasing with growing the travel speed.

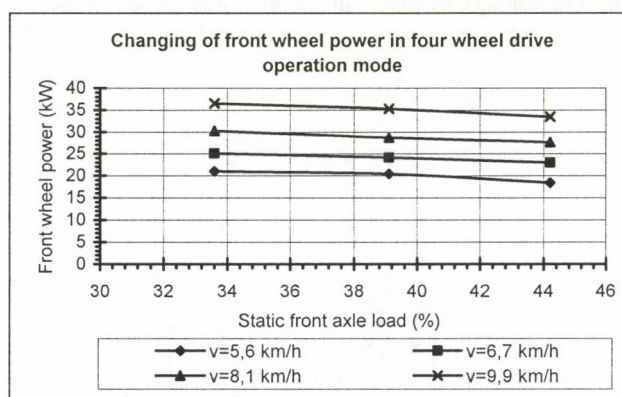

Figure 1

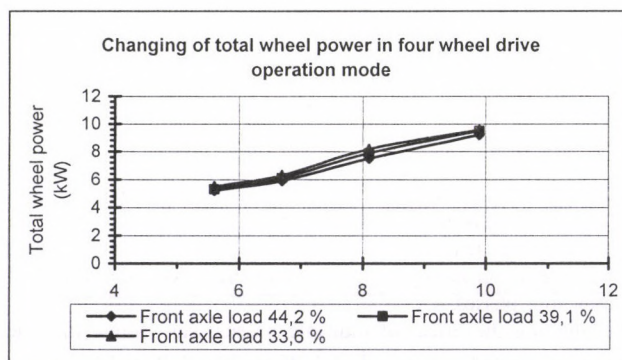

Figure 2

Wheel slip in self traction operation mode of the tractor

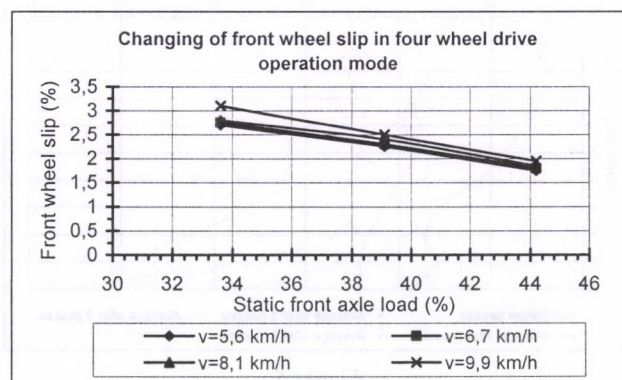

Figure 3

The front wheel advance at different static front axle load:

Static front axle load
 44,2 %
 39,1 %
 33,6 %

Front wheel advance
 3,0 %
 3,4 %
 3,8 %

The partially processed data of the drawbar test:

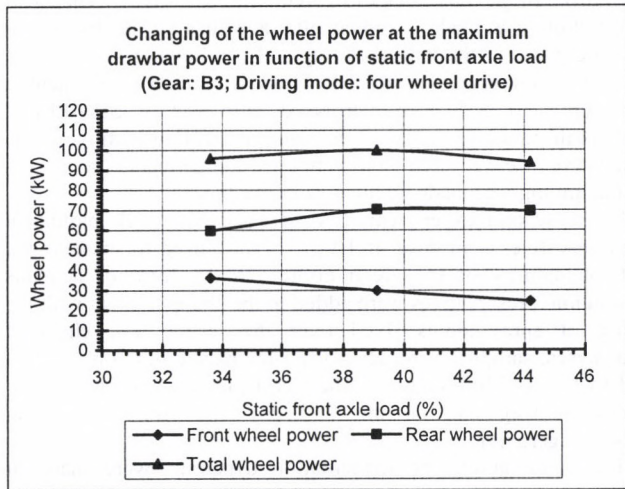

Figure 4

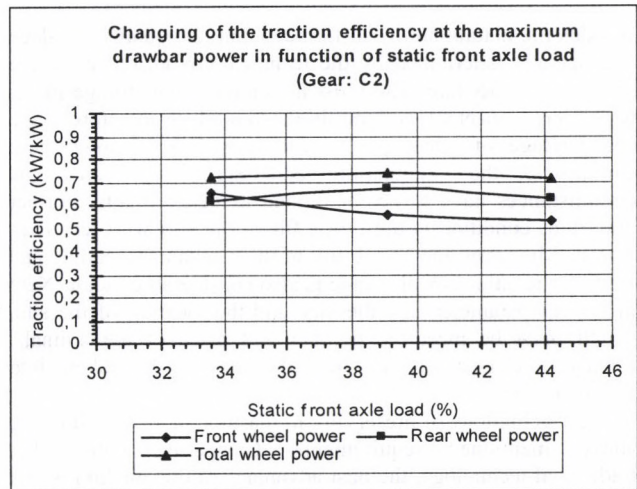

Figure 5

EFFECT OF BIOLOGICAL PRESERVATIVES ON THE QUALITY OF SILAGE PRESERVED IN PLASTIC TUBE (OTKA T 030031)

Z. Bellus¹ – J. Csermely¹ – J. Schmidt²

¹Hungarian Institute of Agricultural Engineering, Gödöllő

²University of West Hungary, Mosonmagyaróvár

Introduction

Besides the natural ability to fermentation, the quality of silage is especially determined by the technical circumstances of the preserving procedure. The most important is the storage place, which has to meet a lot of conditions to produce and store silage and haylage of good quality with low loss. Among these conditions, the stimulation and sustain of anaerobic circumstances have to be mentioned as determinants. Further important condition is the quick fill of the silo with less live-labour. Moreover, the possibility of the mechanical loading and feeding the animals with silage is also considerable factor. Next important parameters are the size and the location of the silo, which must be meet the number and place of the animals. Finally, the cost of the silo also has to be taken into consideration.

In fact, technology of preserving in plastic tube meets all of the above mentioned requirements. Comparing with other traditional technology, the best advantage of this method is that the anaerobic circumstances, – which highly determine the success of ensilage – can be produced faster, more perfectly and can be kept permanently. Although this technology can be used with good results in the fermentation of many forage, its advantages can be utilised mostly in the preserving of silage plant with low fermentability (e.g. alfalfa).

Nevertheless, the method improves the conditions of the fermentation, but it has no effect on the natural fermentability of the silage crop. In consequence, with this technology, stable silage can be produced from alfalfa with low fermentability just in case if this natural fermentability is improved in any way.

The application of wilting or any additives, or combination of them, are the suitable procedures to reach the above-mentioned purpose. In the case of this technology, wilting is necessary not only for the improvement of the fermentability. It is also important because the intensive compression produces effluent from the chopped alfalfa with less than 30 % dry matter content during the ensilage. The effluent is harmful to the fermentation of the green plant in the bottom of the plastic tube and it causes environmental pollution too.

In the case of plastic tubes, due to the intensive compression, the maximum dry matter content can be higher, than 37-38 % content, which is recommended for other horizontal silos. The maximum can reach even the 43-45 % dry matter content. If the dry matter content is higher, the compression efficiency decreases during the ensiling, which is indicated by the reducing mass per volume.

In the case of high dry matter content, the nutrient losses increase in the storage yard caused by the respiration. Furthermore, the field losses are higher in consequence of the longer wilting, since the mechanical losses, the leaf-loss and the risk of the weather conditions also increase during the longer wilting on the field. These disadvantages can be avoided if the natural fermentability of the green alfalfa is increased by the use of additives, because in this case there is possibility to ensile green plant with lower dry matter content.

Taking the above mentioned facts into consideration, during the experiment the authors examined the effects of different additives on the quality of the alfalfa silage ensiled in plastic tube. The authors investigated the effects of the second- and third - generation biological preservatives avoiding the human and animal health hazard of the chemicals.

Material and method

The field tests based on the technology of preserving in plastic tube were executed in the farm of the Agricultural Co. of Dalmand in Közéhidvég and in the farm of Agroprodukt Co. in Marcalgergelyi. TAUROS T-40 and BAGGER G-7000 type machines were used. In the first experiment, the dry matter content of alfalfa was between 32,2-34,1 % in the case of both control silage and silage treated with additives. The next variation was made of green alfalfa with 45,4 % dry matter content due to the longer wilting and windrowing on the field. 10 % corn grit + PIONEER 1188 lyophilised lactobacteria culture and 5 % pre-hydrolysed corn grit + SILAFERM lyophilised starter culture were used as ensiling additives. The additives were layered on the chopped forage inside the wagon, and mixing was made by the ensiler machine.

In the second experiment, LALSIL and SIL ALL biological preservatives – in dose of 10 g t⁻¹ – were used to increase the fermentability of the green alfalfa. In the form of aqueous solution, preservatives were added to the chopped plant with the use of spray-booms fixed over the feeder. For chemical analyses, samples were taken from the plastic tube on the 20th, 120th and 270th days of the fermentation and storage in Közéhidvég and on the 96th day after the ensilage in Marcalgergelyi.

The examinations of fermentation dynamics were made at University of West Hungary (Department of Animal Nutrition, Faculty of Agricultural Sciences). The fermentation was executed in model silos with the capacity of 1 litre. 5-5 silos of each treatment were decomposed on the 7th, 15th, 30th and 60th test days. During model-tests the authors examined the effects of LALSIL and SIL ALL preservatives on the fermentation.

The chemical contents of the green alfalfa and silage were determined according to the Hungarian Feed Codex (Chapter 5.1, 6.1., 7.1., 8.1. and 10.1.). Lactic acid and volatile fatty acid content of the silage samples were measured with Chrom-5 gas-chromatograph (resin filler: Supelco Carbopack B-DA). NH₃ content was determined with ammonia-receptive electrode (Radelkisz OP 242-2).

Results

The data showing the quality of silage made with carbohydrates and lactic acid bacteria inoculation, are in Table 1. It can be seen, that the quality of the silage was definitely improved by the use of these additives. The beneficial effect of the carbohydrates additive was demonstrative not only in the early stage of fermentation, but during the whole fermentation process and storage, even on the 270th day of the storage. Due to the fermentable carbohydrates increased by additives, the treated silage contained more lactic acid, than the variations, which were only made of wilted material without any additives. The improving effect of pre-hydrolysed maize additive was higher, than of normal maize, because the reductive sugar content of the pre-hydrolysed maize is significantly higher (355 g kg⁻¹), than the fermentable carbohydrates content of the normal maize (3.2 g kg⁻¹). Silage made from alfalfa with higher dry matter content, had the least lactic acid concentration, because the water activity is disadvantageous to the bacteria producing lactic acid at 45% dry matter content.

After the 120th day, the lactic acid content of the silage decreased as a result of the secondary fermentation processes in all treatments. Compared the states on the 120th day, the rate of this reduction was the highest (16,2 %) in the control silage , and it was the least (4,4 %) in the silage with pre-hydrolysed maize additive. In the case of normal maize additive, the reduction of the lactic acid content was 9,5 % between the 120th and 270th days. The lactic acid content of the silage made of alfalfa with high dry matter content, decreased with 9,1 %.

Table 1. The quality of the alfalfa silage ensiled into plastic tube

Treatment	pH			Lactic acid, %			Acetic acid, %			NH ₃ mg/100 g		
	20.	120.	270.	20.	120.	270.	20.	120.	270.	20.	120.	270.
	day			day			day			day		
1.	4.20	4.38	4.51	2.06	2.72	2.28	0.53	0.61	0.82	51.11	117.88	115.80
2.	4.05	4.36	4.36	2.25	2.83	2.56	0.52	0.68	0.69	58.63	102.89	118.70
3.	3.97	4.30	4.07	2.47	3.26	3.05	0.51	0.52	0.53	35.56	96.79	90.80
4.	4.50	4.86	4.90	1.63	2.53	2.30	0.63	0.44	0.47	38.23	125.04	136.46

1. treatment: Shorter wilting

Dry matter content: 34,12 %

2. treatment: Shorter wilting + 10 % corn grit + Pioneer 1188 additive

Dry matter content: 32,58 %

3. treatment: Shorter wilting + 5 % pre-hydrolysed maize + Silaferm additive

Dry matter content: 32,17 %

4. treatment: Longer wilting

Dry matter content: 45,43 %

Opposite of the lactic acid content, the acetic acid content gradually increased during the fermentation and storage. The acetic acid content was the least in forages with high dry matter content due to the low water activity of the alfalfa (similarly to the case of decreased lactic acid content).

The lactic acid ration and acetic acid ration (% of total organic acid), which influences the nutritive value and palatability of the silage were beneficial in the case of each tested variations. In samples taken on the 270th day of the silage, the acetic acid proportion in total organic acid content was as follows: 1st treatment: 26.4 %; 2nd treatment: 21.2 %; 3rd treatment: 14.8 %; 4th treatment: 17.0 %. The proportion was the best in silage ensiled with pre-hydrolysed maize additive and in silage made of alfalfa with high dry matter content. However this proportion is acceptable if the proportion of acetic acid is under 30 %. The use of pre-hydrolysed maize additive and the inoculation with lactic acid bacteria had beneficial effect also on the NH₃ content of the silage. The lowest ammonia concentration was measured in the silage produced with this treatment on each sampling day. This result shows that this treatment resulted in the lowest protein-loss. (Figure 1.)

Results, regarding the quality of silage made with third-generation biological preservatives are summarised in Table 2.

Table 2. The effect of biological preservatives on the quality of wilted alfalfa silage preserved in plastic tube

Treatment	pH	Lactic acid	Acetic acid	Propionic acid	NH ₃ mg/100g
		% (in silage with the original dry matter content)			
Control	4.42	2.66	1.33	0.02	107.92
LALSIL	4.38	2.76	0.92	n.d.*	83.55
SIL ALL	4.40	2.70	0.64	0.01	94.80

* not detectable

The authors have found that both of the examined preservatives improved the quality of the silages, because the preservatives had beneficial effect on reduction of acetic acid and NH₃ content. LALSIL additive decreased the acetic acid content of the silage by 30.8 %, while SIL ALL additive reduced it by 29.3 %. Due to this fact, the proportion of acetic acid to other acids became more beneficial (CONTROL: 33.3 %; LALSIL: 25.0 %; SIL-LALL: 25.8 %). The lower acetic acid content of silage can be explained by the inoculated homofermentative lactic acid bacteria culture. This culture promoted a faster proliferation of lactic acid producing bacteria to become dominating flora in early stage of fermentation. In consequence, it helped the early inhibition of bacteria producing acetic acid – firstly bacteria belonging to coli aerogenes group – through competitive inhibition. Due to the lower acetic acid content, the

fermentation losses decreases. Further advantage is that the animals consume more of this treated silage.

As a result of the biological preservatives added to silage, the NH₃ content decreased relatively by 22.6 % in the case of LALSIL, and by 12.1 % using SIL ALL comparing with the control silage. This was beneficial, because the NH₃ content reduction was caused by the lower protein degradation. Contrary to expectations, biological preservatives – containing cell wall breaking enzyme – increased the lactic acid content of the silage just in a small rate. Presumably, the tested preservatives did not contain enough cell wall degrading enzyme, or the difference – measured until the open of the silo – between the control and treated silage can be neglectable as a result of the secondary fermentation processes. Although, the lactic acid content of the silage treated with biological preservatives was higher in the early stage of fermentation.

To confirmation the above mentioned assumptions, a fermentation dynamics test was executed with preservatives examined previously in the field experiment. The results of this test are shown in Table 3. During the whole fermentation process, according to the results, quality of the silage treated with biological preservatives was higher compared to the control silage. This statement is admitted by the higher lactic acid content, the lower acetic acid content – more beneficial proportion of lactic acid to acetic acid –, and the lower pH of the investigated silage. Besides this, the stability of the tested silage was better, than of the control silage. It was confirmed by the lower propionic acid content of the treated silage. As the effect of biological preservatives, the silage did not contain any butyric acid even on the 120th day after the ensilage.

The effect of SIL ALL on quality of the silage was slightly better than the effect of the other biological preservatives. The authors have found in lab-examination, that the difference between the quality of the silage treated with biological preservatives and the control silage was slightly higher, than the difference measured in field test. As an explanation, the dry matter content of the green alfalfa was lower during the fermentation dynamic experiment, than in field test. The lower dry matter content was more beneficial to the operation of cell wall degrading enzymes (Figure 2.).

In the same time, in the case of silage treated with biological preservatives, there were no considerable difference in quality between samples taken in the first 15th days of the fermentation (the primary period of the fermentation) and after the end of fermentation (80-120th days). During model tests, the quality of the silage treated with biological preservatives was higher compared to control silage. However, the difference was lower, than expected. The authors concluded that the increase of concentration of the examined enzymes or the use of further enzymes are necessary.

Table 3. The effect of biological preservatives on the fermentation dynamics of the green alfalfa (dry matter content of the green alfalfa: 30.0 %)

Treatment	Fermentation day	pH	% in silage				NH ₃ -N mg/100g
			Lactic acid	Acetic acid	Propionic acid	i-Ethyl acetic acid	
Control	7.	5.67	0.99	1.00	-	-	41.46
	15.	5.52	0.96	1.21	0.03	-	76.05
	30.	5.49	0.90	1.28	0.06	-	87.67
	60.	5.44	0.80	1.31	0.17	0.01	121.01
	120.	5.53	0.74	2.34	0.26	0.07	181.30
LALSIL	7.	5.23	1.13	0.77	0.02	-	88.13
	15.	5.25	1.05	1.11	0.02	-	69.90
	30.	5.33	0.88	1.05	0.04	-	100.36
	60.	5.33	0.88	1.34	0.06	-	112.12
	120.	5.42	0.95	2.06	0.22	-	153.63
SIL ALL	7.	5.30	1.06	0.81	0.02	-	56.26
	15.	5.32	1.00	1.03	0.02	-	78.04
	30.	5.31	0.92	1.11	0.03	-	83.17
	60.	5.28	0.86	1.20	0.06	-	131.84
	120.	5.24	0.99	2.24	0.08	-	140.50

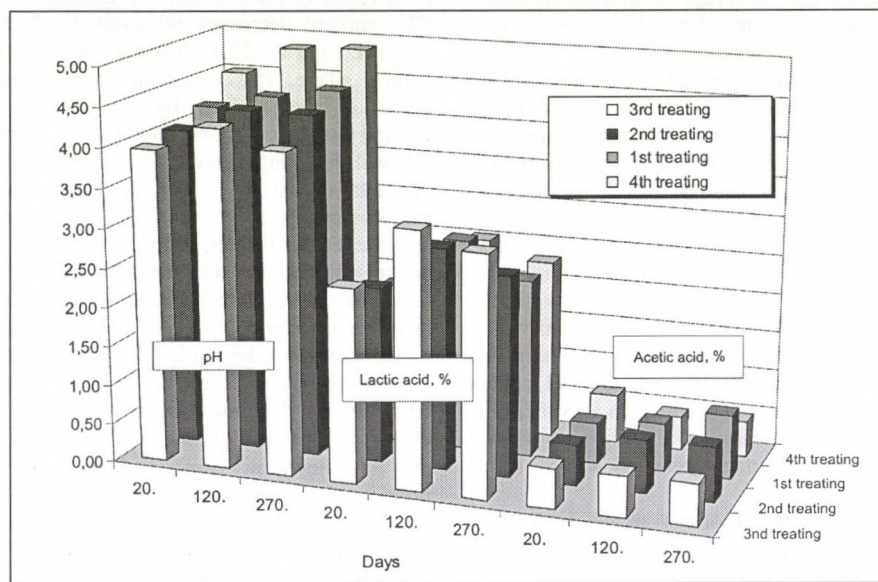

Figure 1
Fermentative process of alfalfa silage

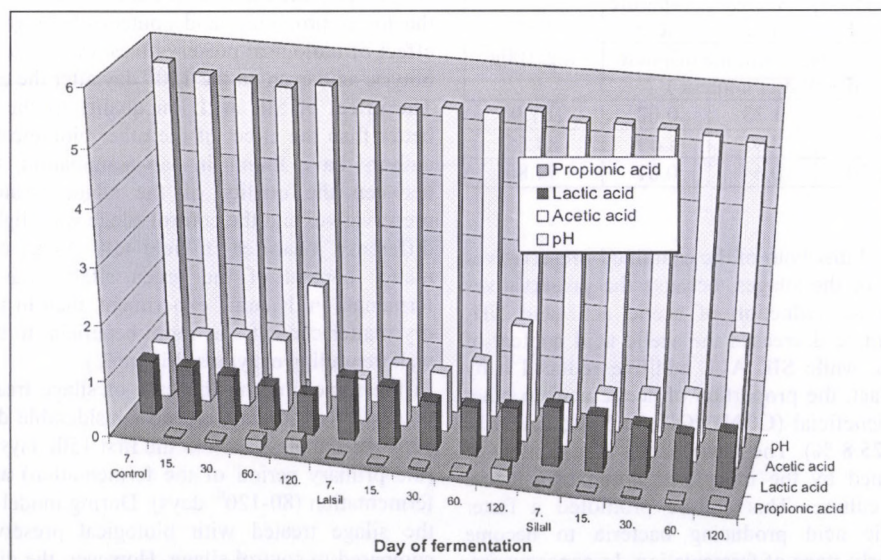

Figure 2
The effect of biological additives on fermentation process in alfalfa silage

THE DEVELOPMENT OF DRYING TECHNOLOGIES

M. Herdovics

Hungarian Institute of Agricultural Engineering, Gödöllő

Corn is the decisive fodder plant in Hungarian agriculture, primarily used as cereal.

The technology of post-harvest processing, whose most important elements are seed drying and storage are closely connected to the technology of producing corn.

Corn is grown on 1.2-1.3 million hectares in Hungary. The content of moisture at harvest time is 22-25 %.

Given the Hungarian climatic conditions, the grain – apart from a few exceptional years and one or two special species – must be dried.

The cost of drying might be decisive from the point of view of the efficiency of production. Its extent – depending on the content of moisture, the species and the applied technology of drying (performance, energetic features and utilization) – may reach 25-40 % of the full production cost.

The cost of drying is fundamentally influenced by the content of moisture of the grain, other parameters of the drying technology and the speed of moisture loss, etc.

The content of moisture of the grain to be dried is fundamentally determined by the following:

- species
 - duration of growing (FAO number)
 - the ripening dynamics of the hybrids (speed of moisture loss)
- technology of production
 - time of sowing
 - nutrient supply, etc.
- weather
 - climatic features (precipitation, etc.)
- time of harvest

In identical conditions, the quantity of harvested crops is also interrelated with the features mentioned above.

Generally, but not principally, in the case of hybrids, the duration of growing is in interrelation with the crops yield.

Species with longer duration of growing usually result in higher crops yield, however this is accompanied by higher content of moisture.

The optimisation of the utilization of the agro ecological potential is best realised in such a way, that the producer achieves the maximum possible result.

In the autumn period of harvesting the cereals the Hungarian drying plants also have to dry the seed of the oil plants (sunflower, rape).

The present condition of the fleet of grain driers

Unfortunately, the present Hungarian fleet of grain driers still consists of overwhelmingly (75-80 %) outdated equipment

(typically, SIROKKÓ 30/4, etc.), most of the plants were built in the 70's and 80's.

Following the economical transformation of the past decade, the new investments into grain driers were made typically by smaller and medium sized farms, thus the investments were made to cater for their needs. The proportion of modern drying plants is approximately 40 %.

In recent years several modern drying plants have been set up, however, the establishment of 20-30 new plants is not sufficient to renew the outdated fleet of machinery.

The industrial and technological needs demanded new priorities from new investments at this time.

The demands regarding technology are the following:

- ability to fulfill a wide range of demands regarding performance (private farm, medium-sized enterprise, cooperation, large servicing plant)
- favourable investment costs (loan or possibility for payment in parts, company loan)
- favourable energy consumption, low operating costs
- wide range of technological versions
- moisture regulation

When setting up new plants, it is especially important to meet the requirements regarding the protection of environment – without this it is not possible to set up a drying plant.

As for the developments of the driers, the following trends are in focus:

- **Traditional or developed pit system driers with recirculation.** (Figure 1: CIMBRIA BED 16R) (CIMBRIA, STELA, PETKUS) (Western European trend of development)

Users: large plants, medium sized plants

Output: * 10-15 ton/hour

- **Tower cylinder driers** (Figure 2: MEYER drier) (MEYER, GSI), (American-Italian trend of development)

Users: large plants, servicing plants

Output: 15-20 ton/hour

- **Batch driers** (Figure 3: GSI-Competitor 119 drier)
-Driers with material circulation or cascade system (MECMAR, GSI)

Users: medium sized plants, family farms

Output: 2-5 ton/hour

*Remark: * drying from 25 % to 14 %*

The thermal energy consumption of the new, energy saving driers is 30-35 % better than that of the traditional driers with cross-flow (B1-15).

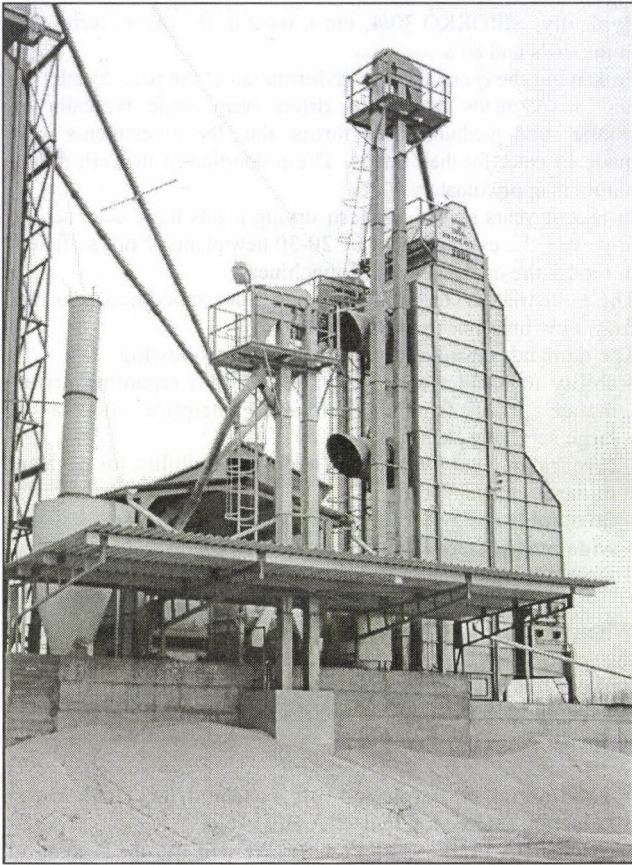

Figure 1

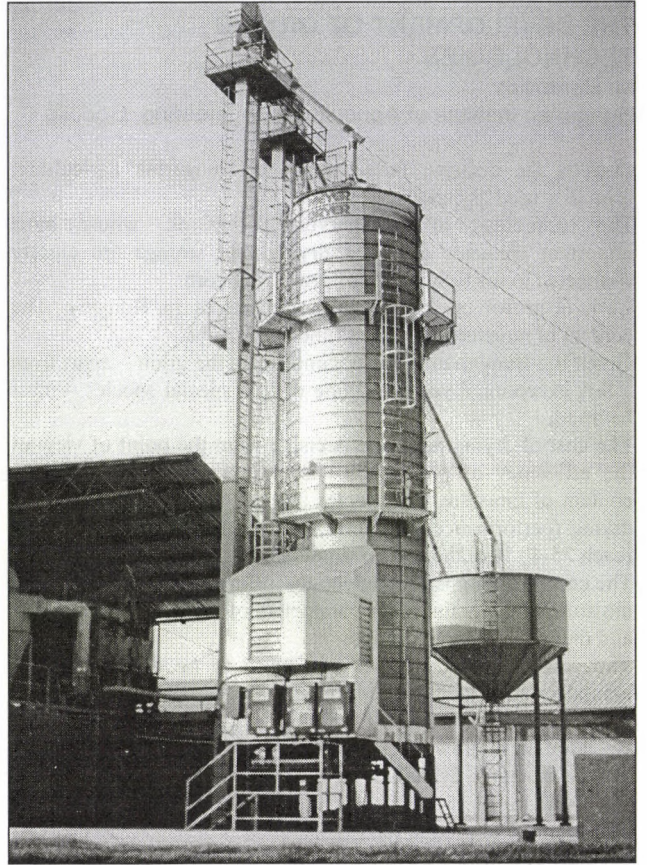

Figure 2

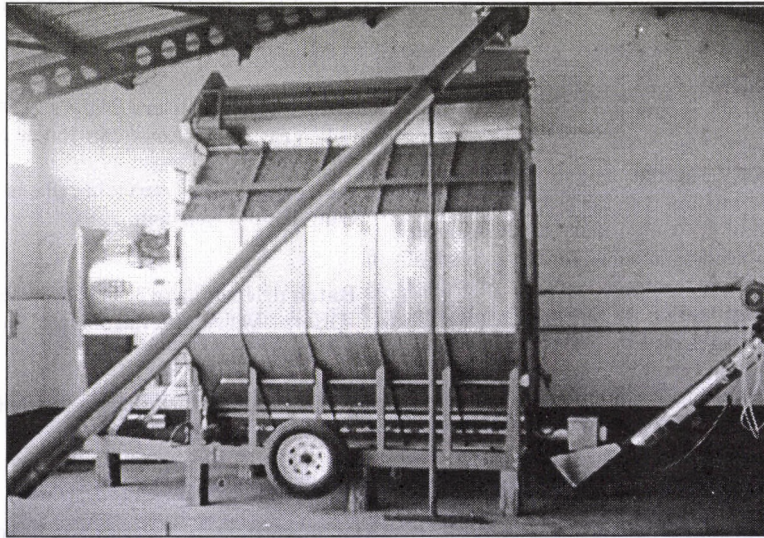

Figure 3

COMPARISON OF BALE WRAPPING MACHINES

Z. Bellus

Hungarian Institute of Agricultural Engineering, Gödöllő

Introduction

In the last years, as a result of the improvement in the quality of the agricultural production and farming, special machines developed for ensilage in Western European practice, appeared in Hungary.

The nutrient content and fermentation characteristics of fermented forage are important parameters in feeding of ruminants, as the demand of animals must be continuously cover both in winter (dairy cows and heifers) and in summer (beef).

The authors compared the bale wrapping methods of forage with low and high moisture content among technologies, based on the packing and pressing methods, which are regarded as the most modern preserving-storing technologies for forage at present. These up-to-date technologies give new aspects the feedstuff management and supply.

Material and method

In connection with the research, the evaluation of machines with different constructions based on the comparison of technical, technological, energetic and operating features (characteristics of material, weight of bales, base and productive times, utilisation factors and performance, fuel consumption, specific energy consumption and plastic film demand, etc.) measured during the preserving and storage of forage between 1998 and 2002 concerning alfalfa and grass, was completed in nine farms.

Results

The bale wrapping technology, developed to reduce or eliminate some losses of fermentative preservation of forage, and related proper field technology (plastic cylinder for stalk crush, rotary mower, windrower, variable chamber baler with cutting system) provide the high quality. Furthermore, the use of additives, promoting fermentation during the bale wrapping is appropriate for producing high quality end-product. The field technology, the bale wrapping technique and usage of additives have substantial advantages in quality, due to the perfect anaerobic circumstances compared to the traditional, stack-storing, plastic covering technologies.

Bale wrapping machines with hydraulic motor-system can be divided into two main groups according to their driving: it is provided by a separated engine (hanging or towed constructions) or by the own engine (petrol- and diesel engine automotive constructions).

The first group of wrapping machines for single bales move in a complex three-dimensional way - which is essential for the covering of the bale - with the help of the bench and/or the bale-moving cylinders of the bench (in some cases with belts) and/or roller-prestresser mechanism (e.g. TELLEFSDAL AW-1200 EH, WOLVO-WOLAGRI FW-15 WELGER FG-15 etc.). Some of the above mentioned machines are self-servicing (e.g. M-1610, SUPERTINO ABS 15 S, GEMELLI 120/3 SPI, PÖTTINGER G 90S).

Simple constructions are exceptions, where the role of the work-bench is transferred to the field, while the rolling is traditional (e.g. PITOCCHI BRTP)

The second part is the group of the bale wrapping machines with group system. As it comes from their name, these machines produce 'bale-sausages' fitting them tangentially and continuously. It is the result of the multiple-thread covering operation (it uses more rolls of plastic film at the same time), which is accomplished with the proper pitch on the lateral area of the sausage. Besides the examinations concerning rolled bales, the authors mention the universal bale wrapping machines as a further possibility. These machines are developed for covering the units of squared bale stacks.

Some of the machines presented, as the WOLVO-WOLAGRI FW-15, the WELGER FG-15, PÖTTINGER ROLLPROFI 90 SG, the SUPERTINO ABS 15S and the GEMELLI 120/3 SPI can pick up the bales on their own, while other machines (e.g. PITOCCHI BRTP) accomplish this operation specially with the constant holding of the bales on the working-bench (on the field) or with the collective operation of the baling and wrapping in the case of the RECO R-52 + AUTO WRAPPA machine group.

Service of other machines working in either single or group system (e.g. SILAWRAP UN 7556, KP-646, EBKO, COMBI PACK) depends on the management of the loaders and the optimal placing of the bales before wrapping, which is necessary for bale-loading.

Technical and technological parameters of bale wrapping machines with different constructions concerning bale wrapping and covering of rolled bales, and the characteristic of the material measured during the wrapping, moreover the relation between the performance and specific energetic parameters of the baling process are demonstrated in Figure 1 and they are summarised in Table 1 and 2.

Development program

The most spectacular improvement was in the development of single-system bale wrapping machines. In this field, the most important steps were the execution of self-service, the multiple-rolling mechanism, which is necessary for higher performance, and in the same time the introduction of the multiple-thread rolling method, the total automatization of the wrapping process and the remote control from the driver engine.

The further increase of the performance was carried out by the decrease of the secondary time necessary for serving, and - as a result of this - by the construction of the machine group and the procedure of „single-run” baling-wrapping. In the first step, the development of the simpler wrapping machines, which followed the baler in a controlled way and were applied to cover the rolled bales, started. This progress was followed by the development of a single-or double axle special structure, which contained both the baler and the wrapping machines. Due to its universality, this structure included the wrapping machine, which was necessary for wrapping both the rolled and the square bales (Figure 2).

Next and present step of the development is the construction, where the baling and wrapping is carried out in the same machine, in the baler. During the operation of the baler the bale does not leave the chamber responsible for forming, pressing and rolling before the final step ('end-product') (Figure 3).

In connection with developments, we have to mention the structure of the special loader-adapter, which necessary to holding and moving the wrapped bales. The development and production started in this field would make the agricultural machines market (hanging and towed equipment, service requiring systems, production and distribution of proper wrapping material) complete in Hungary.

Table 1 performance parameters of bale wrapping machines

Type	Winding turn (rpm)	Base time (h)	Productive time (h)	Base time efficiency (th ⁻¹)	Productive time efficiency (th ⁻¹)	Productive time utilisation index (%)
TELLEFSDAL AW-1200 EH						
K 130S HI	24	0.042	0.050	11.5	9.7	84.0
K 130S HII	36	0.550	0.065	8.9	7.5	84.6
WOLVO FW-15						
W R012 HI	18	0.016	0.041	30.8	11.8	38.3
R 12 HII	24	0.021	0.047	24.0	10.5	43.9
KVERNELAND UN 7556						
CR 250 SZ	24	0.024	0.0504	35.1	16.4	46.2
KP-646						
DF MP122 SZI	24	0.029	0.034	20.3	17.4	85.6
DF MP122 SZII	36	0.038	0.045	14.0	11.9	85.7
WELGER FG-15						
W R12 HI	24	0.029	0.035	14.6	12.3	82.9
W R12 SZII	36	0.037	0.044	10.6	8.9	84.1
PÖTTINGER RP G 90S						
P RP3500 HI	24	0.021	0.045	26.7	12.5	47.1
P RP3500 SZII	36	0.033	0.058	18.9	10.7	56.6
SUPERTINO ABS 15 S						
CR 250 H	30	0.021	0.025	9.1	7.7	45.7
M-1610						
JD 575 H	24	0.032	0.058	14.4	7.9	55.2
GEMELLI 120/3 SPI						
R12 SZI	12	0.012	0.025	42.8	20.6	48.0
R12 SZII	18	0.018	0.031	30.8	17.4	56.4
PITOCCHI BRTP						
130S HI	24	0.023	0.043	16.1	8.6	53.5
130S HII	30	0.027	0.049	14.7	8.1	55.1
EBKO WRAP LINER MT-26						
1300 HI	11	0.007	0.027	30.2	7.8	25.9
R46 HII	11	0.005	0.012	75.2	30.1	40.0
POMI KOMBI PACK						
3500 HA	10	0.022	0.059	46.1	17.1	37.1
3500 HII	12	0.070	0.064	33.5	14.7	43.7
RECO R-52 + AUTO WRAPPA						
	24	0.019	0.025	20.1	15.8	76.0

Table 2 Energetic parameters of bale wrapping machines

Type	Winding turn (rpm.)	Weight of bale (kg)	Fuel consumption		Specific- energy consumption	
			(kg h ⁻¹)	(kg t ⁻¹)	(MJ h ⁻¹)	(MJ t ⁻¹)
TELLEFSDAL AW-1200 EH						
130S HI	24	487.0	3.88	0.34	162.5	14.2
130S SZII	36	490.0	4.16	0.47	174.2	19.7
WOLVO FW-15						
R12 HI	18	477.0	7.62	0.25	319.0	10.4
R12 HII	24	497.5	8.89	0.37	372.2	15.5
KVERNELAND UN 7556						
R 250 SZ	24	825.5	2.27	0.06	95.0	2.7
KP-646						
F MP122 SZI	24	582.5	2.44	0.12	102.2	5.1
F MP122 SZII	36	536.5	2.47	0.19	103.4	8.0
WELGER FG-15						
R12 HI	24	393.0	7.24	0.49	303.1	20.5
R12 SZII	36	430.0	8.95	0.84	374.7	35.2
PÖTTINGER RP G 90S						
RP3500 HI	24	564.5	6.24	0.23	261.3	9.8
RP3500 SZII	36	625.0	7.30	0.38	303.9	16.1
SUPERTINO ABS 15 S						
R 250 H	30	192.0	1.86	0.20	77.9	8.4
M-1610						
D 575 H	24	460.0	4.62	0.32	193.4	13.5
GEMELLI						
R12 SZI	12	522.0	7.84	0.18	328.3	7.7
R12 SZII	18	545.5	9.8	0.32	408.6	13.3
PITOCCHI BRTP						
130S HI	24	365.0	2.57	0.14	107.6	5.9
130S HII	30	402.0	2.60	0.17	99.2	7.1
EBKO WRAP LINER MT-26						
1300 HI	11	517.5	1.06	0.04	44.2	1.5
R46 HII	11	710.0	1.99	0.03	83.3	1.1
POMI KOMBI PACK						
RP3500 HA	10	1024.0	2.35	0.05	98.4	2.1
RP3500 HII	12	941.0	2.38	0.07	99.7	3.0
RECO R-52 + AUTO WRAPPA	24	394.0	2.74	0.14	114.7	5.7

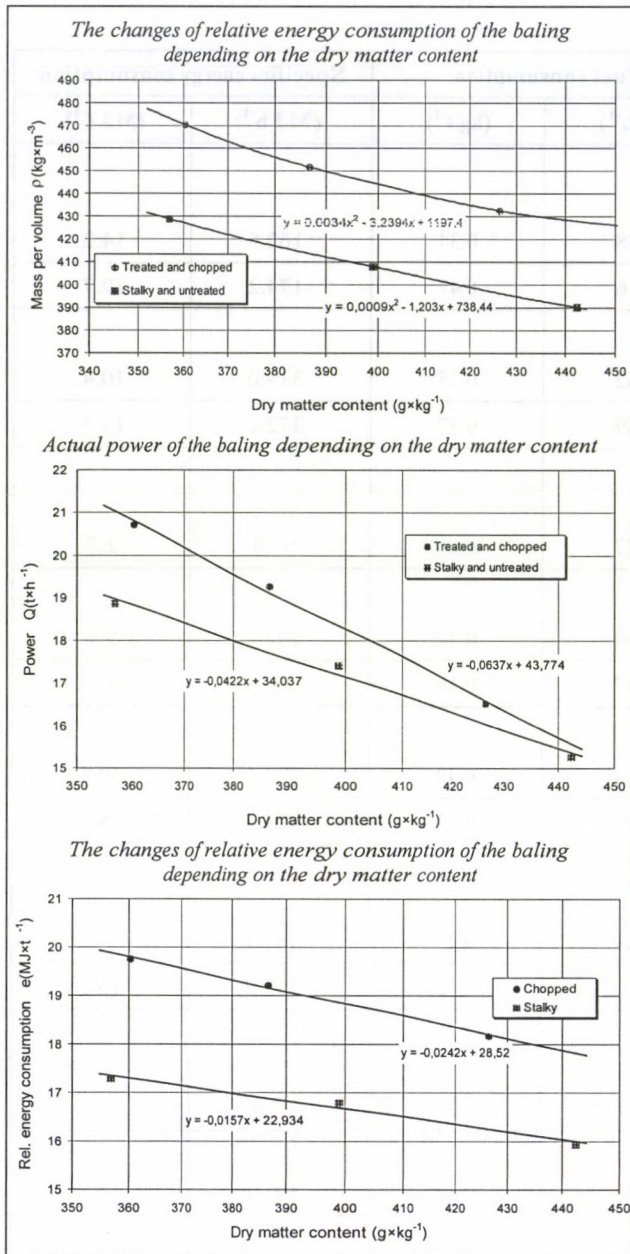

Figure 1



Figure 2
Vicon Bale Pack



Figure 3
Taarup Bio

Apart from the fact, that wrapping machines with low-, middle-, and high-performance can meet the requirements of farms with different sizes, they are absolutely suitable practical machines for rent. From these machines those, which use multiple wrapping technique can be operated economically in large-scale farms with high number of animals, while machines with low-efficiency and single-system can be suitable in family- and small farms.

ON DETERMINATION OF THE HEAT CONDUCTIVITY OF CEREALS AND AGRICULTURAL GRIST MATERIALS

E. Judák – G. Kovács – L. Fogarasi – P. Korzenszky
Szent István University, Gödöllő

Introduction

The properties of the agricultural materials are basically important in the food industry and the design processes of the food-industrial devices. Unfortunately, regarding the professional literature sources, the available data base of some material properties (as the values of dielectric constant, thermal conductivity or specific heat etc.) is not really perfect at all. An instrument is presented in this paper, which is used for measuring the thermal conductivity values of different materials. The determination of the thermal conductivity coefficient with the help of the instrument is carried out on the base of stationary measuring method. The unknown material property is measured in the way of its comparison to the thermal conductivity value of the standard material chosen (reference). Using this relative method, many data of the instrument parameters can be eliminated and the measuring accuracy may be increased in this way. Of course, the standard material must be chosen from those materials of which thermal conductivity coefficient values are available with high accuracy in the literature. Another important point of view in the selection of the standard material is that its reference value of thermal conductivity coefficient should be of the same order of the unknown thermal conductivity coefficient value to be determined. In this way, the intermediate temperature to be measured can be set close to the arithmetic mean value of the inlet and outlet surface temperatures and the measurement accuracy may be improved. The function between the temperature and the bulk density of the material to be measured must be recorded in the case of each substance separately. The used standard of cork was chosen because of the tested material (wheat) and its 10 cm thick grain layer. The data determined by measuring the thermal conductivity coefficient can be used for quality classification of materials, too, amongst other purposes.

The principle of the measurement of the thermal conductivity factor

The conduction of heat is originated from the Brown's heat-moving and interferes of particles induced by the temperature-

difference and the heat (energy) flows from the warmer place to the colder place. Supposing a heat flow density as the constant and one-way flux trough a homogeneous space, the following relationship can be written down (Fourier's law):

$$q = \frac{dQ}{A \cdot dt} = \lambda \frac{dT}{dl}$$

where q is the heat flow density, λ is the thermal conductivity factor of the sample, dT/dl is the temperature gradient (the differential quotient by the path length of heat transfer) and dQ/dt is the heat flow (heat power) through the surface area A .

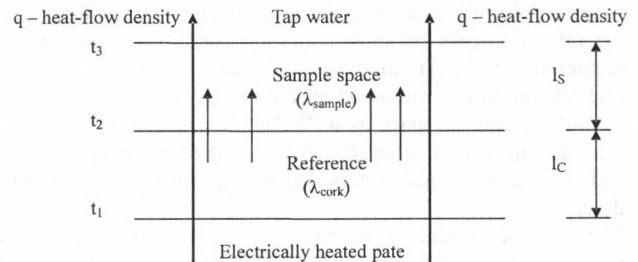

The known quantities are the thermal conductivity factor of the cork etalon (λ_c) and the values of the layer thickness (l_s and l_c) and the values of temperature (t_1 , t_2 and t_3) can be considered as known with the help of the testing card.

$$q = \frac{dQ_p}{A \cdot dt} = -\lambda_c \cdot \frac{t_1 - t_2}{l_c} = -\lambda_s \cdot \frac{t_2 - t_3}{l_s}$$

Supposing the constant heat-flow density, the unknown thermal conductivity factor (λ_{sample}) can be formed as an explicit variable:

$$\lambda_s = \lambda_c \cdot \frac{l_s \cdot (t_1 - t_2)}{l_c \cdot (t_2 - t_3)}$$

The assembly sketch of the instrument developed for measuring the thermal conductivity factor related to the bulk material can be seen in Figure 1.

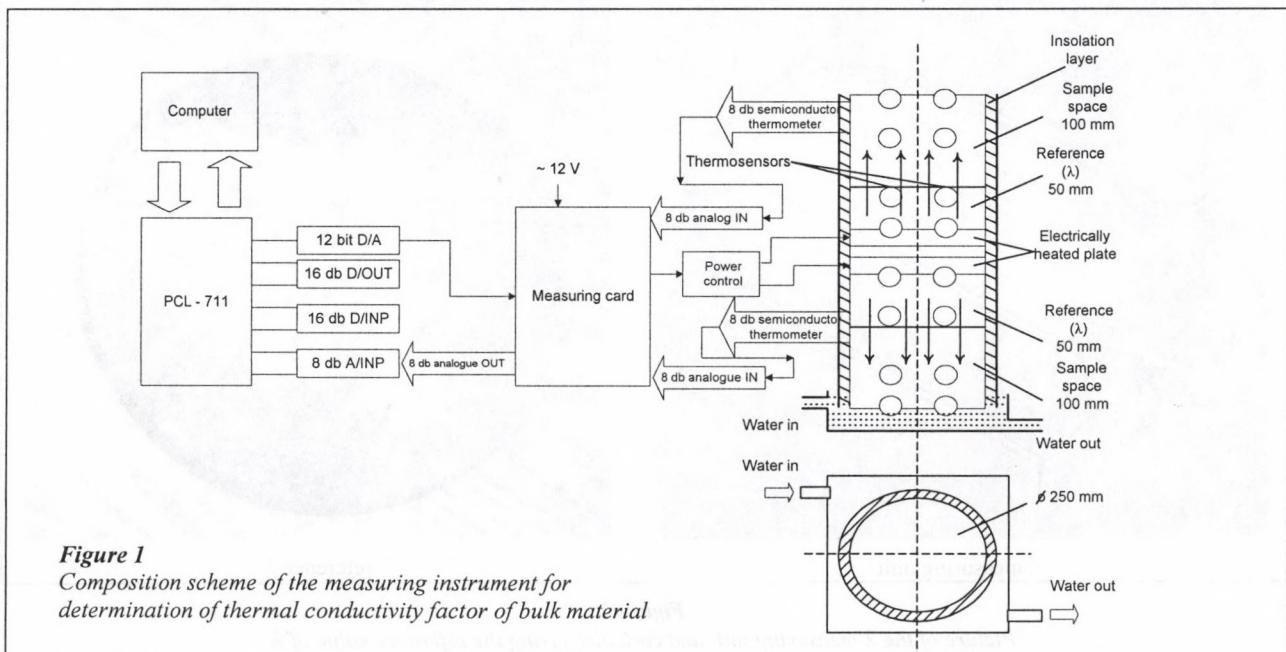

Figure 1
Composition scheme of the measuring instrument for determination of thermal conductivity factor of bulk material

The instrument consists of two cylinders that can be put each into other, two electric heated plates, one-and-one cork disk used as etalons to the instrument-halves respectively, 8-and-8 semi-conducting thermometers and suitable parts for the inlet and outlet of the water.

The measurements can be carried out on the samples made of equably dense grains and grits of 10 cm thickness in the sample-space. In the space between the two cylinders, tap water flow is driven ensuring the constant temperature, the route of the heat flow and the temperature independent from the environment. The electrically heated plate keeping on $T = 80\text{ }^{\circ}\text{C}$ ensures the constant temperature.

The temperature difference between this and the temperature of tap water (that can be measured on the two sides of the sample) generates the stationary heat flow. On the top and the bottom of the reference cork of known thermal conductivity factor, the temperature values (t_1 and t_2) are measured.

The temperature is measured on the top (t_3) and the bottom (t_2) side of the sample space as well. The λ_{sample} can be computed from the measured difference between the temperature values and the known parameters according to the above way described.

The 8 semi-conductor thermometers are connected to the measuring card. (Advantec PCL-711). The power of the heating plates is changed so that the temperature is controlled steadily and the regulator algorithm is running at every sampling as well.

The complete measurement unit performs basically two tasks: the scanning of the 8-8 thermometers placed into the probe and the transfer of the data into a txt file and additionally the control of the heating plate of temperature

$T = 80\text{ }^{\circ}\text{C}$ is set with the help of unit of triac. The temperature T can be set from the program.

The photo-picture of the λ -measuring unit and the cork disk giving the λ reference value can be seen in **Figure 2**.

The evaluation in Microsoft Excel from the resource file i.e. the txt file generated by the program is shown in **Figure 3**.

The time of sampling is settable and between two sample-taking the temperature of the heating plate of $T = 80\text{ }^{\circ}\text{C}$ is regulated. According to the experiences, the constant heat flow is realized so real λ value can be obtained.

A comparing evaluation can be seen in **Figure 4** that was carried out with two kinds of wheat and within the same kind, the grain and its grits of middle particle size by their thermal

conductivity.

The comparison of this equipment with the instrument type HOLOMETRIX RAPID-k UT 250-A and UT 400-A 1 is under work yet.

Different mean value of temperature of sample were set with the help of programing the heated plate to different temperatures at the wheat sample (GK-Élet, Csárdás) during the examination of the function $\lambda=f(t)$.

Comparing the results to the data measured by the instrument HOLOMETRIX RAPID (made in USA), the deviations are negligible i.e. the comparison shows a good accordance.

The 1°C changing in the mean temperature of sample effected $\Delta\lambda=0,005\text{ W/m}^{\circ}\text{K}$. The error inside the measuring range can be accepted to be linear. **Figure 5**.

We intend in further reasearch work to measure λ in vacuum too.

$$\lambda_{\text{cork}} = 0,048\text{ W/m}^{\circ}\text{K}$$

	In our laboratory Value of λ $\Delta T = 15^{\circ}\text{C}$	ÉMI reference λ $\Delta T = 10^{\circ}\text{C}$
Corn w=13,5%	0,128	0,1398
GK-Élet (grain) w=12,5%	0,1215	0,1306
Csárdás (grain) w=11,8%	0,125	0,1310
GK-Kalász (grits) w=12,1%	0,135	0,1317

References

- [1] Thermal Properties of Foods and Agricultural Materials N.N Mohsenin Gordon and Breach. Sci, Publ. London 1980
- [2] Powell, R W. Thermal Conductivity Determinations by Thermal Comparator Methods, Chapter 6 in thermal Conductivity, Academic Press London 1969. pp. 275-338.
- [3] BEKE, János – VAS, Attila: Testing the Drying Process of Shelled Corn on Aspects of Nutritional Quality and Thermal Efficiency. Drying Technology. Special Issue. 1994.5.1007-1027 p.
- [4] Sensors A Comprehensive Survey, Vol. 4. Thermal Sensors Editors: T. Ricolfi, J. Scholz, VCH New York 1992

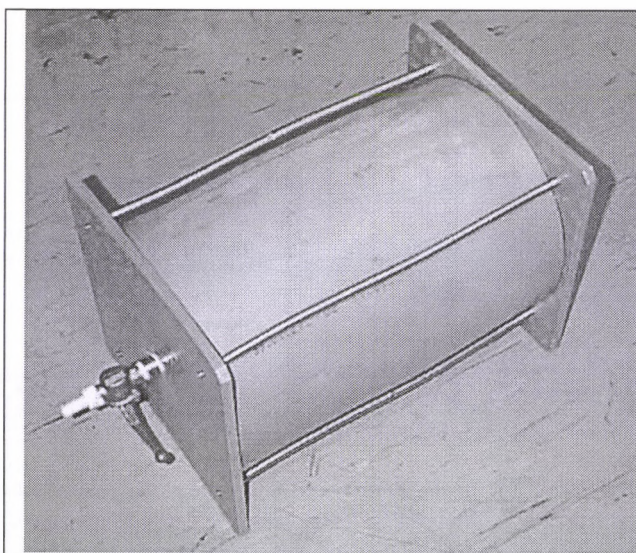

λ measuring unit

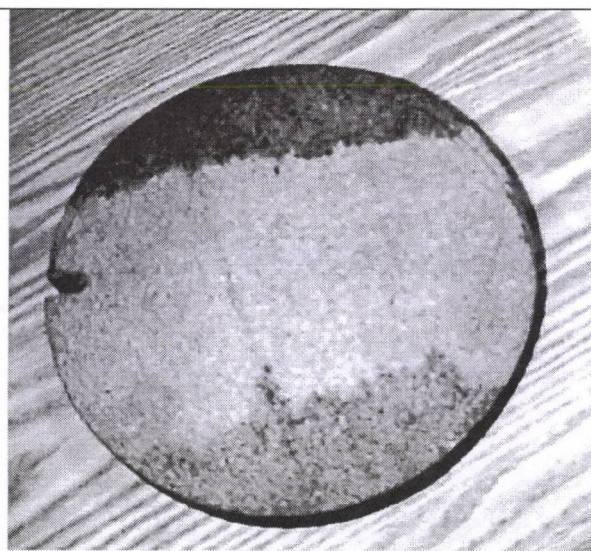

reference λ

Figure 2

Picture of the λ measuring unit and cork disk giving the reference value of λ

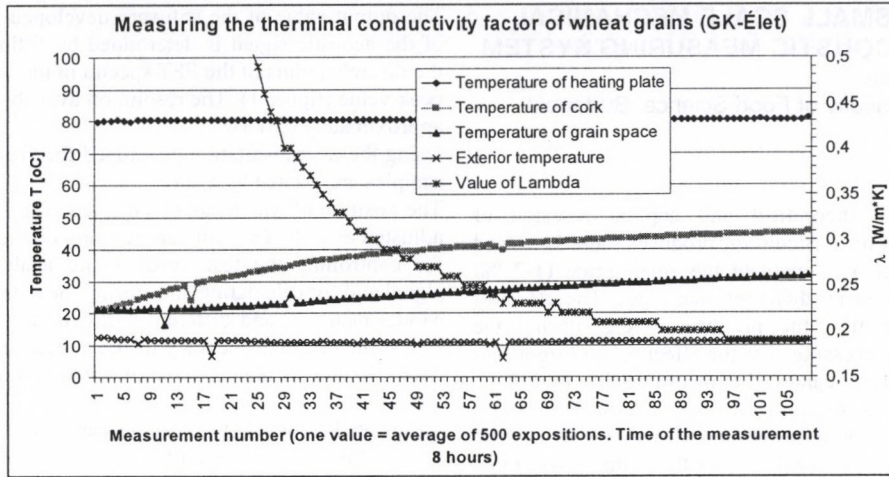

Figure 3

Evaluation in Microsoft Excel from the txt file (as resource file) generated by the data collecting program

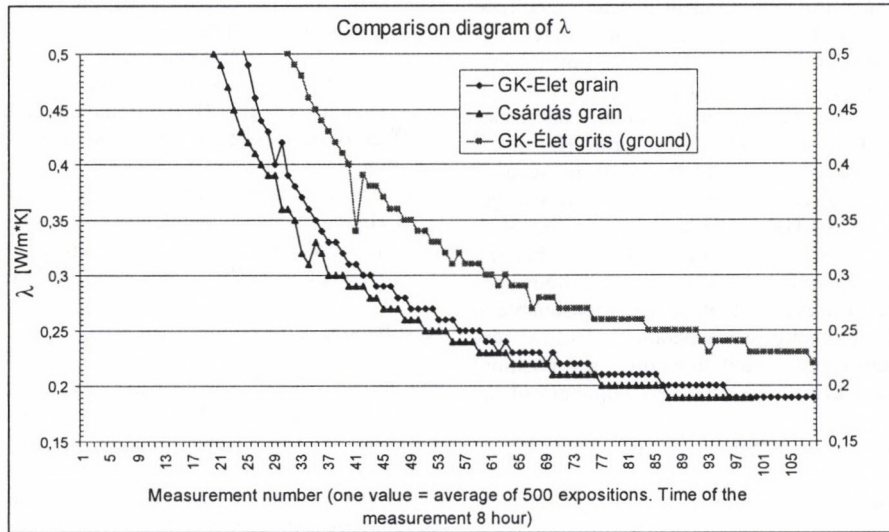

Figure 4

Comparing evaluation

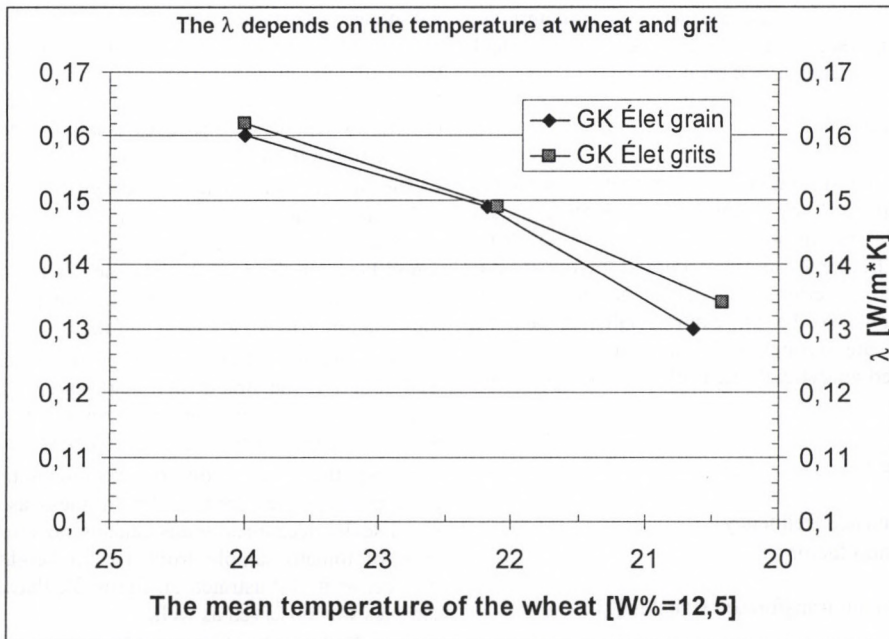

Figure 5

The λ depends on the temperature at wheat and grit

DETECTION OF SMALL SCALE MECHANICAL CHANGES BY ACOUSTIC MEASURING SYSTEM

J. Felföldi – A. Fekete

BKAE University, Faculty of Food Science, Budapest

Introduction

On the field of the theoretical and applied research of mechanical properties of horticultural produces there is a need for methods to detect and evaluate the small scale (1-2 %) firmness changes caused by different load types. The effect of dropping, pushing, hitting the produces – e.g. during the harvest, transport or processing – or the effect of the turgor loss due to a surface injury cannot be measured by traditional (compressive) methods because of their destructive nature and/or the relatively poor repeatability. However the acoustic response method can be an ideal tool for this purpose due to its absolutely non-destructive behavior and very good reproducibility. The result of the acoustic test is a resonance frequency given by the spectrum of the acoustic response signal therefore the resolution of the measurement is determined (and limited) by the Fourier transformation method used for calculation of the spectra. In the case of the test of horticultural products the duration of the acoustic signal is typically 10-100 ms, consequently the best resolution available using Fast Fourier Transform (FFT) algorithm is several Hz (it is determined by the reciprocal value of the length of the acoustic response signal, e.g. in the case of 250 ms total record length the resolution is $1/250 \text{ ms} = 4 \text{ Hz}$). It is usually not enough at all for a quasi continuous investigation of the small scale changes. The resolution can be increased by mathematical methods used in the data assessment. However in that case it is reasonable to develop and apply an automatic test apparatus to ensure very stable excitation circumstances (excitation force and position) as well to eliminate any disturbing variable component of the tests.

Therefore our aim was to develop a dynamic measurement system for

- automatic repetitive acoustic excitation of horticultural products (fruits and vegetables) with high precision
- determination of the resonance frequency with significantly increased resolution using appropriate algorithm.

Further objective of the work presented here was to determine whether this system is suitable for the measurement of small scale mechanical changes in different products.

Materials and methods

The resolution of the measurement of the resonance frequency can be increased significantly by fitting an appropriate curve on the discrete (e.g. 4 Hz resolution) values of the FFT-spectrum near to the resonance frequency and determining the maximum-location of this fitted function. Supposing the time-domain acoustic response signal to be an exponentially attenuating sinusoidal oscillation the frequency domain transform of the signal can be described analytically as well. If the time-domain signal is:

$$U(t) = e^{-\alpha t} \cdot \sin(2\pi f_0 \cdot t)$$

where - f_0 : the resonance frequency
- α : attenuation factor

then the frequency domain transformed signal is [1]:

$$S(f) = \frac{2\pi f_0}{(\alpha + 2\pi f i)^2 + (2\pi f_0)^2}$$

The output value of the software developed for the assessment of the acoustic signal is determined by fitting this function on the discrete points of the FFT spectra in the neighborhood of the peak value (figure 1). The resolution available by this method is approximately 0.01 Hz.

Using the instrumentation developed for the automatic tests the samples are excited by a stick

The position of which can be adjusted. The impact force can be adjusted as well. The software running on the fitted computer is for controlling the test, reading and analyzing the response signal and for calculating and storing the measurement results.

Model materials and different horticultural products were used to test the practical accuracy of the system and the applicability of the system for the detection of different micro-changes:

- Repeated automatic tests on the same location
 - for measurement of the effect of short/medium time storage (water-loss, turgor-loss)
carrot, apple ((Idared, Jonagold, Golden), tomato (Credito), melon (Solar King))
 - for the investigation of the effect of the repeated mechanical impacts
 - (apple (Idared), tomato (Heinz), melon, onion (Grano))
- Effect of the mechanical load (drop tests)
(tomato (Credito, Brillant), melon, onion)
- Effect of the excitation position (tests of rotated samples around their equator)
(model-materials (rubber block, plastic block), apple (Idared, Gloster), onion (Makói lila))
- In-vivo tests (effect of the physiological processes)
(tests on individual apple samples (Idared) on trees)

Results and conclusions

The acoustic measurement system developed for high resolution repeated tests was found to be suitable for measurement of the acoustic stiffness factor change of different horticultural products. In the majority of the processes in question the change of the sample mass is negligible, so it is enough to concentrate on the frequency change.

– Firmness change of a carrot sample in several minutes is illustrated on figure 2. According to the figure it can be concluded that besides the resonance frequency the bandwidth parameter – characteristic for the attenuation of the sample – can be informative too. According to analysis of variances of the results the practical frequency resolution of the system was found to be equal to $\pm 0.2 \text{ Hz}$. Conclusively in the given case (where the resonance frequency is approximately 400 Hz) 0.1% change in the firmness can be detected.

– The system was found to be suitable for repeated tests of individual samples for several hours or days. For example, in the case of the carrot samples strictly monotonous relation was found between the mass loss of the sample and the decrease of the acoustic resonance frequency. The percentage changes of these parameters are in the same range.

– The mechanical effect of the acoustic excitation on the sample was found to be practically negligible. After an initial very small scale increasing of the firmness the effect of several hundred (or several thousand) tests is less than 1%.

– Using the high resolution system statistically significant changes were measured in the firmness as the effect of very small scale mechanical loads causing no visual destruction (e.g. drop of tomato sample from 10 cm height onto a rigid flat surface, as it is illustrated on figure 3). Partial relaxation of the samples was observed as well.

– In preliminary in-vivo test of apple samples the system was found to be suitable to measure the acoustic frequency of individual samples on the trees during their ripening process.

According to figure 4 a synchronous change of the firmness of the tested samples was observed during a 2 week experiment. This trend was interrupted only in the case of samples falling down spontaneously.

References
 [1] A. Ambardor, Analog and Digital Signal Processing, PWS Publishing Co., Boston, 1995.

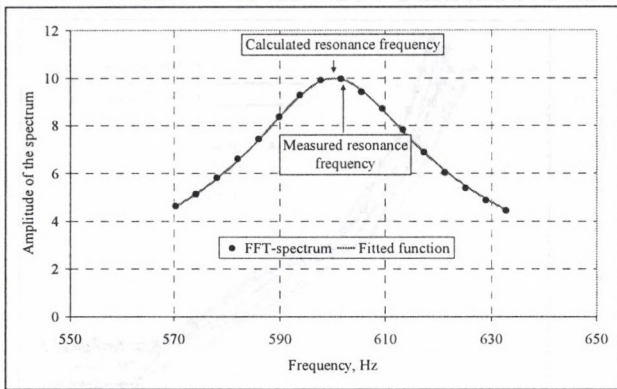

Figure 1

Increasing the frequency resolution by a suitable fitted function

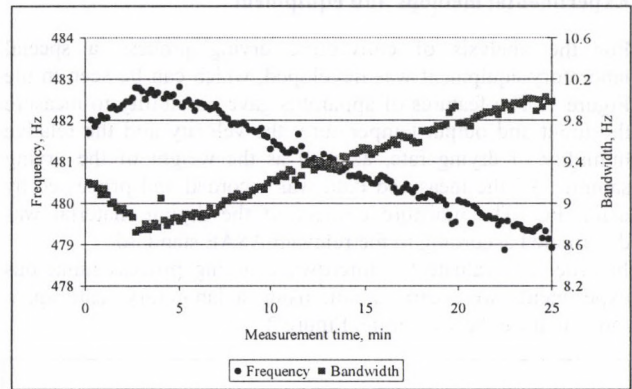

Figure 2

Result of the measurement with increased resolution on a carrot sample (acoustic frequencies vs. the measurement time)

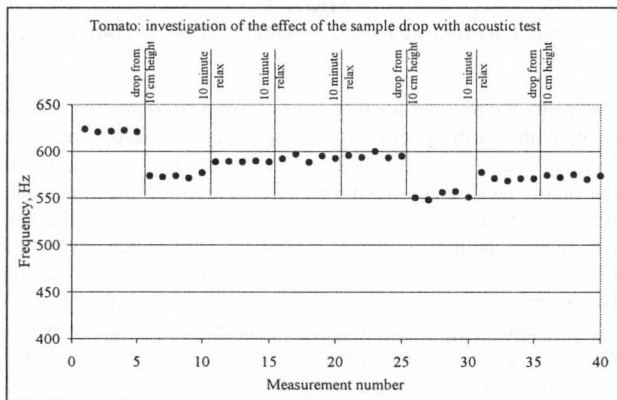

Figure 3

Effect of a drop test on the acoustic stiffness of a tomato sample (acoustic frequencies vs. the measurement number drop height: 10 cm)

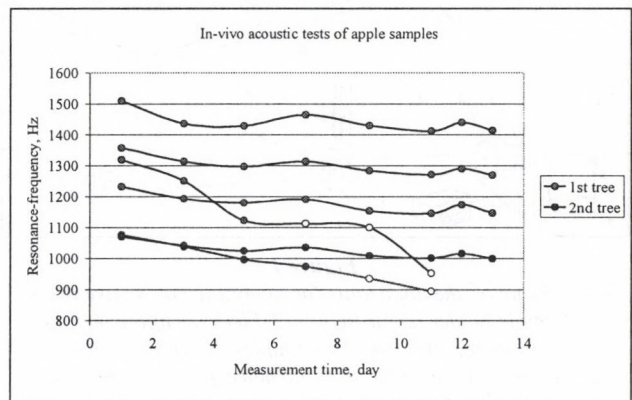

Figure 4

Frequency results of the acoustic tests performed on apples on trees vs. the time during the ripening (Cultivar: Idared, empty markers used for samples falling down during the test period)

SOME PROPERTIES OF PARSLEY LEAVES DRYING

J. Beke
Szent Istvan University, Gödöllő

Experimental methods and equipment

For the analysis of convective drying process a special laboratory equipment was developed, which can be seen in the Figure 1. The features of apparatus gave possibility to measure the input and output temperature, the velocity and the relative humidity of drying rate, as well as the weight of the drying sample. All the measured data was recorded and processed by using PC. The moisture content of the drying material was determined according to the relevant ASAE standard. In order to evaluate the microwave drying process numerous experiments were carried out, using a laboratory-scale apparatus, that can be seen in the Figure 2.

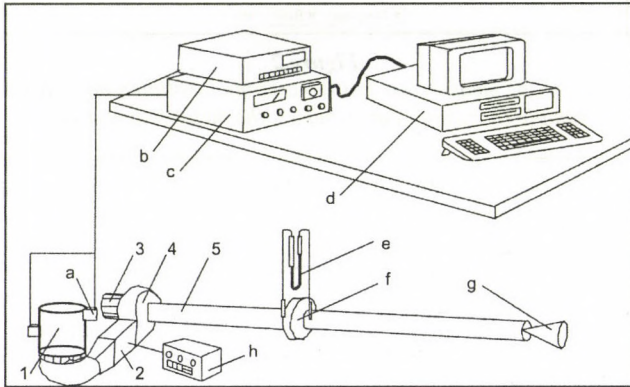

Figure 1

The scheme of the apparatus for analyzing convective drying
1-Sample holder, 2-Air heater, 3-Electric engine, 4-Fan, 5-Measuring tube, a-thermocouples, b-dew point meter, c-interface, d-computer, e-manometer, f-measuring flange, g-throttle cone, h-temperature control unit

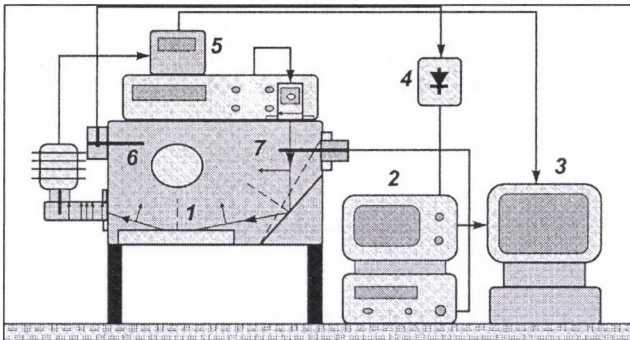

Figure 2

Structure of apparatus for microwave experiments
1-treating chamber, 2-spectrum analyzer, 3-computer, 4-detector, 5-microwave control unit, 6-receiving antenna, 7- emitting antenna

Results and discussion

Convective drying experiments

Because the stalk and the leaf have significantly different kinetic curves it is evident that the two components have dissimilar water loss properties. The integrated (average) moisture content comes from the weighted average of the typical water content of the two components thus, the kinetic curves – strictly speaking – are not symmetrical to the mean moisture content curve. However the plotted kinetic curves show a classically typical forms of agricultural products.

The intensity of the water loss process is demonstrated by the drying rate curves. As the Figure 3 shows the typical three periods of the drying process can be observed in both cases (when the air velocity is 0.4 and 0.8 m/s). In both cases the stalk has the longer constant drying rate period.

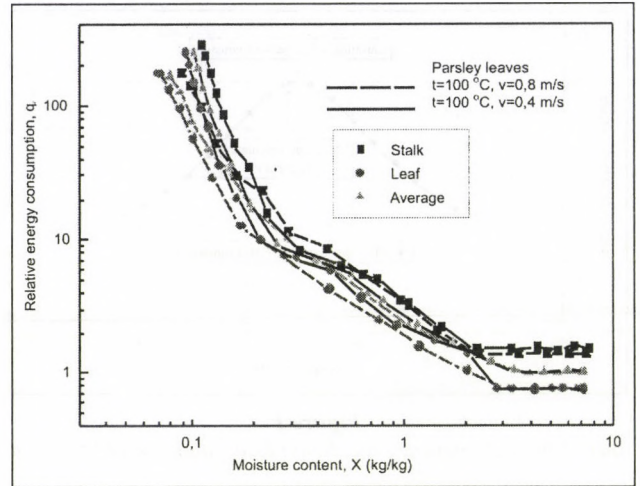

Figure 3

Typical drying rate curves of parsley leaves in convective drying

The probable reasons for that can be found in its smaller special surface and in the peculiarity of the inner moisture movement. Namely it can be assumed from the morphological structure of the plant, because the outer epithelium creates some water confining layer and the inner vascular system promotes the longitudinal moisture movement. There are similar reasons for the higher maximum drying rate of 20 % in the case of leaf drying. However, difference of similar degree cannot be experienced in the average integrated moisture content for the whole drying rate, because in the last period of the water loss process that difference is equalized gradually. By improving the air velocity from 0.4 m/s to 0.8 m/s increases the drying rate by 15-20 %. Analysis of the relationship between the moisture content (on dry basis) and the energy consumption of drying process is illuminating (Figure 4).

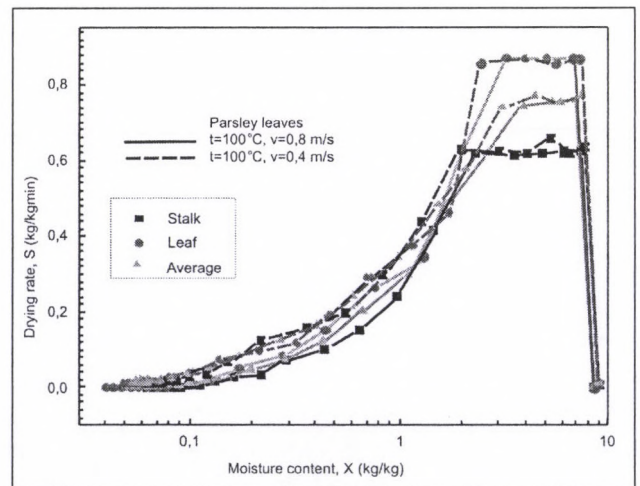

Figure 4

Energy consumption of convective drying process of parsley leaves

By supposing an equalized distribution of inlet energy between the stalk and the leaf a larger heat and mass transport rate is established in the case of leaf drying. The lines illustrated the energy consumption run nearly parallel in the constant drying

rate period. The falling rate period can be divided into two intervals: a evenly and an asymptotically decreasing section. In all three drying periods the leaf drying process needs fewer energy, nearly to the same extent. It should be mentioned that the above findings are valid on the basis of equivalent moisture content. It is hard to avoid overdrying of components because of the quicker leaf water get-off.

Microwave drying experiments

By analysing the drying process more accurately it turns out that in the case of microwave drying the stalk drying rate exceeds the similar parameter of leaf (Figure 5). This phenomenon contradicts the convective experiences. This phenomenon can be led back at least to two probable reasons. On one hand as a result of microwave absorption the temperature gradient has an opposite direction, compared to the convective case.

On the other hand the degree of energy absorption is not in a close connection with the surface heat and mass transfer coefficient or the specific water get-off surface

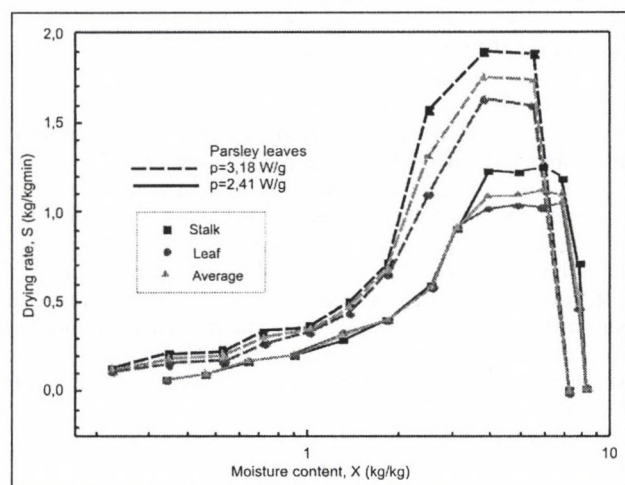

Figure 5

Typical drying rate curves of parsley leaves under microwave conditions

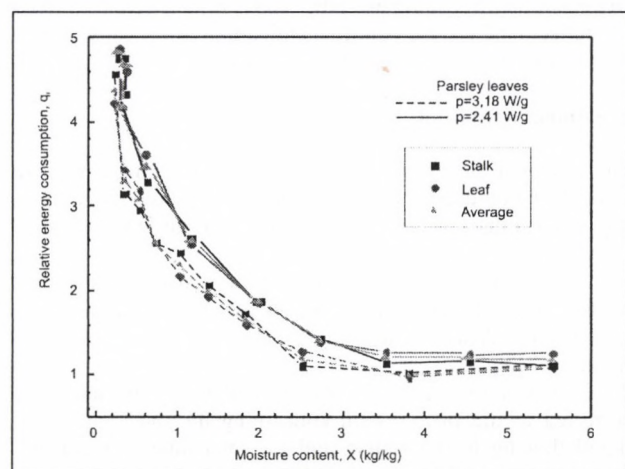

Figure 6

Energy consumption of microwave drying process of parsley leaves

In these conditions the confining effect of surface epitheliums is nearly negligible. Because of the inner heat production, a significantly larger diffusion coefficient can be experienced, consequently the moisture movement rate increases. On all these bases it can be supposed that an intensive moisture movement is established in the vascular systems, which leads

the majority of water content from the stalk to the leaf, causing more intensive water loss in the stalk. It is seen that the earlier hypothesis is also supported by the obtained q_r -X curves of parsley leaves drying (Figure 6.) As it can be seen the relative energy consumption curves, as functions of the topical moisture content, shows a shape of power function.

There are several explanations for slightly decreasing energy consumption at the beginning of the water loss process. On one hand it is certain that the energy absorption is not homogeneous in the warming up period. On the other hand the establishment of a homogeneous high-frequency field is influenced by the relationship between the main parameters of treating chamber and the properties of drying material. Disregarding the complicating factors listed in the earlier sentences in the case of microwave parsley leaves drying a nearly equable energy consumption can be recorded.

The slightly increasing energy consumption at the end of the drying process can be caused by the apparatus construction as well as the energy conversion losses. Similar results were found in the case of any applied microwave power and we did not find significant difference in energy consumption of stalk and leaf drying.

Closing remarks

In the usual domain of vegetables microwave drying the drying process is divided into constant and falling rate period. As a result of the effect mechanism break points can be found on the falling drying rate curves. The probable reason for that is that the absorption of the microwave energy in the drying zone is not homogeneous (especially at the beginning of the drying process) and its absorption degree does not reach the possible maximum value.

During the drying of greens the stalks and the leaves show different water get-off features. The drying rate depends – among others – on the applied mode of the energy transport. The intensity of the convective energy transport is the function of the surface heat transmission coefficient, while the degree of microwave energy transport depends on the efficiency of absorption.

The author is grateful to the OTKA Foundation (T037420) for the financial support.

Symbols

E	Electric field strength	f	frequency
P_i	Incident performance	q_r	Relative energy consumption
P_r	Reflected performance	t	temperature, °C
P_d	Dissipated performance	τ	time (min)
S	Drying rate (kg/kgmin)	λ	wave length
X	Moisture content, dry basis (kg/kg)	ϵ''	the imaginary part of complex dielectric constant

References

- [1] Beke, J.- Mujumdar, A.S. - Bosisio, R. G.: Drying of fresh and rewetted shelled corn in microwave fields. = *Drying Technology*. 1995.1-2. 463-476.
- [2] Beke, J.- Mujumdar, A.S.- Giroux, M.: Some Fundamental Attributes of Corn and Potato Drying in Microwave Fields. = *Drying Technology*. 1997. 15. 2.
- [3] Beke, J.: The impact of field polarization on the dewatering process of corn. *Drying Technology*. 1999. 17. 4.
- [4] Beke, J.- Mujumdar, A.S.: Thermohygral properties of grains. In: *Drying Technology in Agriculture and Food Sciences*. Edited by A.S. Mujumdar. Science Publisher Inc., Enfield (NH), USA, 2000.
- [5] Bengston, N.- Risman, P.: Dielectric properties of foods at 3 GHz as determined by a cavity perturbation technique. *J. Microwave Power* 6. 1971 pp. 107-123.
- [6] Beke, J.- Kurjak, Z.- Bihercz, G.: Microwave field test of inner moisture and temperature conditions of beetroot. *Drying2002*, Beijing, 2002. pp.

APPRECIATION OF AN COMPLEX ULTRASOUND SYSTEM ACCORDING TO THE SURVIVAL CELL COUNT

A. Lőrincz – M. Neményi

University of West Hungary, Mosonmagyaróvár

Introduction

There is no cavitation in the ultrasound field until the amplitude of the acoustic pressure exceeds a certain level, the cavitation threshold [1]. Cavitation threshold is proportional with the frequency of ultrasound, with the hydrostatic pressure in the liquid, and with the viscosity of the sample and it is inversely proportional with the gas content and temperature of the sample [2]. There are two types of cavitation that are stable and transient cavitation [3]. Basically two reactions take place when ultrasound and a media interact with each other. One of them is the absorption the other one is the scattering, which changes e.g., the speed of propagation of the sound in the subject media [4]. Due to the absorption, the intensity of ultrasound decreases exponentially with distance and the absorption coefficient primarily depends on the speed of propagation of the sound in the subject media, on the wave type, on the material situated in the ultrasound field and on the frequency. The absorption always characterizes a media, a structure or an environment that determines the parameters of propagation [5]. When absorption coefficients were measured in oxo- and methemoglobin, it was observed that the absorption is proportional with the concentration of hemoglobin in the concentration range between 0 and 15 [g/100ml] [6]. It was clearly established that the profile of the ultrasound propagation speed depends on the concentration profile of the suspension [7]. Effects of the size and concentration of the suspended particles on the propagation speed of ultrasound was examined in water based suspensions. It was established that the speed of sound largely depended on the particle size and concentration [8]. In vitro cavitation threshold measurements were carried out in human blood. In the fresh blood that contained every blood component, the amplitude of the acoustic pressure belonging to the cavitation threshold was higher than in diluted blood [9]. Due to cavitation caused by ultrasound, acoustic streaming was formed in the liquid [10]. Acoustic streaming is a movement of the liquid that is caused by intensive ultrasound [11]. Mixing of liquid was experienced in the ultrasound field due to acoustic streaming [12]. An acoustic reflector placed opposite to the transducer causes a standing wave to be formed. In a standing wave the materials whose density are lower and higher than of the liquid drift to propagation cluster planes (pressure antinodes), and pressure nodes, respectively [2]. The ultrasonic separation is used in analytical biotechnology applications. This procedure is based on the fact that in a standing wave field, where there is no cavitation, the cells are arranged in bands distances of which are smaller than a millimetre and they can be separated from these bands [13]. Yeast (*Saccharomyces cerevisiae*) and rubber particles were manipulated in a standing wave ultrasound field at frequencies of 1 and 3 [MHz]. The particles formed bands in pressure nodes whose distance from each other was equal to half of the wavelength. In the direction of the radiation the bands formed column like structures. Stability of the bands, the conditions under which they are broken and the formation of the acoustic streaming were investigated in [14]. Effectiveness of the cell separation of *Escherichia coli* bacteria and *Saccharomyces cerevisiae* yeast cells from a yeast suspension was examined at frequencies of 1 and 3 [MHz] [16]. The effects of microwave is very similar to the actions of ultrasound on the biological materials [17], [18], [18], [19].

Materials and methods

1,8g of pressed *Saccharomyces cerevisiae* yeast microbe was suspended in 200cm³ of distilled water with a magnetic stirrer until it became clod free and the cell concentration reached the level of 9x10⁷/ml. For the sake of a better detection we put 5 drops of methylene blue into the solution, which did not influence the vitality of the micro organism.

We put the suspension into a flow injection system (Fig. 1.) of 100 cm³ of inner volume with a peristaltic pump. After the filling and short-circuit of the system the suspension was circulated by a peristaltic pump between the different structural units. The suspension was then not directly treated but isolated from its environment by material flow through ultrasonic flow cuvettes (Fig. 1.) especially made for this purpose. The ultrasonic cuvettes allow the suspension to flow with a surface of 1 cm² and a thickness of 0.5 mm. There were two cuvettes placed 1 cm apart at right angles to the flow direction. The reason for this arrangement was that the effects on the liquid film are much easier to observe than inside the material. In order to avoid cell sedimentation an efficiently high rate of flow was applied: 50-70 cm/sec (4-5 cm³/sec). The suspension flowing in the ultrasonic cuvettes were exposed at a frequency of 0.8 MHz and at a capacity of 10 W/cm². The suspension flowing in the system gets into an optical detection cell placed in a biological microscope. The picture gets then from here through a CCD camera into a computer system, where it will be saved according to time units. Which will allow evaluating the cell disruption effect of the treatment based on calibration. After short-circuit the flow system and turning on the ultrasonic system there were drop samples taken at time units through a built-in tap. The samples were immediately analyzed under a Buerker chamber. A thermostat unit also belongs to the system, which ensures a constant temperature for the reproduction of the tests.

The survive cell analysis is based on a vital stain, which means that under microscope with Buerker-chamber. The dead cells are stained blue owing to methylene blue but the living organisms remain clear. We can establish the curve of deteriorated and survived cells owing to ultrasonic treatment as blue stained and clear cells are counted at regular time units. Organisms are regarded as cells, which have intact cell walls and reflect vitality. We want to mention this fact because after a certain time of treatment cell lysis will happen.

Treatment definition

The treatment means a certain period of time during which the amount of liquid circulating in a flow system is exposed to a physical (ultrasonic) treatment of a given capacity during a given period.

The time of treatment means in the flow system the period between the turning on and turning off the ultrasound. This period was taken into account during the evaluation of the results.

As for the amount of liquid the time of treatment had to be corrected in the flow system concerning the total amount of liquid flowing in the system and the total time of treatment. Therefore the total liquid treatment time of „A” is required to reduce the original cell count to its hundredth where „B”=100cm³ is the total amount of flowing liquid in our system. So 1 cm³ of cell suspension has to be treated at „A/B” minute.

Results and discussion

Treatments were carried out at 0,8 MHz and with a capacity of 7,5 W/cm²; 9,6 W/cm²; 10,5 W/cm² and 12 W/cm² by taking samples from the suspension at defined times. These samples

were then evaluated in Buerker chambers based on the average living and dead cell numbers to be observed. Figure 2 showed the relative percentage of survive cell counts in the samples. According our examinations the relative surviving cell counts of one milliliter treated suspension showed on Table 1. On Fig. 2, the $\diamond = 7,5 \text{ W/cm}^2$, $\square = 9,6 \text{ W/cm}^2$, $\Delta = 10,5 \text{ W/cm}^2$, $X = 12 \text{ W/cm}^2$ are the points belonging to the ultrasonic treatments and the functions fitted to them. The relative living cell counts signified by the different symbols show that more drastic and faster cell destruction is to be observed depending on the time passed if we applied higher capacities. In Table 1 the relative cell counts refer to 22 cells per Buerker chamber owing to creating the model function, which indicate an initial cell count of $8,8 \times 10^6/\text{ml}$. In order to set up a model formula we set different trend functions onto the points. The logarithmic trend functions showed the highest correlation with the measured points. Setting trend functions on to the additive and multiplying factors of the logarithmic functions resulted in the formula shown in Table 2, where „a” is the trend function referring to the additive factor and „b” is the trend function referring to the multiplying factor. Cell count can be omitted from the model formula as it refers to the initial cell count of 22 cells / Buerker chamber unit, so it has to be corrected by the actual cell counts respectively. This model function helps to calculate the ultrasonic capacity that is required for treating the material at a given initial cell count, so that it would reduce to the required cell count after a certain period of time. Or it allows determining the time needed to reach the required cell count at constant ultrasonic capacity. Of course these values refer to a given system. Therefore a correction factor is to be used for a general usage adapted to the actual conditions. Fig. 3. shows the replacement of the treatment of 7.5 W/cm^2 .

Conclusion

The model function allows modelling the effects of the ultrasonic treatment at a frequency of around 0,8 MHz and different capacities.

The ultrasonic treatment can be adapted for use for treating agricultural products if high quality is required.

Acknowledgement

We express our thanks for the help of Prof. Dr. Pál Greguss from the Technical and Economic University of Budapest.

References

- [1] F. J. Fry, *Ultrasound: Its Applications in Medicine and Biology*, Elsevier Scientific Publishing Company, Amsterdam-Oxford-New York. 1978
- [2] G.R. Ter Haar, *Biological Effects of Ultrasound in Clinical Applications*. In: S.K. Suslick, *Ultrasound, Its Chemical, Physical, and Biological Effects*. VCH Verlagsgesellschaft mbH, Weinheim. 1988 pp 305-319.
- [3] L.A Frizzel, *Biological Effects of Acoustical Cavitation*. In.: S. K. Suslick, *Ultrasound, Its Chemical, Physical, and Biological Effects*. VCH Verlagsgesellschaft mbH, Weinheim. 1988 pp 287-301.
- [4] C.R. Hill, – R.C. Chivers, – R.W. Huggins, – D. Nicolas, *Scattering of Ultrasound by Human Tissue*. In.: F. J. Fry, *Ultrasound: Its Applications in Medicine and Biology*. Elsevier Scientific Publishing Company, Amsterdam-Oxford-New York 1978 pp 441-493.
- [5] H. Kuttruff, *Ultrasonics Fundamentals and Applications*, Elsevier Applied Science, London and New York. 1991
- [6] E.L. Carstensen, H.P. Schwann, *Acoustic Properties of Hemoglobin Solutions*, *J. Acoust. Soc. Amer.* 31 1959 p 305.
- [7] D.J. Wedlock, C.J. McConaghy, S. Hawksworth, *Automation of ultrasound velocity scanning for concentrated dispersions*, *Colloid and Surfaces A: Physicochemical and Engineering Aspects*. 77 1993 pp 49-54.
- [8] P. Sayan, J. Ulrich, *The effect of particle size and suspension density on the measurement of ultrasonic velocity in aqueous solutions*, *Chemical Engineering and Processing*. 41 2002 pp 281-287.
- [9] C.X. Deng, X. Quihong, R.E. Apfel, C.K. Holland, *In vitro measurements of inertial cavitation thresholds in human blood*, *Ultrasound in Med. and Biol.* 22 1996 pp 939-948.
- [10] A.H. Saad, A.R. Williams, *Possible mechanisms for the agitation-induced enhancement of acoustic cavitation in vitro*, *J. Acoust. Soc. Am.* 78 1985 pp 429-434.
- [11] H. Mitome, *The mechanism of generation of acoustic streaming*, *Electronics and Communications in Japan*, Part 3. 81 1998 pp 1-8.
- [12] D.J. Watmough, K.M. Quan, M.B. Shiran, *Possible explanation for the unexpected absence of gross biological damage to membranes of cells insonated in suspension and in surface culture in chambers exposed to standing and progressive wave fields*, *Ultrasonics*. 28 1990 pp 142-148.
- [13] W.T. Coakley, *Ultrasonic separations in analytical biotechnology*, *Trends in Biotechnology*. 15 1997 pp 506-511.
- [14] J.J. Hawkes, J.J. Cefai, D.A. Barrow, W.T. Coakley, L.G. Briarty, *Ultrasonic manipulation of particles in microgravity*, *J. Rhys. D: Appl. Phys.* 31 1998 pp 1673-1680.
- [15] J.J. Hawkes, M.S. Limaye, W.T. Coakley, *Filtration of bacteria and yeast by ultrasound enhanced sedimentation*, *Journal of Applied Microbiology*. 82 1997 pp 39-47. G. [16] G. Szabó, J. Dörnyei, J. Szilágyi, *A mikrohullámú energia hatása vérplazma és színtelenített teljes vérpor diszperz szerkezetének alakulására az agglomerálási-szárítási folyamat során*, *Élelmiszeripari Főiskola, Tudományos Közlemények*. 14 1987 pp 81-87.
- [17] J. Varga, K. Rigó, Cs. Lamper, J. Téren, G. Szabó, *Kinetics of Ochratoxin A Production in Different Aspergillus Species*, *Acta Biologica Hungarica*. 53 2002 pp 381-388.
- [18] L. Tanács, J. Soós, L. Gerő, L. Fehér, K. Rigó, G. Szabó, *Fungicidkezelt búzaállományok sütőipari paramétereinek, mikroflórájának és ergosterin szintjének alakulása*, *V. Nemzetközi Élelmiszertudományi Konferencia*. Szeged, 2002. Október 24-25. (CD-ROM)
- [19] K. Rigó, G. Szabó, J. Terén, J. Varga, *Application of Microwave-Assisted Ergosterol Extraction (MAE) Method to Assess Fungal Contamination in Plant Products EUROFOODCHEM XI*. Norwich Research Park. *Biologically-Active Phytochemicals in Food*. Edited by: W. Pfannhauser, G. R. Fenwick & Khokhar (ISBN 0-85404-806-5) pp 253-255.

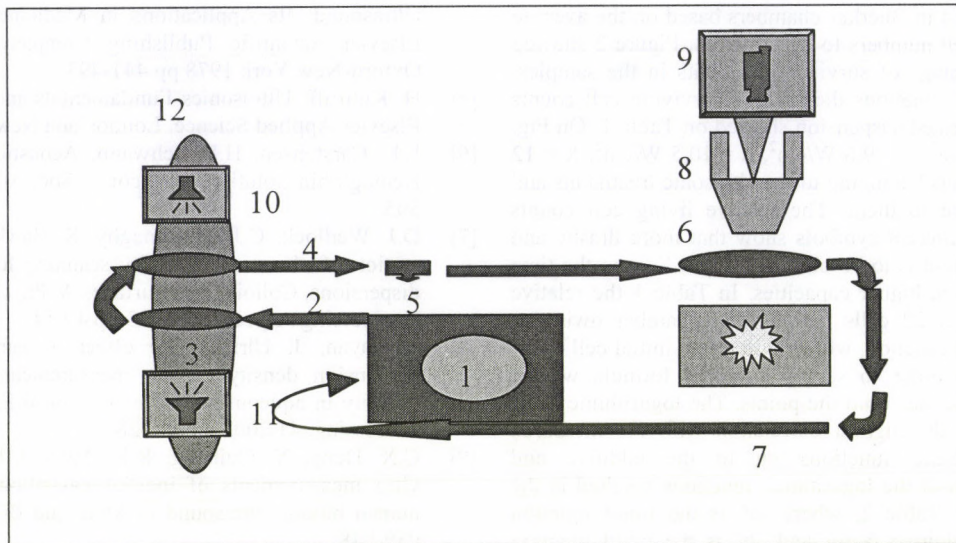

Figure 1

The complete flow injection system. Key: 1. Peristaltic pump, 2. Lead out tube, 3. Ultrasonic treating cuvettes, 4. Tube, 5. Tap, 6. Optical flow cuvettes, 7. Lead in tube, 8. Light microscope, 9. CCD camera, 10. Ultrasound transmitter, 11. Ultrasound receiver, 12. Echoless water bath.

Table 1 Relative survivor cell counts of one millilitre treated cell suspension after different exposition times

Ultrasound output power	7,5W/cm ²	9,6W/cm ²	10,5W/cm ²	12W/cm ²
Exposition time (In 1cm ³ treated suspension)	3min 29sec	2min 27sec	2min 17sec	2min 9sec
Rel. surv. cell count	1,70%	0,90%	0%	0,80%

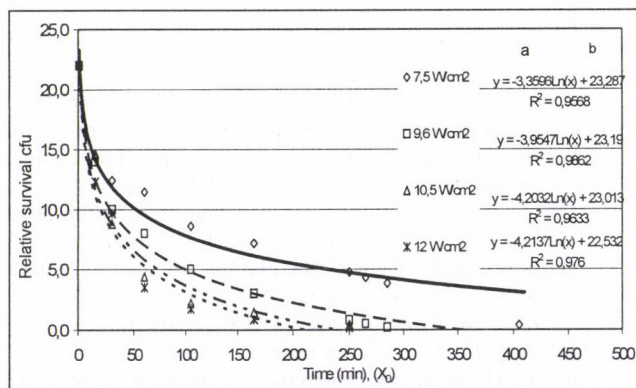

Figure 2

Model functions on the relative survival cell counts

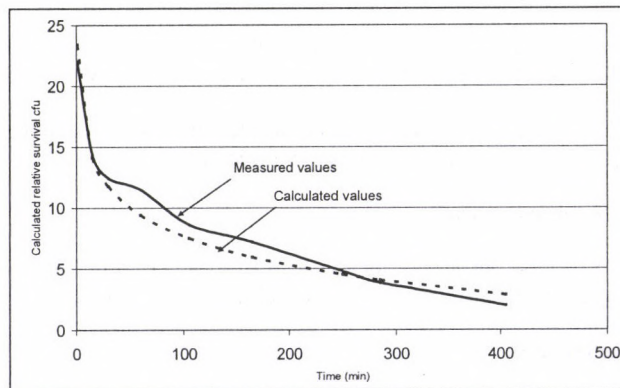

Figure 3

Model function on the real relative living cell count values

Table 2 Model functions

$y = a \ln x_0 + b$ ($x_0 = \text{time, [min]}$)	(1)
$a = -1.9376 \ln x_1 + 0.4753$ ($x_1 = \text{Ultrasound power, in W/cm}^2$)	(2)
$b = -1.5277 \ln x_1 + 26.567$ ($x_1 = \text{Ultrasound power, in W/cm}^2$)	(3)

PHYSICAL PROPERTIES OF SEEDS OF VEGETABLES

N. I. Polyák - Z. Csizmazia

Centre of Agricultural Sciences University of Debrecen

Introduction

The knowledge of the characteristics of the particles used is a key issue in the process of design of the agricultural machines. As a result, the study and investigation of the characteristics of particles used in agriculture, mainly their physical properties have become a significant area of agricultural research. Granular particles (seeds, fertilisers) are of special importance, as they come into close contact with various machines in the course of particle moving, seeding, spreading, harvesting, cleaning, drying, processing etc. (Neményi, 1985, Sitkei, 1981). The interest in physical properties of seeds and the methods for measuring them has increased during the last few years. The construction of equipment for storage, transport and distribution first of all of sowing machines is not viable without a theoretical basis and the knowledge of the physical characteristics of seeds. Coefficients of friction are of primary importance. This study, which was supported from several tender resources (National Scientific Research Foundation, OTKA T 026482, T 037921, High Education Development Project, FKFP-0011/2000, National Research Development Project NKFP-4/030) describes the methods used and the devices developed to measure the angle of repose, inner friction, friction on various surfaces and aerodynamics properties together with the measuring results.

Materials and methods

We undertook our experiments on green-peas seeds (Tyrkis). Investigations were performed in the analytical laboratory of the Department of Agricultural Engineering. The temperature of the laboratory was kept at 20 °C, relative humidity varied between 25-35%. 50 kg/air dry seed was available (for determining the angle of repose and the friction properties), which we stored in the test chamber for several months prior to the investigation. According to sampling standards, we chose 105 seeds for determining the size, shape and aerodynamic qualities. The moisture content of the samples of 3 x 25 g was defined at 103 ± 1 °C in the course of 72 hours' drying.

The angle of repose of grains was measured using a topless box made of plywood, 300x300mm in cross-section and 400mm in height, where the front panel, (with the exception of a height of 100mm) was removable. The box was filled with grain, then the front section was removed quickly but smoothly. By the aid of the grain level measurable above the outlet (a) and box size vertical to the outlet (b) the angle of repose was calculated on the principle of $\text{tg}\alpha = a/b$.

A friction-measuring device was developed (Csizmazia et al, 2001) for measuring the inner friction of grains and the degree of slide on different surfaces. The device contains a shearing box of two pieces with a cross-section of 200x200mm and with an inner height of 60mm. In the course of measuring, the lower frame of slight resistance was moved whilst passing over a row of ball bearings. An electric motor moved the drag frame with the help of diverting switches, back and forth. Between the drag frame and the shearing box a flat-link chain driven by a chain wheel established the link (closed mesh).

The cell that measured the drag force within the range of 1000N was built into the vertical pulling arm of the drag chain. Dislocation was measured by an incremental rotating transducer, producing 2000 signals per rotation. A cell to measure the power with the range of 1000N was adjusted to the top of the shearing box. Loading was performed with the help of a system of arms, with weights placed on the scales, at a gear transmission of 25x.

The equipment for the investigation of friction was supplemented by a rotating shearing apparatus to measure the inner friction. The apparatus consisted of two rings with an inner diameter of 400mm, of which the upper ring is fixed and can be loaded, the lower ring could be rotated. The diameter of the core parts of the ring was 100mm. The planes partitioning the inner space of the rings into compartments of 120°. In other respects, the apparatus is similar to the shearing box.

An elutriator was designed and constructed (Csizmazia et al, 2000) which consists of a 865mm long plexiglass vertical tube with a diameter of 100mm in which an airflow is supplied by a centrifugal fan. The air velocity was regulated with the modification of the fan's rpm. The air flowed from the fan through a plenum chamber upward into the 400mm long test zone of the elutriator. A lot of holes were bored on the mantle of the plexiglas tube along the test zone to decrease the air velocity upwards from below about 20%. This allowed the formation of a relatively flat air velocity profile in the test section.

Results and conclusions

The main characteristics of the investigated sample are in *Table 1*. The average moisture content of the samples is 9,27 %. The angle of repose is 29°. The values of friction coefficient (μ_s) measured by slide test and the inner friction coefficient (μ_i) measured with rotating shearing apparatus are in *Table 2*. The values of the μ was measured in 10-40mm range.

The smallest coefficient of friction was measured on glass, the greatest on PVC by less load and on black steel by greater load. The conclusion is important, because by other seeds was measured other results. By Polyak (2001) was measured with wheat the smallest coefficient of friction on teflon, the greatest on black steel by all loads.

On the *Figure 1* is shown the relationship between frictional force and displacement, on the *Figure 2* the relationship between coefficient of friction and displacement, both by black steel and by different loads. On the *Figure 3* is shown the relationship between frictional force and displacement by inner friction. The inner friction coefficient increased significantly by the beginning of the distance and reached the maximum values by 17-18 mm, then decreased gradually.

The aerodynamics properties of the seeds are shown in the *Table 1*. It can be concluded that the air velocity is in close relation to mass/maximum cross-section ($R=0,847$), to mass of the seeds ($R=0,7925$), to the less diameter of the seeds ($R=0,775$), and to the less cross-section of the seeds ($R=0,755$). On the *Figure 4* is shown the relationship between air velocity and mass/maximum cross-section.

References

- [1] Csizmazia Z. - Lajos T. - Marshall J. - Polyák N. I. (2000): „Új rendszerű légszatóna fejlesztése” (Development of a new elutriator), *Mezőgazdasági Technika*. 51. No.9. 2-5. p.
- [2] Csizmazia Z. - Ballo B. - Kasza F. - Polyák N. I. - Hagymássy Z. - Ancza E. - Gindert K. Á. (2001): Sűrűlődmérő készülék fejlesztése (Development of a shearing apparatus). *Mezőgazdasági Technika*. 42. évf. No. 7. 4-6 p.
- [3] Neményi M. - Szodfridt Gy. (1985): Die die Oberfläche der Körner des Hybridmais (Zea mays L.) beeinflussenden Faktoren. *Z. Acker- und Pflanzenbau*, 154, 217-221. p.
- [4] Polyák N. I. (2001): Búza vetőmag fizikai jellemzői (Physical characteristics of wheat seeds). Ph.D. tézis. Debrecen. 22. p.
- [5] Sitkei Gy. (1981): *Mezőgazdasági anyagok mechanikája* (Mechanics of agricultural materials). Akadémiai Kiadó, Budapest.

Table 1 The main characteristics of the investigated sample

Values	Minimum	Maximum	Mean	Standard deviation
D ₁	5,82	8,27	7,5	0,51
D ₂	5,17	7,6	6,62	0,44
D ₃	4,85	7,23	6,42	0,40
Sphericity	0,84	0,97	0,92	0,02
Mass of the seeds	0,114	0,346	0,253	0,045
Air velocity	10,78	13,94	12,07	0,44
K values	9,21E-06	2,03E-05	1,71E-05	2,45E-06
Drag coefficient	0,5922	0,7914	0,7169	0,0429

Table 2 Values of the friction coefficient (μ)

Surfaces	Loading								
	41 N	67 N	91 N	164 N	287 N	409 N	532 N	655 N	777 N
Stainless steel	0.235	0.227	0.196	0.192	0.217	0.235	0.228	0.226	0.225
Black steel	0.316	0.278	0.282	0.341	0.372	0.356	0.379	0.384	0.414
Bakelite	0.189	0.215	0.242	0.213	0.258	0.279	0.308	0.313	0.323
Plexiglass	0.173	0.229	0.255	0.225	0.249	0.252	0.281	0.283	0.312
Galvanized steel	0.290	0.321	0.292	0.351	0.374	0.386	0.375	0.360	0.377
Aluminium	0.289	0.329	0.298	0.363	0.356	0.375	0.373	0.357	0.364
PVC	0.309	0.385	0.391	0.374	0.387	0.384	0.382	0.365	0.373
Plywood	0.188	0.209	0.204	0.185	0.192	0.211	0.211	0.253	0.213
Teflon	0.240	0.200	0.207	0.191	0.187	0.182	0.171	0.169	0.159
Glass	0.120	0.117	0.121	0.111	0.103	0.121	0.126	0.134	0.140
Inner friction coeff.	0.808	0.620	0.654	0.767	0.772	0.774	0.751	0.758	0.731

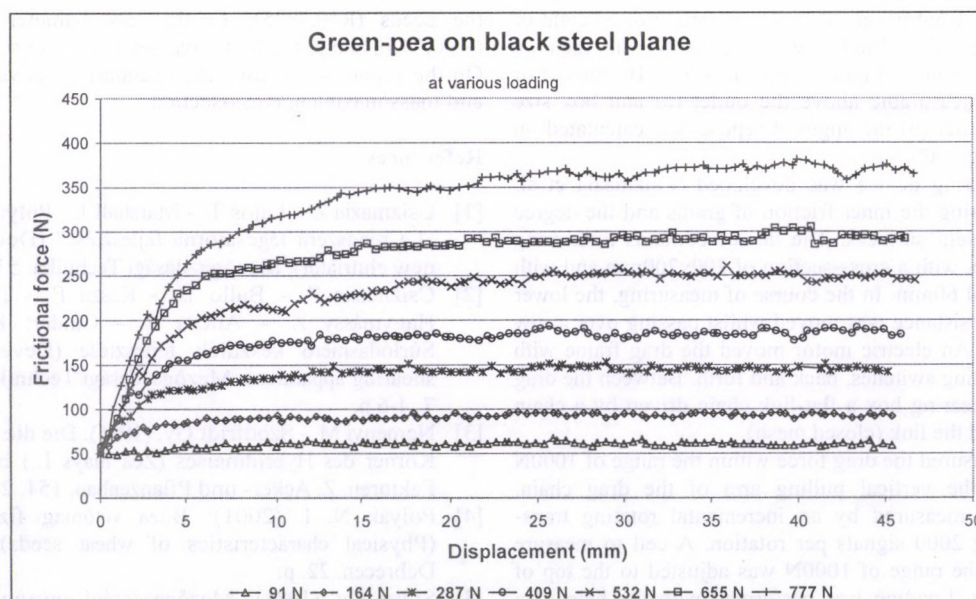

Figure 1
Relationship between frictional force and displacement on black steel

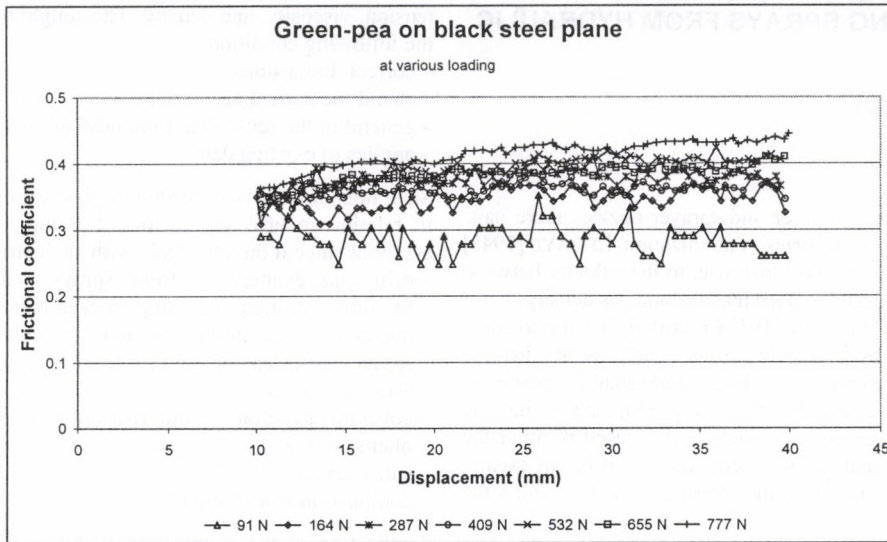

Figure 2
Relationship between frictional coefficient and displacement on black steel

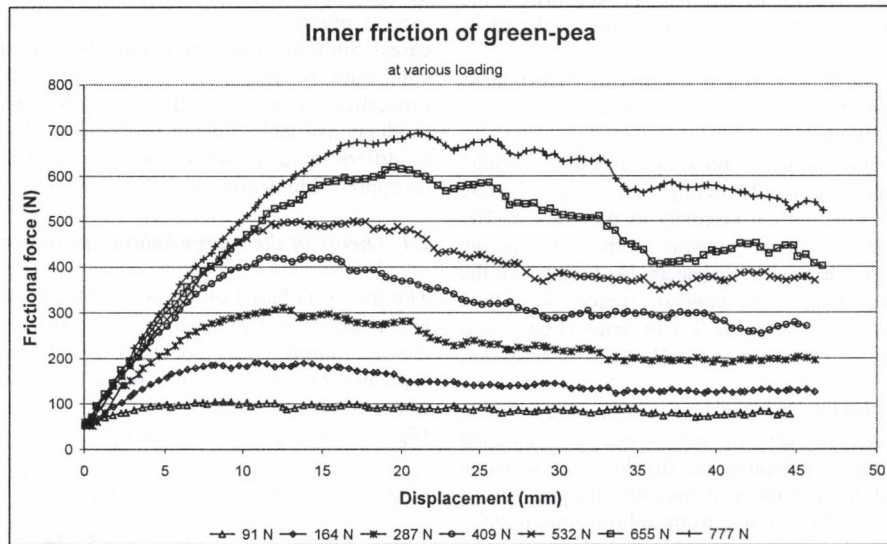

Figure 3
Relationship between frictional force and displacement by inner friction

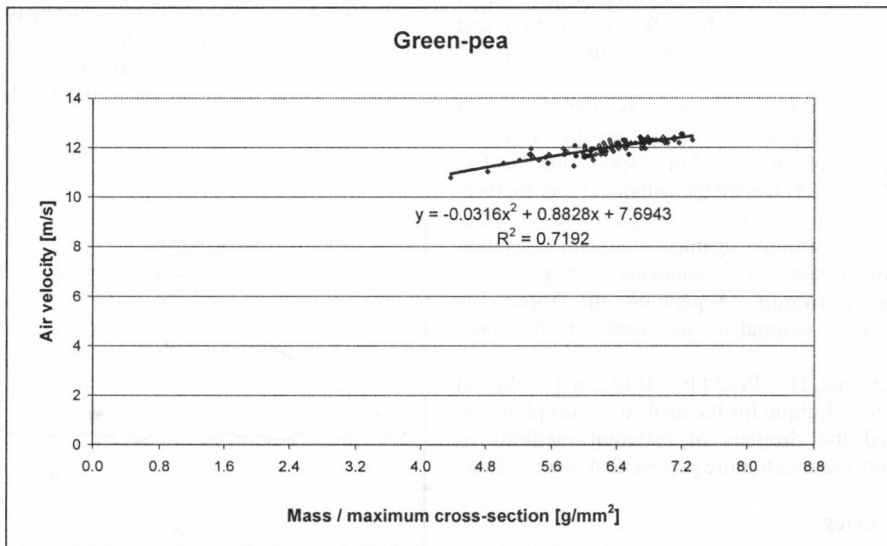

Figure 4
Relationship between air velocity and mass/maximum cross-section

THE ENERGY BALANCE METHOD OF CHARACTERIZING SPRAYS FROM HYDRAULIC NOZZLES

I. Sztachó-Pekári
College of Kecskemét

1. Introduction

During the improve of sprinkler and sprayer nozzles there have been worked out a few of theories of atomization. LITTAYE [1943] developed an equation relating drop size, to the velocity between liquid and surrounding gas, surface tension, and gas density.

FRENCH [1942] and AKENSON [1952] reported that the average drop size produced by a nozzle varies nearly as the inverse square-root of the pressure. Regarding the physical properties of the liquid and their effect, HOUGHTON [1950] stated that the average drop-size from a given nozzle is decreased if either the surface tension or density is reduced, and that it is not greatly affected by viscosity in the range from one to ten times the viscosity of water.

LANE [1951] attempted to explain atomization in an air blast by means of simplified assumption relating the dynamic drag to the surface tension. He came up with an empirical expression. This relation resembles the relation of LITTAYE [1943], where the surface tension is considered constant and relative velocity is used in the relation.

HINZE [1955] found out that the forces controlling deformation and break-up comprise two nondimensional groups: the *WEBER group*, and a *viscosity group*.

FASER [1958] gave an empirical relation describing droplet surface mean-diameter from nozzles, using the pressure, the rate of discharge, and the kinematical viscosity as parameters. The use of the nondimensional *WEBER number* at the study of the breakup mechanism give him new prospects. He found, that the breakup occurs when the *WEBER number* exceeds a critical value. With the use of *WEBER number* it is to write an empirical relation for the predicted droplet size too [LÁSZLÓ A. in SITKEI Gy. ed. 1997].

AKESON – YATES [1961] mentioned that theoretical considerations of the effect of viscosity on drop size are not very clear, and that various observers have indicated that the drop size variation with 0.2~1.0 exponent of the dynamical viscosity changes.

VÖRÖS [1935] measured droplet size from hollow-cone nozzles by means of receiving their traces on calibrated blotting paper. Resulting spray-cone angles varied according to variations in the swirl-chamber depth. Similar measurements were taken by EL-AWADY – AFIFI [1974] by means of receiving droplets in an oil bath. LÁSZLÓ [1979] analyzed the effect of internal and external forces on the droplets and have got theoretical and empirical conclusions.

AMBERG – BUTLER [1969] developed a stroboscopic high-speed photographic technique for the analysis of the formation of liquid droplets near the orifice of an agricultural spray nozzle. The excellent technique developed enabled the authors to four pictures of a droplet before escaping the camera range. Results clearly showed the liquid sheet, disruption ligamentation, and separation of droplets. Photographs show that ligaments – in general – extend laterally and outwardly. Separation of droplets is essentially caused by their internal motion relative to the spray body.

LÁSZLÓ A. – GANZELMEIER, H. – PÁLYI B. – RIETZ, S. [1998] had developed a new laser technique for the analysis of droplet-size. They have measured the droplets of different methods of atomization, the results are much more precise that were before.

2. Atomization's theories

It is seen from the above review that there is no unified theory to tie up the drop size to affecting parameters, including

pressure, spray-cone angle, and liquid properties: surface tension, viscosity, and density. The sought theory should satisfy the following conditions:

- correct dimensions;
- sound theoretical background;
- general in the sense that it includes all pertinent factors;
- applies to existing data.

Such breakup theory is needed to give estimation to droplet size in relation to affecting factors. Careful droplet size study is essential since it directly deals with such problems as:

- drift and evaporation from sprays, with the problem of hazardous pesticides gaining an even increasing inertia;
- degradation of pesticides and tolerable time after which sprayed crops can be used for food;
- effect on insects;
- coverage, penetration, and distribution on different portions of plants, soil, and air;
- spray drying;
- combustion from burners.

Application of the atomization theory includes prediction and control of drop size to meet optimum requirements. Equipment designer can take care of variations in nozzle geometry as well as spraying pressure and liquid properties. Operators can take care of pressure variation as well as liquid properties in some cases. Spraying material manufacturers supply materials that contribute to drop size control through different physical properties: viscosity, surface tension and density. Lately, products available include viscosity modifiers. Surface tension modifiers include stickers, detergents, and wetting agents. But no appreciable density modifiers are known.

2.1. Theory of the energy balance principle

The theory is based on the assumption that atomization can be explained by energy balance in a process where a small mass Δm of liquid (with no, or negligible initial free surface) separates radially from the liquid sheet into a single droplet under combined effect of viscosity, surface tension, and gravity (fig. 1). This equation is given by:

$$E_{\Delta m \text{ kin}} + E_{\Delta m \text{ pot}} = E_{\text{drop kin}} + E_{\text{drop pot}} + E_{\text{drop } \sigma} + E_{\text{drop } \mu} \quad (1)$$

- where
- $E_{\Delta m \text{ kin}}$ - is the kinetic energy of Δm when it is within the liquid sheet [J];
 - $E_{\Delta m \text{ pot}}$ - is the in potential energy of Δm before formation of the droplet [J];
 - $E_{\text{drop kin}}$ - is the kinetic energy of Δm when it has formed into a droplet [J];
 - $E_{\text{drop pot}}$ - is the potential energy of Δm after formation of the droplet [J];
 - $E_{\text{drop } \sigma}$ - is the surface energy of the droplet [J];
 - $E_{\text{drop } \mu}$ - is the energy dissipated to overcome viscosity [J].

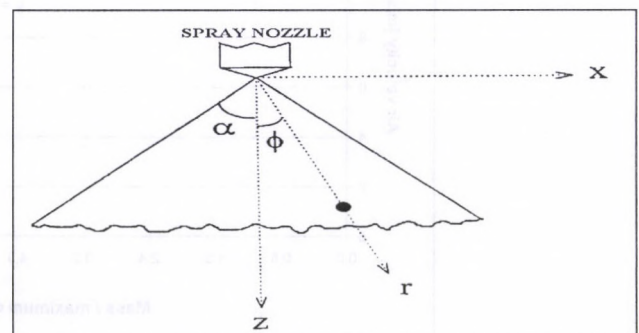

Figure 1
Spray nozzle with a symmetric spray cone envelope

Equation (1) can be written as:

$$\begin{aligned} & \frac{1}{12} \pi \cdot d^3 \cdot \rho_{liq} \cdot v_1^2 + \frac{1}{6} \pi \cdot d^3 \cdot \rho_{liq} \cdot g \cdot \Delta h = \\ & = \frac{1}{12} \pi \cdot d^3 \cdot \rho_{liq} \cdot v_2^2 + \pi \cdot d^2 \cdot \sigma + \frac{1}{4} \pi \cdot d^2 \cdot \mu \cdot v_1 \end{aligned} \quad (2)$$

where d - is the diameter of droplet [m];
 ρ_{liq} - is the density of the spray liquid [kg m⁻³];
 v_1 - is the velocity of Δm within the liquid sheet [m s⁻¹];
 g - is the acceleration of gravity [m s⁻²];
 Δh - is the vertical distance between the leading edge of the liquid sheet at breakup and the position where the droplet is formed [m];
 v_2 - is the velocity of Δm after the droplet is formed [m s⁻¹];
 σ - is the surface tension of the spray liquid [N m⁻¹];
 μ - absolute viscosity of the spray liquid [N s m⁻¹];

Equation (2) can be written as:

$$d = \frac{12\sigma + 3\mu \cdot v_1}{\rho_{liq}(v_1^2 + 2g\Delta h - v_2^2)} \quad (3)$$

The lower limit for the minimum diameter D_{min} (d at $v_2=0$) along a radial line is given by:

$$D_{min} = \frac{12\sigma + 3\mu \cdot v_1}{\rho_{liq}(v_1^2 + 2g\Delta h)} \quad (4)$$

Similarly, the upper limit for the maximum diameter D_{max} (d at $v_2=v_1$) along a radial line is given by:

$$D_{max} = \frac{12\sigma + 3\mu \cdot v_1}{2\rho_{liq} g\Delta h} \quad (5)$$

The above energy balance equation (1) can be improved to account for the effect of ambient air during a drop separation process, namely viscous drag, air entrainment, drop turbulence, and mutual interference of droplets. The effective-drag force F_{Cw} acting on a droplet separating along a radial line from a liquid sheet can be estimated by:

$$F_{Cw} = \frac{1}{2} \rho_{air} \cdot C_w \cdot A \cdot (v_{liq} - v_{air})^2 \quad (6)$$

where ρ_{air} - is the density of the ambient air [kg m⁻³];
 C_w - is the effective-drag coefficient [];
 A - is the projected area of the droplet [m²];
 v_{liq} - is the velocity of the spray liquid [kg m⁻³];
 v_{air} - is the velocity of the air [m s⁻¹].

The effective drag coefficient is given by the following equation [SIDAHMED 1997]:

$$C_w = k \left(1 - \frac{D_{min}}{d} \right)^n \quad (7)$$

where $n \geq 0$, k - is constant parameter [].

Substituting equations (3) and (4) in equation (7) and since $2h \ll v_1^2$ [SIDAHMED, 1998], we obtain:

$$C_w = k \left(\frac{v_2}{v_1} \right)^{2n} \quad (8)$$

The relative velocity $(v_{liq} - v_{air})$ in equation (6) can be approximated by the average velocity of the liquid sheet v_1 and v_2 [SIDAHMED, 1998]:

$$v_{liq} - v_{air} = \frac{v_1 + v_2}{2} \quad (9)$$

From the equations (6), (7), (8), and (9) the energy-drag energy:

$$E_{Cw} = F_{Cw} \cdot \Delta r = \frac{1}{32} \pi \cdot d^2 \cdot \rho_{air} \cdot k \left(\frac{v_2}{v_1} \right)^{2n} (v_1 + v_2)^2 \cdot \Delta r \quad (10)$$

where Δr - is the radial distance between the leading edge of the liquid sheet at breakup and the position where the droplet is formed (fig. 1) [m].

Equation (1) can also be modified to calculate the energy dissipated by viscosity. The shear energy $E_{drop \mu}$ in terms of a characteristic velocity $(v_1 - v_2)$ equivalent to the change in the velocity of Δm during the separation from the liquid sheet and subsequent formation into a droplet, instead of v_1 [SIDAHMED, 1998]. Thus, $E_{drop \mu}$ becomes:

$$E_{drop \mu} = \frac{1}{4} \pi \cdot d^2 \cdot \mu (v_1 - v_2) \quad (11)$$

Note that since $v_2 \leq v_1$, then $E_{drop \mu} \leq \frac{1}{4} \pi \cdot d^2 \cdot \mu \cdot v_1 / 4$, which

means while the effect of viscosity in equation (2) is overestimated for larger droplets, its effect for typical sprays is negligible.

When the effective-drag energy E_{Cw} in eq. (10) and the modified shear energy $E_{drop \mu}$ in eq. (11) are included in the energy balance eq. (1), the droplet size becomes:

$$d = \frac{12\sigma + 3\mu(v_1 - v_2) + 0,375\rho_{air} \cdot k \left(\frac{v_2}{v_1} \right)^{2n} \cdot (v_1 + v_2)^2 \Delta r}{\rho_{liq}(v_1^2 + 2g\Delta h - v_2^2)} \quad (12)$$

Accordingly, at $d=D_{min}$ (d at $v_2 = 0$) eq. (12) reduces to eq. (4), and D_{max} (d at $v_2=v_1$) along a radial line is given by:

$$D_{max} = \frac{12\sigma + 1,5\rho_{air} \cdot k \cdot v_1^2 \cdot \Delta r}{2\rho_{liq} \cdot g\Delta h} \quad (13)$$

3. Supervision of the theoretical equations

Fig. 2 shows the effective-drag (for $\Delta r=0d - 25d$) on velocities eq. (12) of droplets emitted along the axis ($\Phi=0$ or $\Delta h=\Delta r$). Of a water spray ($\sigma=73 \cdot 10^{-3} \text{ N m}^{-1}$; $\mu=1,01 \cdot 10^{-3} \text{ N s m}^{-2}$; $\rho_{liq}=10^3 \text{ kg m}^{-3}$) in still air ($\rho_{air}=1,26 \text{ kg m}^{-3}$), assuming $v_{air}=17,93 \text{ m s}^{-1}$, $k=0,67$; $n=3,5$ [SIDAHMED, 1997].

Calculations were carried up to $3 \mu\text{m} \div 500 \mu\text{m}$ drops. As seen on fig. 2, drop velocities were not conspicuous by effective-drag when Δr varied from $0d - 25d$. However, the difference between the velocity of the liquid sheet (at breakup) and the velocity of the largest droplet increased slightly with Δr . Thus, the effect of the effective-drag during separation of liquid mass (Δm) and its subsequent formation into a drop can be neglected for water sprays in still air.

It is worthwhile to mention that drop velocities that are extremely close to the liquid sheet velocity can yield unrealistic large drop size [eq. (13)]. This means that such remarkably

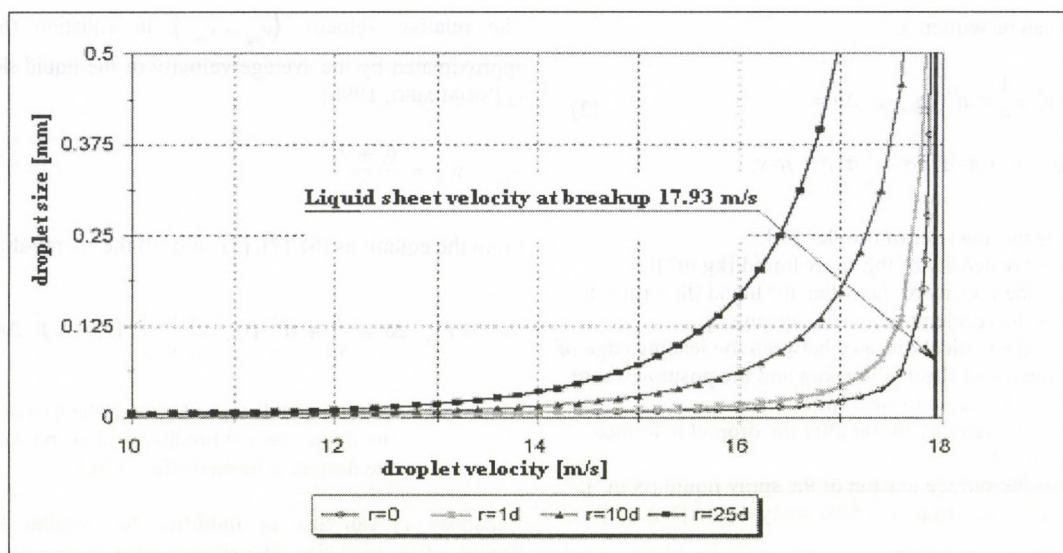

Figure 2
Calculated effect of effective drag on velocities of droplets

close velocities (which meanly represent drop formation by gravity) are very unlikely to occur in real sprays.

4. Conclusions

Drop-size/velocity correlation equations were developed based on the energy balance method, assuming that a droplet separates (from liquid sheet) radially under the combined effect of viscosity (μ), surface tension (σ) gravity (g), and effective-drag. The effective drag was assumed to account for the effects of viscous drag, air entrainment, and mutual interference of droplets in a spray.

Analysis of equations revealed that:

- Compatibility of the energy balance equations requires that drop separation be completed at a radial distance (from the liquid sheet breakup region) equal to the droplet diameter. This requirement is automatically relaxed in the energy balance equation.

- The calculated effect of effective-drag (for $\Delta r=0d - 25d$) on drop velocities was negligible for a water spray in still air.

By this theory not explainable further phenomenon at the drop separation will be investigated of the force balance of the acting forces of the small mass Δm of liquid.

5. References

- [1] AKESSON, N. B. – YATES, W. E. 1962: Application aspects of viscous emulsions as an agricultural spray formulation. ASAE Paper No. 61-617, St. Joseph, Mich.: ASAE
- [2] AMBERG, A. A. – BUTLER, B. J. 1969: High speed photography as a tool for spray droplet analysis. ASAE Paper No. 69-140. St. Joseph, Mich.: ASAE
- [3] EL-AWADY, M. N. – AFIFI, F. A. 1974: Spraying boom and nozzle modifications for improved application on cotton plants. Annals of Ag. Sc., Faculty of Ag., Ain-Shams U., Cairo, Egypt.
- [4] FRENCH, O. C. 1942: Spraying equipment for pest control, cal. Ag. Exp. St. Bul. 666.
- [5] HINZE, J. O. 1955: Fundamentals of hydrodynamic mechanism of splitting in dispersion processes, Am Inst. Of Chem. Engrs.
- [6] HOUGHTON, H. G. 1950: Spray nozzles, Chem. Engrs. Handbook, ed. J. Perry, McGraw-Hill: 1170-1175 p.
- [7] LANE, W. R. 1951: Shatter of drops in streams of air, Indust. And Engg. Chem., 43. sz. 1312-1317 p.
- [8] LÁSZLÓ A. 1979: A hidraulikus cseppképzés néhány áramlástanai problémájának vizsgálata, különös tekintettel a cirkulációs szórófejekre. ATEK, Keszthelyi Mg. Kar Közleményei, Keszthely, XXI. k. 4. sz.28 p.
- [9] LÁSZLÓ A. in SITKEI GY. ed. 1997: Gyakorlati Áramlástan. Mg. Szaktudás Kiadó, Budapest. 393-418 p.
- [10] LÁSZLÓ A. – GANZELMEIER, H. – PÁLYI B. – RIETZ, S. 1998: Cseppképzési és elsodródási összefüggések vizsgálata német-magyar kutatási együttműködés keretében. XL. Georgikon Napok, Keszthely, Különkiadvány III. k. 246-250 p.
- [11] LITTAYE, G. 1943: Sur l'atomization d'un jet liquide, Compt. Rend., Oct. 215, 340-342 p.
- [12] SIDAHMED, M. M. 1997: Transport model for near nozzle fan sprays. Transaction of the ASAE. 40.k. 3. sz. 547-554 p.
- [13] SIDAHMED, M. M. 1998: Analytical comparison of force and energy balance methods for characterizing sprays from hydraulic nozzles. Transaction of the ASAE. 41.k. 3. sz. 531-536 p.
- [14] VÖRÖS I. 1935: A cirkuláció és a kapilláris erők szerepe a cseppképzésben permetező szórófejeknél. Diss. M. Kir. József Nádor Műegyetem, 53p.
- [15] YOUNIS, S. M. 1969: Development of modified knapsack sprayer for effective control of cotton pests, M.S. Thesis in Ag. Engg., U. Alex., Egypt.

ALTERNATIVES OF THE DOMESTIC AGRICULTURAL MACHINERY MARKET

J. Hajdú – L. Magó

Hungarian Institute of Agricultural Engineering, Gödöllő

The development requirements of the mechanisation of the Hungarian agriculture

In order to meet the requirements of the ecology and the market, the Hungarian agriculture needs technical and technological renewal. This requires a smooth and balanced agricultural machinery market, which takes the needs of both the farmers' and farms' needs into consideration extensively. The Hungarian agriculture's coverage with engine power is 1.8 kW/hectare. The density of tractors and combine harvesters is low. 48.8 hectares of land has to be cropped by 1 tractor, 1 combine harvester has to cover the area of 276 hectares. Compared on an international level, these figures indicate a very low level of coverage; they need to be increased.

The tasks of developing the mechanisation of Hungarian agriculture are dual:

- The improvement of coverage of agricultural machinery, and the increase of their density. The establishment of such machinery output which is capable of meeting the demands of the new structures of technology and property. This makes the increase of machine coverage essential, especially in the family-owned farms.
- The replacement of amortised and overused machines with new ones. The meeting of the demands of the technological modernisation.

The supply of the market of agricultural machinery must facilitate the realisation of these development objectives in such a way that it offers a both technically and financially suitable range for the farms willing to invest.

The group of those willing to purchase agricultural machinery

The Hungarian statistics have a record of 958 thousand persons possessing land and pursuing agricultural activities. 70 % of these use an area of land not exceeding 1 hectare. Their need for mechanisation is minimal, and thus they could be put into the category of hobby. The farms possessing an area between 1-10 hectares only have a partial need for mechanisation also. From the point of mechanisation those 56 thousand farms should be taken into consideration, which possess an area exceeding 10 hectares, among them special attention should be paid to those 4800 farms whose land exceeds 100 hectares.

51.7 % of the agricultural land is used by individual farms (self-employed or small home producers), their average size is 4.05 hectare/farm.

32.2 % of the agricultural land is used by firms (limited companies, partnerships, etc) and 15.1 % of the land is used by co-operatives. The average size of land of the former is 582.4 hectare, while that of the latter is 1226.9 hectare.

43.2 % of the investment into machinery was realised by individual farms, 46.6 % by firms and 9.5 by co-operatives.

Due to the process of the concentration of properties, it is expected that the number of the farms will fall, and the purchasing power of the companies will grow.

The group of those selling agricultural machinery

813 dealers are registered in the catalogue of machinery annually compiled by our institution. They range from importers with a national dealer network, manufacturers selling their own products, distributors covering a certain region and other enterprises specialised in a particular range of products.

The bulk of the dealers is made up of small enterprises with little capital. 22 % of the dealers are medium-sized businesses with their own substantial clienteles, offering services as well as products. 6 % of the dealers may be regarded as a major enterprise with modern facilities, and customer service.

60 % of the total turnover is realised by 12-15 dealers, which have a countrywide sales network.

The dealers cover the whole country geographically, and are easily accessible.

The current structure of dealer network is expected to change. Due to concentration of capital, the number of major units belonging to a particular network and offering better services is expected to grow.

The agricultural machinery market supply

The Hungarian agricultural machinery supply offers 55 800 types and variants of machinery from 1 900 manufacturers. The offer of tractors includes 1350 tractor types and their variants from 58 manufacturers (19 Eastern European and 39 Western European). The range of cereal combine harvesters includes 252 different types and their variants from 10 manufacturers (3 Eastern European and 7 Western European). We can find 1815 types of ploughs and 1872 seeding machines on the market. The number of spraying machines is even higher, 2664 types and variants are on offer. 44 manufacturers offer 882 types of mowing-machines. There are more than 1000 types of cereal driers available. The number of types and variants of milking-machines exceeds 640.

These figures demonstrate that most of the world's agricultural machinery manufacturers are present on the Hungarian market.

Investment in agricultural machinery, the sales of machines

In recent years the Hungarian farms bought agricultural machinery to the value of HUF 43 to 104 billion (€178 to 369 million). Investments in machinery reached a negative record in the early 1990s, but they gained momentum and gradually increased after the middle of the decade. Apart from certain years, there was a dynamic growth. This was encouraged by the lack of machinery following the structural changes on agriculture and the need for modernisation, and was catalysed by government subventions. As a result of purchases of machinery, there were 70 to 130 thousand new machines put into operation every year. The number of farms investing in new machinery exceeded 30 to 35 thousand annually.

The largest part, 42 to 43 % of the financial resources used for purchasing machinery, was made up of the farms' own liquid resources. The rate of bank loans and leasing was 29 to 31 %, while that of government subvention made up 25 to 27 %.

The largest value of investments was made up by tractors and automotive harvesters (cereal combine harvesters). 54 to 58 % of the resources was used for purchasing these machines. The remaining part was used for purchasing farm implements, irrigation systems, fodder processing machines, materials-handling equipment, equipment for animal husbandry.

Over 80 % of the purchased machines was for crop production, machinery for animal husbandry made up 7 to 8 %, while the remaining 11 to 22 % is made up by the other divisions.

13.8 % of the value of the machines purchased by agriculture was manufactured in Hungary, 69.7 % was imported from the West. If the number of machines is considered, these proportions are slightly different. The share of the Hungarian-made machines is 28.5 %, Eastern Europeans make up 4.3 %, whereas the Western manufacturers' share is 67.2 %. Over a ten year period the farms purchased annually 3091 tractors. However, this varied from 1732 to 596 tractors / year.

This annually purchased quantity makes up only 2.7 % of the Hungarian fleet of tractors. If we regard the technical condition

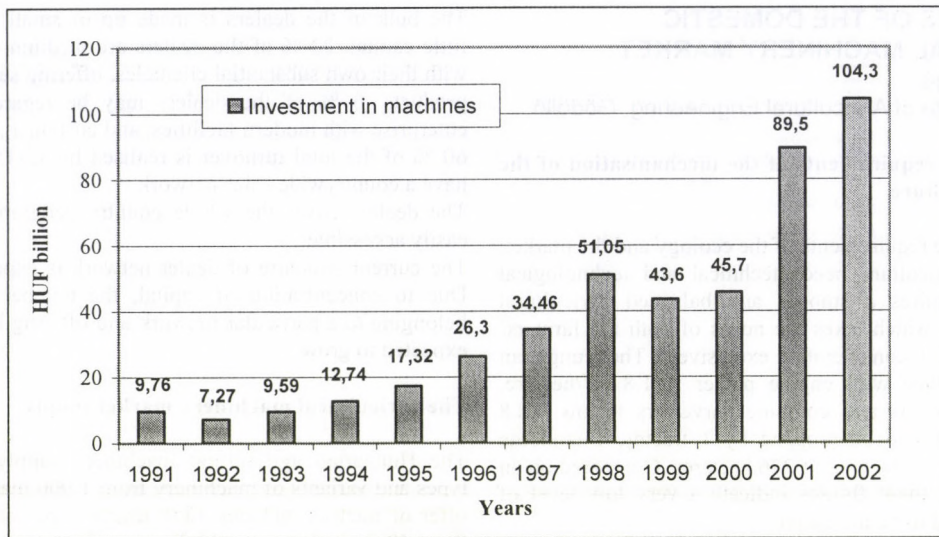

Figure 1
Investment in agricultural machinery – nominal value 1991- 2002 [1 € = 260 HUF]

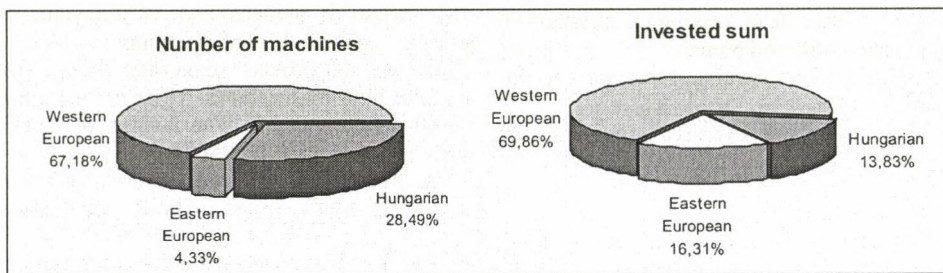

Figure 2
The distribution of invested machinery according to origin

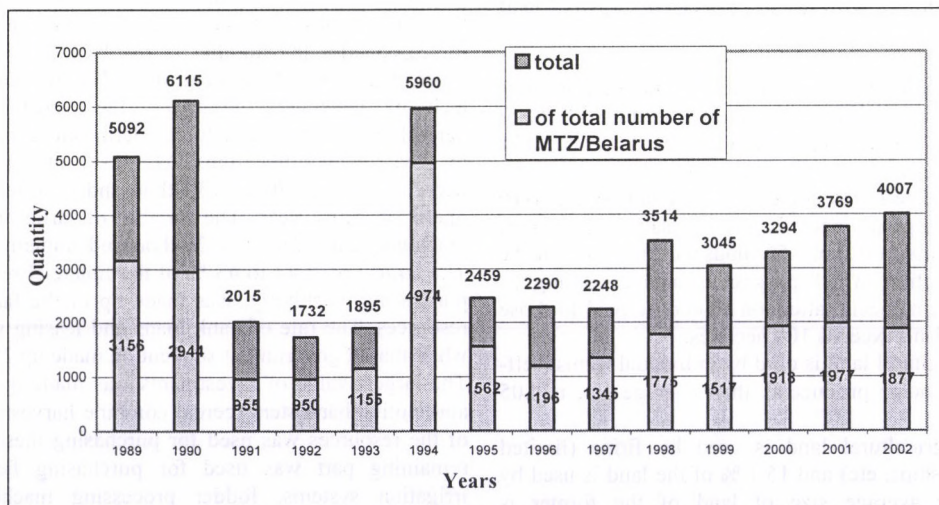

Figure 3
Tractor sales in Hungary (1989 - 2002)

of the Hungarian fleet, the agriculture should double its present investment in order to make the tractor capacity sensibly improve, and to increase the density of tractors. The bulk of the purchased tractors – over 75 % - belong to the category whose performance does not exceed 100 HP.

The yearly sales list of tractors is topped by MTZ/Belarus, accounting for over 50 % of the totals tractor sales. 70% of the annually sold tractors are made up of Eastern European tractors, the remaining 30 % is shared by Western manufacturers, New Holland, John Deere, Case-IH, etc.

The annual sales of cereal combine harvesters fluctuates greatly. If we take the last ten years for the basis of average, annually 317 cereal combine harvesters were sold, which is 2.6% of the current fleet. Most of the purchased machines belonged to the category exceeding the capacity of 10 kg/sec. New Holland, Claas and John Deere accounted for the bulk of the sales.

The Hungarian agriculture purchased annually 4300 to 5800 tillage machines, mostly from Hungarian manufacturers. The number of annually sold seeding machines ranged from 1260, of which 35 to 40% was made up of row seeders and disc

seeders. Most of the seeding machines for spiciferous cereals was manufactured in Western Europe, whereas the seed-spacing drills were mostly made in Eastern Europe.

In recent years Hungarian farms purchased 600 to 1070 fertiliser units, 1000 to 1700 spraying machines. The sales of fertiliser units were dominated by Western European (Italian), whereas that of the sprayers were dominated by Hungarian and other Eastern European models.

The market of irrigation systems is really slim, the farmers purchase 36 to 126 machines annually. The models with which the hose could be wound on a drum were preferred, prevalently from Western European manufacturers. Among coarse fodder crop harvesters 324 to 590 mowers were annually sold, with an average of 490 machines/year. The number of sold baler varied between 180 and 310 machines annually, most of which were rotary balers. The proportion of the sales of the Hungarian-made machines is high in both product ranges. The Hungarian agriculture purchases annually 340 to 500 trailers, mostly the products of Hungarian manufacturers.

Equipment for animal husbandry was sold to the value of HUF 3.6 to 6.4 billion in recent years in Hungary. Out of this 40 to 43% was used in poultry farming, 25 to 26% in cattle farming and 23 to 24% was used in pig farming. The remaining 7 to 8% was used in other animal divisions.

The turnover of the sales of agricultural machinery in Hungary makes up at most 1.0 to 1.5% of the world's total output, so it is not really substantial. However, for us this market is still very important in order to secure a supply facilitating the technical renewal of the agriculture. We hope that the most important figures of the world market will consider their Hungarian customers and they will enhance the Hungarian market supply with their presence.

Hungarian agriculture would like to lay a special emphasis on the products of the European agricultural machinery producers.

References

- [1] **Hajdú J.:** (1991) „Effect of Change of the Farm Structure on the Mechanization”, Hungarian Agricultural Engineering, No 4., p. 29-30.
- [2] **Hajdú J., Peszeki Z., Takács I.:** (1996) „Evaluating the Technical Production Capacity of Agriculture”, Hungarian Agricultural Engineering, No 9., p. 56-57.
- [3] **Hajdú J., Magó L.:** (2003) „Characterization of the Mechanization of the Agriculture Following the Years of the Economical Change on the Basis of Hungarian Experiences”, 8th. Scientific Session of Technicians, Cluj Napoca, Romania, 21-22. Marc 2003. p. 177-180.
- [4] **Husti I.:** (2002) „New Problems and Possibilities in the Technical Development of the Hungarian Agriculture”, Innovation in the Agriculture and the Industry, International Conference on Agricultural Engineering Abstracts, Budapest, 30 June -4. July 2002. Vol. 1. p. 276-277.
- [5] **Magó L.:** (2002) „Selection of the Machinery Fleet by Integer Non-linear Programming”, Innovation in the Agriculture and the Industry, International Conference on Agricultural Engineering Abstracts, Budapest, 30 June -4. July 2002. Vol. 2. p. 112-113.
- [6] **Magó L., Hajdú J.:** (2003) „Utilization Cost Structure of Optimal Power Machinery Fleets According to the Farm Sizes”, Proceedings of the 31th International Symposium “Actual Tasks on Agricultural Engineering”, Opatija, Croatia, 24-28. February 2003. Proc. p. 143-150.

CHANGES IN SOME INDICES OF CAPITAL EFFICIENCY OF FARMS, SPECIALITY OF REGIONS

I. Takács

Szent István University, Gödöllő

Introduction

The economic-social transition in Hungary in the nineties – although in a different way but mainly negatively – changed the economic way of thinking of agricultural producers. Most of those dealing with agriculture used to focus on efficient production but by now they have changed their minds and concentrate on social concerns, thus the resources for production are not operated economically. Every government after the transition – although focusing on different social groups – tried to get the votes of the politically very important rural population – living partly or fully from agricultural income – by trying to improve the situation of the high number of new owners who obtained their land after the – conceptually wrong – privatization of the property of agricultural cooperatives. As a result, there are no efforts made to increase the efficiency of the capital injected into the economy through income subsidies, the tax system and other subsidies which are used for improving the financial situation of farmers. The effects of the above-mentioned factors are investigated by using the figures for asset efficiency of farms.

The assets of large scale enterprises which had been developed in the 1970's and 1980's was not suitable for efficiently and economically supplying the new size of enterprises and new plot sizes. Machines for large plot production could only be used for much smaller plots with a very significant decrease in efficiency. In the nineties asset investments could not reach their former figures on a real level therefore the increase in assets stock was not able to satisfy the extra capacity need which originates from the ageing away of assets and a change in production structure. As a consequence of the increase in capacity need, technically aged and used machines are still in operation. Then as a result of the two effects machines are getting aged. [Hajdú et al., 1996] [A mezőgazdaság gép- és épületállománya 1991-2000.]

Only a small proportion individual farms (which are mainly micro and small holdings) own machines therefore they need to hire entrepreneurs and draw on their services. This is a rational decision from an economical point of view but those who own machines can only operate them at a low efficiency which results in a rise in unit costs of operating machines.

If only tractor supply is taken into account, every tenth private farmer owns a tractor. [Agriculture in Hungary, 2000] The figures are very similar in the case of other types of assets. Of course, it is not recommended that every small farm should own the whole range of assets for production but the data shows that the shortage of capital is very high.

Based on the above-mentioned facts the competitiveness of Hungarian agriculture depends on whether its technical development can be implemented or not, or whether the forms of cooperation and organizational solutions which are necessary for providing the efficiency of the capital fixed in asset stock, can be successfully developed and operated or not.

This paper tries to answer the questions as follows:

- What are the attributes of capital efficiency of farms?
- What are the differences between the technical supply of the regions in Hungary?

To answer the questions some regional data on the balance of capacity of the main agricultural machines are presented to analyze the regional differences. Statistical analyses show that the technical supply of private farms seems to be crucial, thus

the paper – based on the farm data in the Central Hungarian region – tries to give an overview on the asset supply of private farms which produce for the market and the efficiency of capital fixed in assets.

It is also important – from the aspect of the technical development concept – to determine which sphere of farms should the resources necessary for technical supply be concentrated on.

Material and method

The basis for the analyses of agricultural enterprises in this paper is provided by the data having been collected for years by the Research and Information Institute for Agricultural Economics (AKII). In 1999 the AKII carried out investigations on 1300 farms and 1670 in 2000. They frequently reported on the results of their investigations [Kovács G. and Keszthelyi Sz., 2000], [Keszthelyi Sz. and Kovács G., 2002]. Their results show that the income situation of agricultural enterprises is different. The profitability of agriculturists and sole proprietorships is usually higher than that of businesses – mainly cooperatives – but the volume of the value of production by most of the small enterprises is not sufficient to produce an amount of profit in order to provide for a family.

The general definition for efficiency is: the maximum possible yield by using one unit of a given resource. The gross value of production (realized sales revenue) was used for measuring capital efficiency; the amount of labour used (in unit of labour), materialised labour (material expenditures and depreciation), and the value of fixed assets and inventories were considered as expenditures. The data origins from balance sheets and profit and loss accounts of the farms in the Farm Accountancy Data Network.

During the evaluation of the results the most important changes for a two year period according to types of enterprises and statistical regions were examined.

Results

Investigating the capital efficiency of farms per the natural unit of the available resources, it is clear that most of Hungarian small farms operate at a lower level of asset efficiency than large farms. [Takács I. – Kovács G., 2002.] At the same time during the privatization after the transformation these large enterprises obtained used and amortized assets, furthermore in the 1990's investment activity focused on supplying the capacity needs of enterprises by cheap and less modern assets. The unit – per capacity unit – value of capital of assets was lower than that of more modern and high value assets. However this could be considered as favourable from the aspect of capital efficiency. The question is whether this amount of fixed capital is sufficient to provide the necessary capital efficiency or not.

However examining the attributes and the direction of change of the capital efficiency of agricultural enterprises the expectation – which assumed that the lower value of capital fixed in assets compensate the lower value for asset use and therefore claims the capital efficiency of small farms is acceptable – is not proved to be correct.

From the aspect of production the durably fixed capital which serves the operation of agricultural enterprises is represented mainly by fixed assets while temporarily available capital is mainly represented by inventories. Investigating fixed asset turnover and inventory turnover (Table 1) the figures for private farms are characteristically lower than those for businesses. The asset turnover of private farms was between 0.84 and 0.89 while for businesses – including types of enterprises which are not included in the table – it is between 1.75 and 2.78. If we also take into account that the amount of fixed capital in private

farms is only one tenth or twentieth of that of corporate farms the problem of efficiency is definitely clear.

Investigating inventory efficiency I found that the situation is a bit more favourable: inventory turnover is more balanced. The figures are between 2.5 and 3.0 which are the usual figures characteristic to agriculture. The average value for inventories of businesses is 30-50 times higher than that of private farms.

The efficiency of labour use is more favourable in unlimited liability partnerships and limited partnerships. The gross value of production produced by one unit of labour (UoL) exceeded 9300 thousand HUF in 2000. The efficiency of labour increased in every type of enterprise.

Investigating cost efficiency the situation is also balanced.

Evaluating capital efficiency by regions the data shows that the average efficiency of farms in the Transdanubian and South Hungarian regions is higher than that of Central, East and North Hungary. In terms of indicators for efficiency the Northern Hungarian region is in the worst situation where the figures are the worst in every category except cost efficiency.

Assesment of results, suggestion

The efficiency problems of Hungarian agricultural enterprises mean a significant disadvantage of competitiveness. In addition to asset efficiency the efficiency of capital fixed in farms also has to be taken into account. By applying the figures suitable for measuring capital efficiency it is clear that small farms also have problems with capital efficiency in addition to their problems with asset efficiency. The efficiency of fixed assets is significantly lower than the average of our country's economy and even lower for businesses.

Taking benefit form forms of cooperations could be a possible method for improving capital efficiency. Instead of working out technical development methods for private and small farms the development plans should concentrate on supporting the different types of cooperations.

In addition to associations for obtaining machines, machine cooperatives and links technical supply based on hired

entrepreneurs is also very important. At the same time technical development should focus on modern technology and high performance assets.

References

- [1] A mezőgazdaság gép- és épületállománya 1991-2000. Készítette Bóday Pál. Központi Statisztikai Hivatal. Budapest. 2001. 87 p.
- [2] Hajdú J. - Peszeki Z. - Takács I. (1996a) A mezőgazdaság műszaki-termelő kapacitásának értékelései. = MTA Agrár-Műszaki Bizottság Kutatási és Fejlesztési Tanácskozás. Gödöllő, 1996. 1. kötet. 230-233. p.
- [3] Hajdú J. - Takács I. - Peszeki Z. (1996b) MFA támogatással megvalósult beruházások értékelése. = MTA Agrár-Műszaki Bizottság Kutatási és Fejlesztési Tanácskozás. Gödöllő, 1996. 1. kötet. 201-206. p.
- [4] Keszthelyi Sz.- Kovács G(ábor) (2002) A tesztüzemek 2001. évi gazdálkodásának eredményei. Agrárgazdasági Információk. AKII. Budapest. 2002. 2. 123 p.
- [5] Kovács G(ábor) – Keszthelyi Sz. (2000) A tesztüzemek 1999. évi gazdálkodásának eredményei. Agrárgazdasági Információk. AKII. Budapest. 2000. 3.
- [6] Kovács G(ergely) – Takács I. (2002) A mezőgazdasági vállalkozások pénzügyi helyzetének alakulását befolyásoló tényezők vizsgálata három közép-magyarországi megyében. MTA-AMB XXVI. Kutatási és fejlesztési tanácskozás. Gödöllő. 2002. január 15-16. Konferencia kiadvány. I. kötet 174-178. p.
- [7] Magyarország mezőgazdasága a 2000. évben – területi adatok – (Agriculture in Hungary, 2000. – regional data –). Szerk.: Pintér László. Központi Statisztikai Hivatal. Budapest. 2000. 582 p.
- [8] Takács I. – Kovács G(ergely): Az egyéni gazdaságok teherhatékonyságának alakulása a közép-magyarországi térségben. XXIX. Óvári Tudományos Napok. Agrártermelés – életminőség. Mosonmagyaróvár. 2002. október 3-4. 5 p.

Table 1 Indicators for efficiency – and their changes compared to the previous year – in 2000 based on the FADN of the AKII according to type of businesses

Type of business	Number of samples (pieces)	Fixed asset turnover	Inventory turnover	Efficiency of labour use (1000 Ft/UoL)	Efficiency of operation costs	Efficiency of materialised labour
Altogether	1670	1.85	2.77	6437.97	1.06	1.47
Agriculturists	731	0.89	2.63	4082.09	1.20	1.51
Sole proprietorships	555	0.84	2.75	7170.42	1.19	1.42
Limited partnerships	111	1.95	2.77	9301.46	1.05	1.40
Cooperatives	123	2.78	2.90	5717.25	1.03	1.51
Relative change compared to 1999 (%)						
Altogether	29.0	4.4	-6.7	20.4	2.2	2.0
Agriculturists	23.1	10.0	17.6	32.1	2.8	3.3
Sole proprietorships	28.2	8.9	-0.7	16.9	-0.5	1.6
Limited partnerships	22.0	-17.1	-21.8	5.5	-1.2	1.6
Cooperatives	25.5	14.5	-0.2	27.7	3.7	-0.1

Table 2 Indicators for efficiency – and their changes compared to the previous year – in 2000 based on the FADN of the AKII according to statistical regions

Region	Number of samples (pieces)	Fixed asset turnover	Inventory turnover	Efficiency of labour use (1000 Ft/UoL)	Efficiency of operation costs	Efficiency of materialised labour
South Transdanubia	251	2.39	2.78	7549.84	1.09	1.47
West Transdanubia	269	1.51	2.67	6730.40	1.08	1.56
Central Transdanubia	174	1.98	2.77	6091.82	1.06	1.49
Central Hungary	127	1.52	2.54	5991.45	1.06	1.44
North Hungary	261	1.41	2.25	4649.96	1.04	1.54
North Great Plain	352	1.65	3.11	6666.66	1.06	1.41
South Great Plain	236	2.67	3.22	7418.53	1.04	1.46
Altogether	1670	1.85	2.77	6437.97	1.06	1.47
Relative change compared to 1999 (%)						
South Transdanubia	5.5	4.1	-2.6	32.5	5.5	2.5
West Transdanubia	2.7	5.8	-2.8	33.4	3.3	4.1
Central Transdanubia	83.2	14.0	-15.2	8.4	-0.4	-0.5
Central Hungary	0.0	-10.3	1.6	1.7	-0.1	0.8
North Hungary	137.3	-9.1	-35.6	1.7	0.5	6.6
North Great Plain	46.7	24.0	-0.7	47.6	0.7	-1.5
South Great Plain	5.8	13.6	-0.2	22.6	2.2	1.3
Altogether	29.0	4.4	-6.7	20.4	2.2	2.0

WASTE MANAGEMENT IN THE WOOD PRODUCT INDUSTRY

M. Varga – G. Németh

University of West Hungary, Sopron

1. Introduction

Clarifications of some strategic, fundamental conceptions are required prior to the discussion of waste management in the wood production industry. One of the most significant issues is to clarify the notion of waste. According to the definition of KELLER (1997) the notion of waste means nothing but „raw material not at a suitable place“. According to the Act.XLIII.2000: waste can be anything defined as in the 1.Amendment of the Act.XLIII.2000 the category of waste can be outlined as an object or material, which has been rejected by its owner or it is to be thrown away or it must be thrown away“. It is also important to highlight the question of the increasing risks of hazardous substances. It is defined in the act as follows: a material is to be understood as a hazardous substance if it contains one or more properties as listed in 2.Amendment or its origin, composition, concentration endanger human health or environment.” That is why definition of the fact whether a particular waste is hazardous or not is only a secondary decision. First clarification of the fact whether the material is a waste or not should be determined.

A further clarification of the notion of waste is required being relevant to wood industry.

In the course of the production of the centre product, rising of certain by-products is unavoidable. (Edgings, particles, sawdust etc.) These by-products – in that particular production procedure or in other one should be regarded as initial materials or raw materials representing full value. This sort of centre product attitude- (being prodigal but dominant) focused product management must be cancelled. Raw material prices, energy prices but first of all risks of environmental pollution call for the launching or adoption of new technologies to reduce unfavourable waste.

Generally the originating by-products cannot be replaced into the original production procedure but professional product management can settle the condition of replacement of the by-product to another production procedure as a raw material representing full value.

(An excellent example is the utilization of wood- based by-product materials available in a huge quantity.) Further utilization of by-products can also be justified since management, treatment and destruction of waste materials is very expensive.

2. Guidelines of waste management

Waste management can be defined as a deliberate human activity to take certain precautionary measures to reduce or eliminate originating waste materials, and to take all possible measures to utilize the unavoidably originating waste materials. Further management and environmentally friendly waste disposal of the residual waste is required. [2.]

The most important objective is to reduce the quantity of the utilized raw materials and the originating waste materials as well. The unavoidably originating waste materials should be partly or totally recycled. The residual waste materials should be treated and professionally allocated.

2.1. The most important aspects of waste management in the wood industry

- Reduction of energy and raw material consumption, increment of the efficiency of utilization

- Reduction of the quantity of waste materials, adoption of natural resource efficiency policy, minimizing loading of wastes in environment, minimizing pollution, prevention of pollution with minimizing originating of waste materials (the possible most efficient utilization of natural materials, creating long lasting and recycle-able products.)
- Reduction of the quantity of the waste materials, reduction the hazard of the wastes'
- Efficient utilization of the originating waste, waste should be involved in the production-consumption circulation, environmentally friendly waste disposal of the non-recycle-able waste.
- Reduction of loading of waste on human health, natural and artificial environment.

2.2. Treatment of wood industrial waste



Figure 1
Priority of wood industrial waste treatment [5]

There are several methods available of waste management and treatment of wood industrial waste. The sequence and priority of the possible procedures can be modelled as shown in figure 1.

The treatment of wood industrial waste is designed to produce the least possible quantity of waste. It means that minimizing the originating waste is to be supported. That particular part of the raw material, which is about to become waste costs a lot that is why it should not be regarded as a value to be written off. On the other hand collecting, transporting, storing and disposal waste is also very expensive, representing significant losses. That is why launching environmentally friendly technologies is indispensable.

So as to prevent originating waste, to reduce its quantity and to eliminate its hazard the following factors should be taken into consideration:

- Application of energy efficient and raw material efficient technologies, minimizing originating waste
- Involvement of raw material in production – consumption circulation
- Manufacturing products with the outcome of the waste material in the possible least volume and mass, posing no environmental risk
- Selecting the raw material being non- hazardous substances

2.2.1. Prevention and reduction of originating wood industrial waste

The procedure of prevention consists of two significant strategic components:

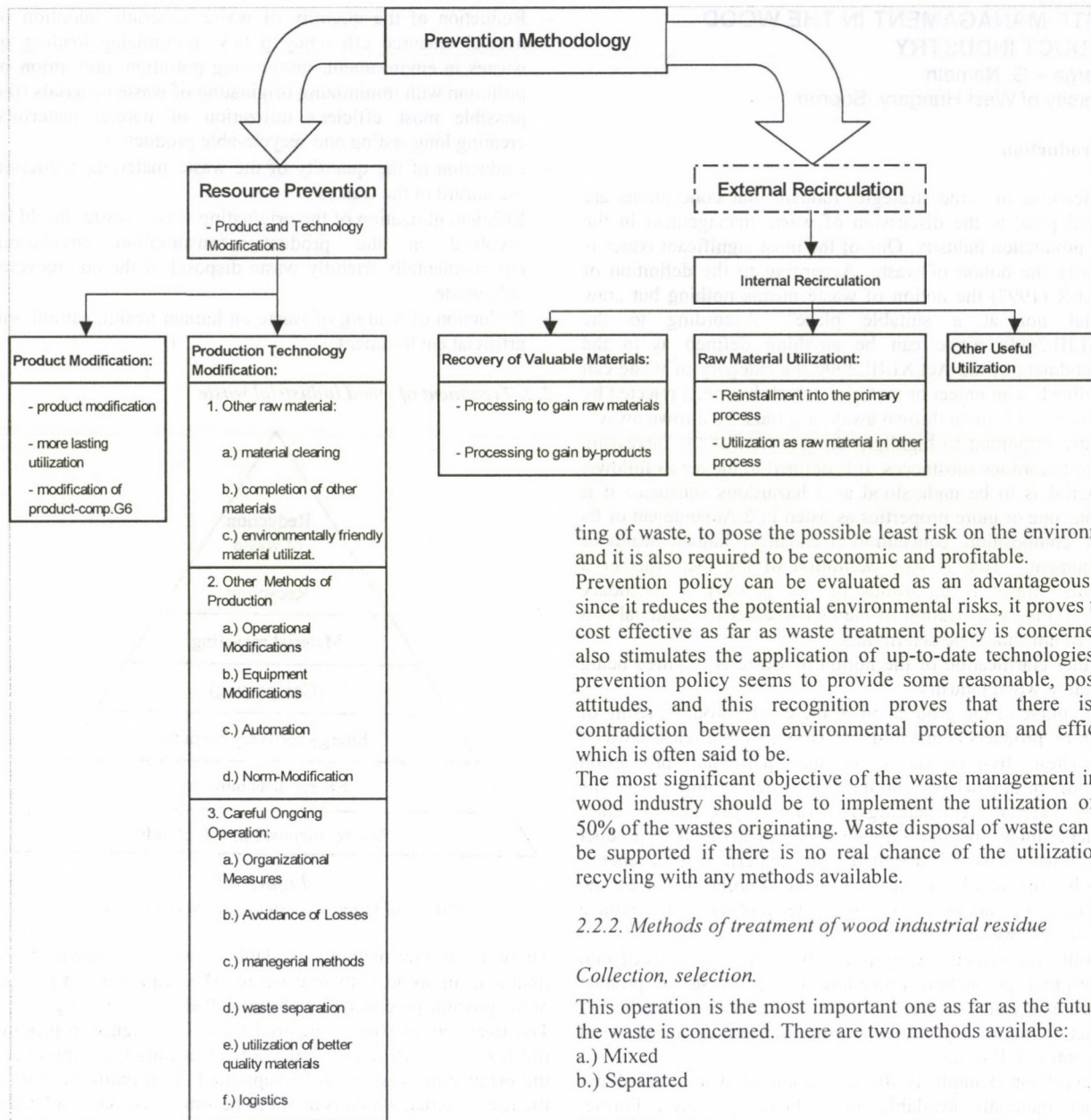

Figure 2 Methods of prevention and reduction of waste material originating [4.]

- product prevention
- technological prevention

Prevention should be in a close connection with the product or its characteristics. Minimizing the risks of environmental pollution should be taken into consideration in the course of production, in the phase of the utilization of the product and also in that final phase when the product is being treated as a waste material. The prevention at the technological level should highlight the development of the application of purity technologies resulting in waste economical management Workshop management, sophisticated operational methods, energy saving policy and application of less hazardous substances should also be involved.

On the basis of the previous experiences that particular finding can be concluded that there is no general method available in the industry, which an overnight would be able to provide the particular technology resulting in significant reduction of waste emission. The new technology is required to reduce the origina-

ting of waste, to pose the possible least risk on the environment and it is also required to be economic and profitable.

Prevention policy can be evaluated as an advantageous one since it reduces the potential environmental risks, it proves to be cost effective as far as waste treatment policy is concerned. It also stimulates the application of up-to-date technologies. So prevention policy seems to provide some reasonable, positive attitudes, and this recognition proves that there is no contradiction between environmental protection and efficacy, which is often said to be.

The most significant objective of the waste management in the wood industry should be to implement the utilization of the 50% of the wastes originating. Waste disposal of waste can only be supported if there is no real chance of the utilization or recycling with any methods available.

2.2.2. Methods of treatment of wood industrial residue

Collection, selection.

This operation is the most important one as far as the future of the waste is concerned. There are two methods available:

- Mixed
- Separated

Pre-treatment

The real function of the pre-treatment procedure is to modify the unfavourable characteristics of the waste in order to achieve a better condition of utilization of the following phase of the production. The available examples in the wood industry are as follows:

- Chopping wastes
- Briquetting, pelleting (energy consideration)
- Drainage (materials with high water content - eg.:silts-) drying or mechanical way
- Selection of liquid and firm phases
- Neutralizing acid and alkaloid substances
- Burning of organic substances and other burnable, defibrating (pyrolysis)

Transition-Storage

To eliminate time sequence differences transition storage is to be applied.

Transportation

One of the risk factors of transportation is the dissemination of dangerous substances, the other one is misplacement of the waste.

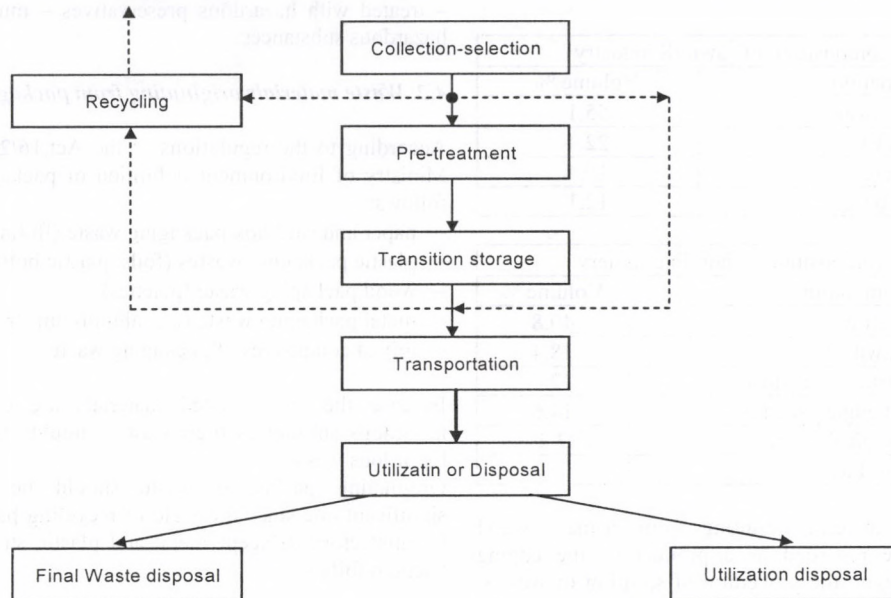

Figure 3
General scheme of wood industrial residue treatment [1]

Waste disposal

It is the final phase of the waste management. Two possible methods are available:

- recycling of waste, or recycling combined with disposal
- final waste disposal

2.2.3. Rules and regulations of waste management

According to the legislations there are three crucial factors as follows:

- record keeping of waste management at the premises
- storage, treatment and transportation must be authorized
- tracing and reporting waste from origin to disposal

3. Wood-residue

There are several methods available for the cluster analysis and classification of industrial wood by-products. The most prevalent ones are the categories applied by Vorreiter. These are as follows: place of originating, size, transportation, storage, wood species, purity and homogeneity and moisture content.

Meanwhile the domestic raw material stock and the imported quantity – (which is relevant to 8-9 million m³ round wood /annum is being processed 2,5-3-3,5 million m³ waste / estimated value) is

originating. This tremendous quantity highlights how significant issue the waste management is.

Table 1 waste of 1 m³ round wood [7.]

Sawmilling industry	35-40 %
Veneer-plywood industry	50-60 %
Furniture component production	65-75 %
Window-door production	60-70 %

Wood based residue management has not been implemented in Hungary. As far as the question of bark and sawdust is to be backed – even after the procedure of briquetting. As far as the chunky waste materials are concerned fibre and wood particle board production should be favoured.

Both the raw materials originating from domestic forests and imported ones are dominantly processed by the sawmill industry. Waste from felling and waste from the sawmill industry represent more than ¼ of the total waste. Since the sawmilling industry's 50-60% yield is regarded to be very-low, that is why a plant by- product raw material originating and it is utilization require very special attention.

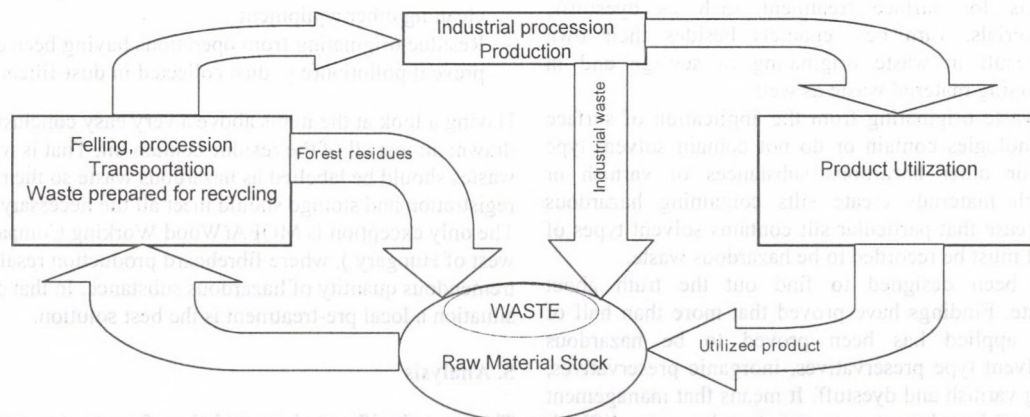

Figure 4 The wood based waste as the part of actual raw material stock [3]

Table 2 Plant by-product composition of the sawmill industry and building joinery

By-product composition of sawmill industry	
Denomination	Volume %
Chunky waste	55,1
Sawdust	22,4
Particle	10,4
Peeled bark	12,1

By-product composition of building joinery	
Denomination	Volume %
Particle	49,8
Sawdust	18,4
Mixed: particle+sawdust	12,7
Chunk and edging wastes	14,6
Technological waste	2,2
Board trim	2,3

Basically the wood material resulting from primary wood production should be regarded as a product of the edging operation. It originates in the procedure of splitting of wastes, cross-cutting, edging and it consists of sawdust and bigger sized, solid off cuts. These procedures are followed by a secondary wood production in which some further by-products originating particles in the course of cutting, chiselling, drilling and sander dust in the course of sanding.

4. Non-wood based waste

4.1. Preservatives, adhesives, materials for surface treatment, sealers and their waste

Preservatives applied in wood industry contain or do not contain organic compounds, there are metal-organic compound preservatives, inorganic compound preservatives, preservatives containing hazardous substances, and other preservatives are applied identified as hazardous substances by the Act. 16/2001. Ministry of Environment.

- Waste of adhesives and sealers (it is regarded to be a sort of a hierarchy)
- Liquid waste containing solvent type preservatives, other toxic substances, adhesives, sealers
- Liquid silts and silts containing solvent type preservatives, adhesives, sealers
- Waste originating from the application and trading adhesives and sealers (dewatering materials are included)
- Waste originating from application of sealers and adhesives containing hazardous substances
- Other different non hazardous waste

Other materials for surface treatment such as dyestuffs, combined materials, varnishes, enamels besides their own wastes may result in waste originating in sewage and in different packaging material waste as well.

Some of the waste originating from the application of surface treatment technologies contain or do not contain solvent type preservatives or other hazardous substances of varnish or dyestuff, which materials create silts containing hazardous substances. In case that particular silt contains solvent types of preservatives it must be recorded to be hazardous waste.

Research has been designed to find out the truth about hazardous waste. Findings have proved that more than half of the materials applied has been proved to be hazardous substance.(solvent type preservatives, inorganic preservatives, silts containing varnish and dyestuff. It means that management of the non -wood based wastes represents a lot more difficult job for the wood industrial companies than the management of

wood based waste. To crown it all the waste of wood materials – treated with hazardous preservatives – must be recorded as hazardous substances.

4.2. Waste materials originating from packaging

According to the regulations of the Act.16/2001.issued by the Ministry of Environment definition of packaging waste are as follows:

- paper and card box packaging waste (fluting medium)
- plastic packaging wastes (foils, plastic bottles)
- wood packaging waste (palettes)
- metal packaging waste (e.g. aluminium straps etc.)
- mixed composites of packaging waste

In case the above listed materials are contaminated with hazardous substances their waste should also be recorded as hazardous waste.

Originating packaging waste should be regarded not a significant one since the yield of recycling packaging materials is satisfactory. (Except metal and plastic straps, and waste of vacuum foils.)

4.3. Waste originating from the operation and maintenance of machinery

In the course of the ongoing operation of wood machinery the originating waste are as follows:

- oily, greasy rags, different wiping materials
- solvent sediment(applied while cleaning)petroleum, gasoline, petrol and their impurities
- sediment, silt originating from alkaline fat dissolvents
- waste engine oil originating from base machines, engines, bearings,
- dye residue
- hydraulic liquid or oil originating from hydraulic structures
- grease and oil packaging materials, boxes

There are some other non-defined absorbents, wiping clothes, filters, protective clothing, which represent values of safety control rather than maintenance.

4.4. The general types of hazardous waste

The following items of priority have been carried out according to experimental observation:

- Materials containing mineral oil, oil and silt originating from oil-separating equipment
- Dyes, paints, varnishes, lacquers, pigments
- Resins, latex, softeners, glue, /adhesives,
- Batteries and other electrical cells
- Residue from containers and substances originating from cleaning other equipment
- Residue originating from operations having been designed to prevent pollution(e.g. dust collected in dust-filters)

Having a look at the items above a very easy conclusion is to be drawn: almost all of the residue contain oil. That is why all the wastes should be labelled as hazardous waste so their registration and storage should meet all the necessary demands. The only exception is MOFA(Wood Working Company in the west of Hungary), where fibreboard production results in a tremendous quantity of hazardous substance. In that particular situation a local pre-treatment is the best solution.

5. Analysis

The most significant characteristics of waste management in the wood industry in Hungary are as follows:

- The quantity of the originating waste has been increasing, so has the quantity being disposed. The efficiency of waste management has been developing but the current situation can not be concluded to be satisfactory.
- The regulation policy of waste management is not suitable
- The yield ratio is low but compared to other industries its ratio is relatively better since the efficiency of utilization of wood residue, wood-based materials, wood products are much better both in energy generation and recycling.
- Unfavourable economic conditions.

6. Solution

6.1. Recycling in the wood industry

As far as recycling is concerned three crucial factors should be taken into consideration:

1. Collecting and recycling waste at the local level of wood industrial workshops can only be supported if it is economical, in the very case if the plant by-product is cheaper than the primary one.
2. Collection and recycling of waste can be described as an economical one at industrial level if the costs of waste collection should be covered by the costs of plant by-products and the costs of recycling is lower than the costs of collection and waste disposal.
3. Ecological viewpoints should be seriously taken into consideration: environmentally friendly technologies should be applied even if these technologies are more expensive.
4. The most essential aspects of recycling are to be shown in the figure 5.

The next figure was designed to display the procedure of recycling of worn furniture and particleboards. This technology is mainly widespread in Germany.

6.2. Energy utilization

Energy utilization is as old as mankind. Nowadays – after a relatively long period of being put aside – wood material seems to be loaded with a very significant job to replace those energy sources, which have been regarded to be indispensable to human energy consumption such as coal, petroleum and nuclear

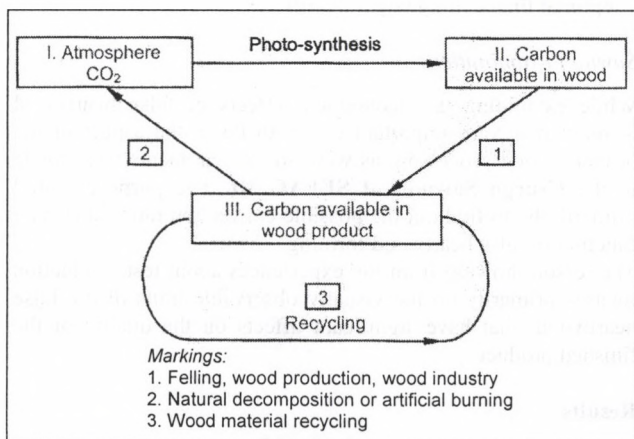

Figure 5

The circulation of the carbon (C) closed up in wood (atmosphere – forest – wood product – atmosphere) and the correlation between the carbon (C) and the wood material.[5.]

energy. But nowadays these energy sources are exhaustible resources on one hand and are considered not to be environmentally friendly on the other. That is why wood based energy resources (dendromass) should be dynamically supported.

Almost all the by-products in the wood industry is applicable for energetic utilization. These materials should be collected, which is a very significant job and a large quantity of energy input is required. Its fuel value is only 3 –8 (10) %. [1.]

The most efficient ways of energy generating are as follows: Direct burning, in Original status, Homogenizing preparation after chipping, Compaction after briquetting, Pyrolyzation, Hydrolysis, Hydrogenizing[6.]

6.3. Elimination of hazardous substances

The best way of this particular environmental policy strategy is to transport waste and burn them in waste burners. In the course of our research we have experienced some very interesting and pleasing technological solutions. For example synthetics hydraulic oil was applied to grease transporters.

References

- [1] Dr. László, **Vermes**: Waste management, waste utilization. Mezőgazdasági Kiadó, Budapest, 1998.
- [2] Styex Oktatási Stúdió Kft. (Educational Studio Ltd.) Dr. Mária **Bubonyi**: Waste management. Lecture Notes, Budapest, 2001. Resource: National plan of Waste Management
- [3] Lajos, **Szalay**: Utilization of wood residue. Műszaki Könyvkiadó, Budapest, 1981.
- [4] Reduction of waste in the course of production, Institute of Environment m
- [5] Management, Environmental Information Office (Added: **Olessák**, Dénes) Notes, Budapest, 1995.
- [6] Dr. **Söberl**, Miklós: Industrial environment protection, Lecture, Sopron, 2002.
- [7] Dr. **Marosvölgy**, Béla Energetic utilization of wood residue, I-IV. Magyar Asztalos, 1991. 05. 08.
- [8] Dr. Sándor, Molnár Wood sciences, Mezőgazdasági Szak-tudás Kiadó, Budapest, 1999.

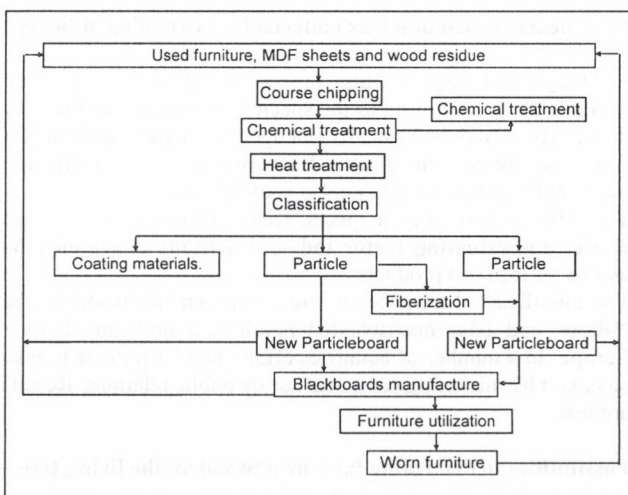

Figure 6

Attrition milled fibre and wood particle to be recycled [5.]

EXAMINATION OF FALSE HEARTWOOD FORMING IN BEECH TREE IN THE WOODS OF SEFAG RT.

J. Rumpf – B. Biró
University of West Hungary, Sopron

What is false heartwood?

Heartwood: "Inner zones of the wood, which do not contain living cells anymore in the standing trunk, and where spare nutrients (eg. starch) are generally disintegrated or transformed into **heartwood formatting material**. It often looks **darker** than the sapwood (heartwood stain), though a difference in color is not always visible (intermediar tree)."

Beech (*Fagus sylvatica*) belongs to the facultative heartwood producers, and often forms red heartwood in advanced age.

Heartwood forming is a long time process, in Hungary it appears between the ages of 70-120 years. It is a **physiologically normal process** that is related to the age: thyllis forming of the trachea system, moisture reduction in the wood, degeneration of nucleus and mitochondrium at the parenchyma cells, hydrolysis of starch, formation of heartwood formatting material. The wood becomes dark because of the implantation of heartwood formatting material.

Attributes of the false heartwooded wood

There are a lot of delusions about the false heartwooded beech wood. The followings must be pointed out:

- the physical and mechanical traits of the false heartwooded and white wood are almost the same, in some traits the false heartwooded part is even better,
- its **wearing qualities are 25–30 %** better than "normal" wood, which means that false heartwooded wood is a lot more advantageous for parquet flooring, coverings, and for table surfaces,
- can be dried with almost the same technology as "normal" wood because of almost **similar sorption qualities**,
- with proper steaming the **color difference** can be favorably **homogenized**,
- can be glued excellently, its **shear strength is 5-7 % higher** than the non false heartwooded wood,
- does not have fungal infections, can be used for interior purposes.

Drawbacks: **worse permeability** because of thyllising, increased danger of **"card-like" separation**, increased warping and splitting.

False heartwooded beech as material for sawmilling industry

In Hungary at sawmills that process deciduous tree species, **beech is 22 %** according to the species composition of the used wood. They produce basically unedged sawnwood and parquet strips, but the amount of edged sawnwood is also significant. Meaningful part of the products is marketed abroad.

The false heartwood as a special feature of tree species is still clearly a **devaluating factor** today: it radically determines the quality of logs and products.

The significant difference in value between the wood of the "white" and false heartwooded beech is a problem all over Europe. In a number of countries efforts had been made to take against it by marketing campaign, or by public relations. Results are few.

Possibilities to determine false heartwood on the living tree

Today the false heartwood research is given more and more attention. One of its most important elements is the identi-

fication of false heartwood **on the living tree** possibly with the least destruction. The destruction-free examination of the inner condition of a living tree is of **great economical significance**. Great efforts have been put into this section of wood examination in our country, as well as in German and Swiss Universities.

At present the testing of the following ideas is in process:

- **"Vitamat"**: An instrument developed by the professors of the Zurich University for the measuring of electric conductance. The determinant elements are: water content, ion concentration and temperature. It takes about 15 minutes for two persons to make an examination.
- **"Electric resistance tomograph"**: A research project of the Göttingen University. The instrument measures electric resistance through the 3 mm thick pins put in the xylem.
- **"Sylvatest"**: Had been developed at Lausanne Forestry College. Works with the use of ultrasound.
- **"Computer tomograph"**: This method meets the best with the requirements for anti-destruction, but is very expensive and slow. Its industrial use is not yet accomplishable.

Examination of beech false heartwood forming in the forest resources of Sefag Rt.

The purpose of doctoral research that started in 2000 was to examine the complex problems of false heartwood forming. The research involved a larger district.

The research has been taking place in the beech sites of the Somogyi Erdészeti és Faipari Részvénytársaság (**Somogy Forest and Woodworking Corp.**).

Forest management units that were involved in the research:

- **Kaposvár Forest Management Unit**
- **Igal Forest Management Unit**
- **Zselic Forest Management Unit**
- **Iharos Forest Management Unit**

The amount of survey samples involves almost 2000 pieces of tree-trunks, which had been examined in almost 40 forest subcompartments.

Purpose of the research:

- Determination of the possible **ecological parameters** that may influence the false heartwood forming.
- Establishing the amount of false heartwood, measuring the caused difference in the assortment structure.
- **Costs and earnings analysis** on corporation level, examination of income reduction.
- **Determination of economically optimal age of maturity and optimal final cutting target diameter.**

Sawmill examination:

While examining the economical effects of false heartwood forming it is very important to get to know the aspect of the primary wood processing as well, so measurements were made in the **Csurgó Sawmill of SEFAG Rt.** The purpose would primarily be to find out the possible conversion ratio taken as a function of false heartwood forming.

The lesson drawing from the experiences about test production focuses primarily on the visually observable traits of the false heartwood, that have significant affects on the quality of the finished product.

Results

According to the processed datas we can state the followings:

- There is no false heartwood forming until the forest resource is **60-70 years old** (diameter at breast height: 25-30 cm), **after this age the false heartwood appears**. Above this age

the amount of false heartwood exponentially grows, reaching 100% over the age of 110 years.

- The **most important factor** in the growth of false heartwood is **diameter** (horizontal expansion) age and tree height (vertical expansion).
- **Abnormal (sick) false heartwood appeared in a very small degree** in the beech forests in Somogy.
- The loss of value because of false heartwood – modeling the best stands – can reach 3,400-6,800 HUF/gross m³.
- The average loss per hectare at mature layer of trees (100-120 years, when the average diameter at breast height reaches 45-50 cm) is 4,4-5,1 million HUF.

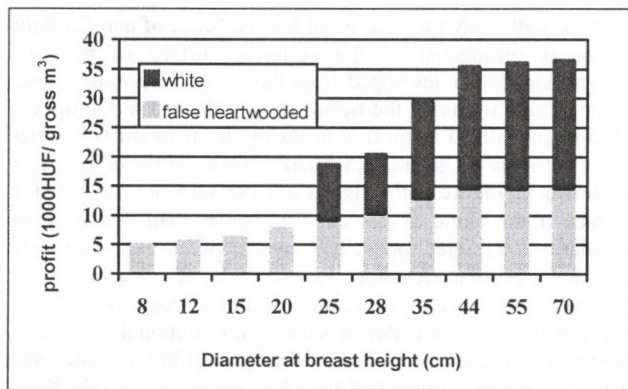

Chart 1

Change of profit due to false heartwood forming

Our results compared with the parameters considered to be significant by forestry such as biochemistry, genetics and

others, make it possible to make meaningful conclusions to the whole of beech management thus contributing to the pressing back of false heartwood formation.

References

- [1] **Albert L. et al.** (1998): Eltérések a vörös gesztű bükk (*Fagus sylvatica* L.) faanyagának kémiai paramétereiben. *Faipar*. 1. szám 36-37 p.
- [2] **Biró B.** (1999): A bükk álgesztesedésének vizsgálata a Zselici erdőgazdasági tájban a Somogyi Erdészeti és Faipari Rt. Kaposvári Erdészetének területén. Diplomamunka, Soproni Egyetem.
- [3] **von Büren, S.** (1998): Buchenrotkern: Erkennung, Verbreitung und wirtschaftliche Bedeutung. *Schweizerische Zeitschrift für Forstwesen* 149(12). 955-970 p.
- [4] **Illyés G.** (2002): Az alapanyag minőség és a fűrészáru minőség összefüggései és azok hatása a termelési tevékenység hatékonyságára, lombos fafajú alapanyagot feldolgozó fűrészüzemekben. Diplomamunka, Nyugat-Magyarországi Egyetem.
- [5] **Molnár S.** (2001): Az álgesztes bükk kiváló tulajdonságokkal rendelkezik! *Faipar*. 2. szám 19 p.
- [6] **Seeling, U.** (2001): Kerntypen im Holz. Konsequenzen für die Verwertung am Beispiel der Buche. www.forst.unifreiburg.de/fobawi/fob/fob_lehre/211b/material_2002/01_3_Kernholzbildung.pdf
- [7] **Weihls, U. – Dubbel, V. – Krummheuer, F. – Just, A.** (1999): Die elektrische Widerstandstomographie – Ein vielversprechendes Verfahren zur Farbkerndiagnose am stehenden Rotbuchenstamm. *Forst und Holz* 54. 166-169 p.

APPLICATION OF PRISMS FOR SOLAR COLLECTORS

I. Patay – Gy. Babák
Tessedik Sámuel College, Szarvas

Introduction

There is a wide range technical and technological instrumentation, which can be utilized, in the direct solar applications. The level of energy concentration is essential from point of view of application as it basically determines the scope of adaptability. The caloric systems based on light extinction play an important role in the low temperature range heat energy supply, while the photo-electric or rather thermo-electric solar panels act mainly as local energy sources in the electric energy supply.

It has been well known for a long time that the electrical radiation can be concentrated on a high level. The lenses are the typical concentrators but they are highly dependent on direction of light. The flat mirrors and the parabolic mirrors, used widely as solar collectors, are similar to them [1].

The prisms are known as ray-dividing and dispersion optical devices. However at some conditions, they can be applied as concentrators e.g. in solar collectors. Hereafter these conditions will be determined theoretically.

Materials and methods

In the physics the prism is interpreted as a triangular, prism-shaped solid body. In mathematics the prism is simply a prism shaped body with an arbitrary cross-section, congruent base and top as well as planesides. In our interpretation the prism is such a geometrical body, the cross-section of which continuously decreases along its optical axis towards the direction of light, and its surface can be both a plane surface and a curved surface of any kind. Accordingly a great variety of geometrical prisms can be developed (Figure 1). Any optically transparent material can be used for the monolithic solid material of prisms, which is characterized by the absolute index of refraction.

The base of prisms is used as a collecting surface while the much less opposite surface is used as a concentration surface. An optical fibre was joined to the concentration surface to lead away the light.

The dimensions of prisms are theoretically arbitrary but it is expedient to choose such geometrical dimensions, which are much bigger than the wavelength of light. The different cross-section prisms, besides their dimensions, can be different in

their cone angle or (in case of prisms covered by planes) angle of intersection. The cone or intersection determines the theoretical scale of concentration, which is interpreted as the ratio of the collection and the concentration surfaces. For the sake of simplicity, a two-dimension model, developed as a central cross-section of a cone prism, will be studied hereunder. If the dimensions of a prism are much bigger than the wavelength of infrared range of solar radiation (1-2,5 μm), the propagate of rays can be studied on the basis of axioms of geometrical optics [2,3].

Results

First we will study the case when the incidence of parallel light beams is orthogonal to the collector surface of the two dimensional prism developed from the planar section of a cone prism. If one wants all the beams to be collected in the optical fibre in an ordered form, it is necessary to maintain very strict ratios between the geometrical characteristics of the prism. As it is shown in Figure 2 the light does not step out on the side surface if the angle of descent (γ) smaller than the angle of capillarity interpreted for the crossover between the prism body and its environment (α_h). From point of view of light concentration the most favourable situation occurs if any light beam arriving to the collector surface after optional number of reflections, reaches the surface of the optical fibre (here denoted with 'd') by such a way that the angle between the light beam and the axis of incidence is less than the angle of capillarity:

$$\beta \leq \alpha_h$$

If only one reflection is allowed, based on the limit case $\beta \leq \alpha_h$ and at a given 'h' height of prism, the diameter of the collection surface will be the following:

$$D = 2x + d \quad [\text{m}] \quad (1)$$

where from the triangle based on the propagate of rays of the outermost light input is

$$x = d \frac{\text{tg}\left(45^\circ - \frac{\alpha_h}{2}\right)}{\frac{1}{\text{tg}\alpha_h} - \text{tg}\left(45^\circ - \frac{\alpha_h}{2}\right)} \quad [\text{m}] \quad (2)$$

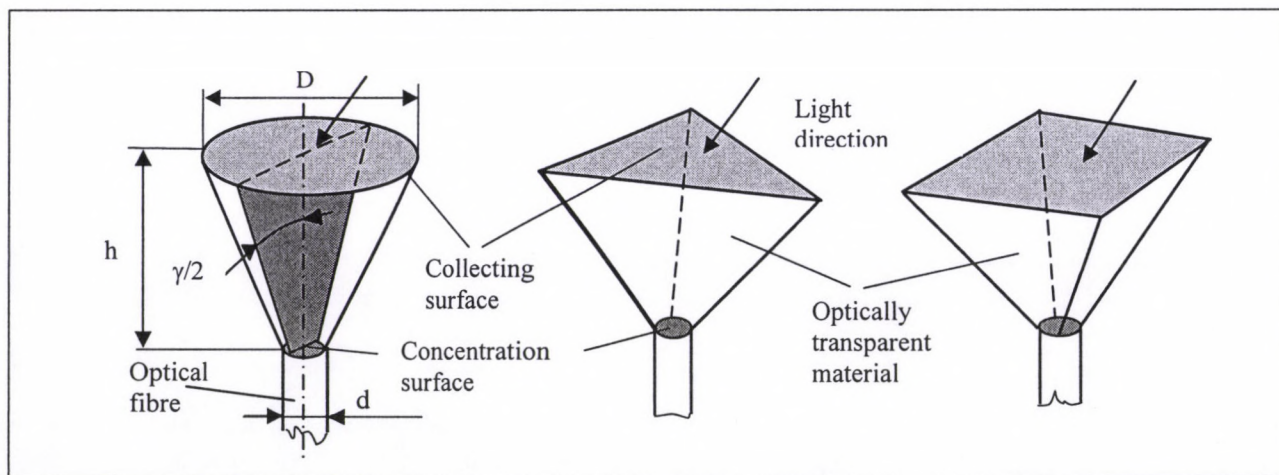

Figure 1
Simple prisms as concentrators

while the cone angle of the prism is:

$$\gamma = 90^\circ - \alpha_h, \text{ where} \quad (3)$$

$$\sin \alpha_h = n_{12} = \frac{1}{n_{21}}$$

if n_{12} is the index of refraction of the material of prism to the environment and n_{21} is its reciprocal (e.g. for the glass-air transition $n_{ea} = 1,5$, $\alpha_h \cong 42^\circ$.)

Based on the equations (2) and (3) the relationship between the three geometrical and α_h optical characters is the following for the borderline case:

$$h = \frac{x}{\operatorname{tg} \frac{90^\circ - \alpha_h}{2}} = \frac{D-d}{2 \operatorname{tg} \frac{90^\circ - \alpha_h}{2}} \quad [\text{m}] \quad (4)$$

(The borderline case means that in case of such geometrical ratios, any light beam reaching the collection surface of the prism orthogonally, deflects towards the optical fibre joined to the prism, and the light flux in the optical fibre consists of parallel light beams.)

The concentration in a borderline case is the following:

$$k = \left(\frac{D}{d}\right)^2 = \left(\frac{2h \cdot \operatorname{tg} \frac{90^\circ - \alpha_h}{2}}{d} + 1\right)^2 \quad (5)$$

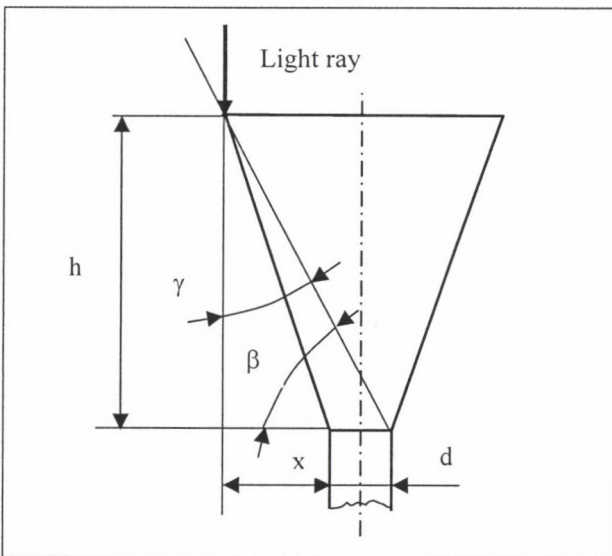

Figure 2
Propagate of rays at right angles of incidence

The result gained in equation (5) can be generalized. If z number of reflections is allowed, the available concentration is:

$$k = \left(\frac{2htg \frac{90^\circ - \alpha_h}{2z}}{d} + 1\right)^2 \quad (6)$$

while the general relation for the geometrical ratios is the following:

$$h = \frac{D-d}{2 \operatorname{tg} \frac{90^\circ - \alpha_h}{2}} \quad [\text{m}] \quad (7)$$

In case of geometry shown in equation (7) there is a special dispersion of light flux in the optical fibre: in the core of the optical fibre, the Φ light input can be measured on the collecting surface, while on the curved surface of the fibre there is a much bigger, so-called peripheral or line luminous flux as follows:

$$\Phi_k = \Phi \cdot \pi \cdot \frac{D^2 - d^2}{4d\pi} = \Phi \frac{d}{4}(k-1) \quad \left[\frac{\text{w}}{\text{m}}\right] \quad (8)$$

In general ($0 < \alpha < 90^\circ$) the route of light ray in the prism depends on the geometry of the prism i.e. it depends on the point where the rays reach the collecting surface. In this case the points of incidence – from point of view of advancement in the optical fibre – are not equivalent. The direction of rays passing through the concentration surface (cross section) becomes disordered, the rays pass through the optical fibre joined to the prism mostly by reflection. By the increase of the angle of light less and less rays pass from the prism to the optical fibre. One of its reasons is the dispersion of the light at the wall of prism. This loss can be avoided if the sidewall of the prism is covered by a catoptrical material (e.g. it is mercurated).

Another reason is that because of prism geometry, the speed component of rays moving towards the optical axis, decreases in each reflection as a result of rules of reflection.

Thus the equation (8) is the following for the general case:

$$\Phi_r = \Phi \cos \alpha \frac{d}{4}(k-1)R(\alpha) \quad \left[\frac{\text{w}}{\text{m}}\right] \quad (9)$$

The $R(\alpha)$ function for a given prism geometry can be exactly determined by the use of Fresnel formulas [4], or can be drawn based on measurements. Φ_r is the average cross-sectional light conductance of the optical fibre in the equation.

Based on similar considerations, the ratios between the geometrical features of prisms of other shape can also be determined and the propagate of rays can be studied.

Applications

Theoretically it is possible to construct collecting surfaces of optional size and dimensional structure by use of the above-mentioned prisms. The collector constructed of many collecting prisms can be utilized either in optical or in thermal systems [5,6].

The advantage of the optical system is that the energy can be directed from the collector to the site of utilization in its original form without transformation and auxiliary power (Figure 3). The dispersion of material of light cables used for guiding of light is wavelength dependent therefore it could be useful to grade the collected light energy according to the wavelength range e.g. by the help of optical catchers/filters then direct it to the users [7].

The main advantage of use of thermal collectors is that the operational temperature range can be highly increased because of concentration of light. The liquid container of the collector absorbs the solar energy similarly to the absolute black body and hot points are developed around the prism chunks (Figure 3.b).

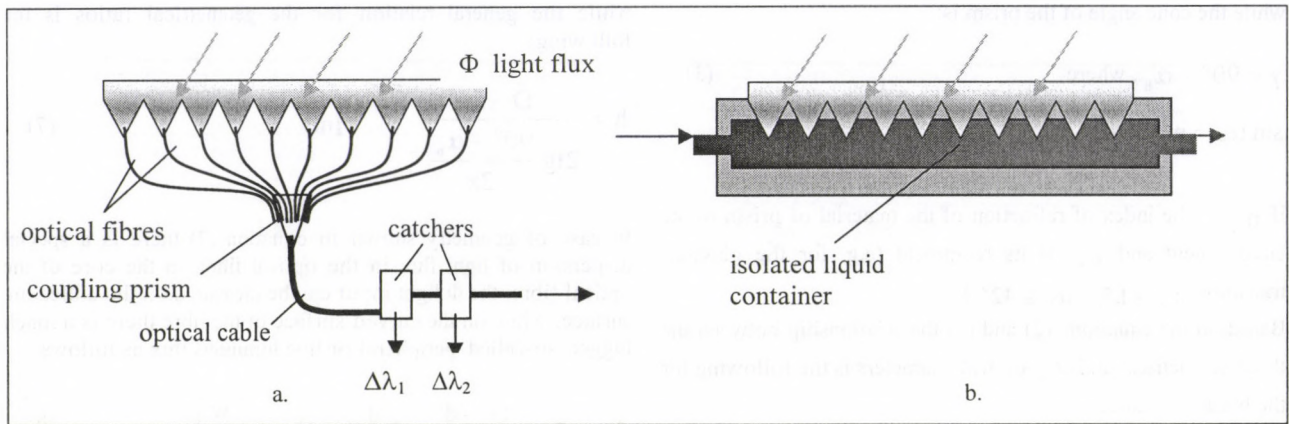

Figure 3
Optical (a) and thermal (b) applications of prism-type collectors

The transparency of the liquid container is optically limited from inside, and the thermal radiation is available only through a surface proportional to the concentration surface. In the interest of high efficiency, optical characters of the absorbent material (liquid) are also important. The aim is the total absorption of light not depending on the wavelength. It can be realized e.g. by use of optically 'black' liquids.

References

- [1] Johansson, T.B. et al: Renewable energy sources for fuels and electricity. Island Press, Washington, 1993.
- [2] Ábrahám, Gy. Szerk.: Optika, Panem – Mc. Graw – Hill, Budapest, 1998.
- [3] Erostyák, J. – Kozma, L.: Általános fizika III. Fénytan, Dialóg Campus Kiadó, Pécs-Budapest, 1999.
- [4] Young, M.: Optics and Lasers, Springer-Verlag, Berlin, 1993.
- [5] Patay, I.: Zárt optikai síkkollektorok megvalósítási lehetőségei, Agrárműszaki K+F műhelytanácskozás előadásai. Szarvas, 2001. 62-66p.
- [6] Patay, I. – Babák, Gy.: Prizmák alkalmazása optikai napkollektorokhoz, Mezőgazdasági Technika, XLIV. évf. 3. sz. 2003. 2-3p.
- [7] Patay, I. – Babák, Gy.: Prizmák alkalmazása napkollektorokhoz, TSF Tudományos Közleményei, Vol. 3. 65-78p.

COMPARATIVE ENGINE TESTS AND ENVIRONMENTAL EFFECT ANALYSIS OF FUELS MADE OF ANIMAL FAT AND VARIOUS KINDS OF PLANT OILS

L. Jánosi¹ – J. Hancsók² – F. Kovács²

¹ Szent István University, Gödöllő

² University of Veszprém

1. Introduction

Many organizations have been dealing in Europe with renewable energy sources based on biomass with growing activity since 1988. We can say that all of the EU member states are committed using alternative fuels [1, 2]. Production and application of biological fuels is free opportunity on the market, and their use serves several purposes at the same time. For example it is a source for supporting agriculture, it reduces Europe's dependence on other countries concerning energy supply, it has a favourable effect on the environment, upgrades the CO₂ management of the atmosphere etc.

Although remarkable steps have not been done in this topic in Hungary during the past decade, there is a need to deal with the production and use, because after Hungary joins the EU, the same regulations will be valid as for the present member states. On this field we have a quite big lag, comparing Hungary even to the other countries which will join the EU together with us.

In this essay we only deal with the use of biodiesel, of the fuel produced from renewable energy source. Furthermore we only survey the recycling of used frying oils and animal fats. Serious research work is carried on in the topic from the 80's. Nye and his colleagues [3] produced the first quantity testable in laboratory and carried out the first motor tests in 1983, then Mittelbach and Tritthart [4] continued the researches in 1988. In 1992 Mittelbach and his co-workers were the first to perform processing, transesterification and laboratory tests using samples derived from 13 different sources. They graded the fuels by analysing many properties of the products [5], and they compared the results to the current biodiesel regulations being valid in Austria.

We worked out a system in our department for grading fuels based on the tests included in the standard ECE R-49. During the investigations we applied the so-called 13 points measurement combined with the analysis of exhaust gas and with engine indication. The method can be studied in details in the report of L. Jánosi, D.R. Ess, H.G. Gibson published in 1996 [6].

Considering that used frying oils and other residues of the food industry are already classified in Hungary, too, as dangerous residues, analysis of the circumstances of their utilization and consideration of the possibilities is nowadays an actual task. For this reason we carried out chemical, energetical and environmental examinations, and the results of these can be seen in this essay.

2. Material and method

2.1. Used frying oil: dangerous waste or industrial base material?

First of all, the question may be raised whether we are talking about a dangerous waste or a raw material for the industry. According to the actual Hungarian laws the used frying oil belongs to the dangerous wastes, that must be collected separately and eliminated under attested circumstances. On the contrary, used frying oil residues still flow into the public drains.

On the other hand, most of the collected oils are used for animal forage. However, there are further options, too, for recycling used frying oils. The simplest is for example elimination by burning. Further application can be production of soap by hydrolysis or after appropriate purification use as lubricating oil or hydraulic oil. About some details of the latter application can be read in the report of L. Jánosi and N. Józsa (1999) [7].

2.2. Basic physical and chemical characteristics of the collected base materials and of the processing technology

We collected the base materials used in the experiments from various households. Considering that there is no standard for the quality of used frying oils, we did not adapt any regulations, the collection of the samples was coincidental.

We pretreated some of the collected samples (from G-1 to G-5) as it is shown in Table 1.

The technology of transesterification was discontinuous, that is a definite quantity (25 dm³) of oil containing cosolvent was heated to 40-60°C, and the catalyst (acid/basic), in two parts, previously dissolved in methanol, was added under continuous mixing at constant temperature. After transesterification the residues of alcohol were removed by distillation and those of the catalyst by filtration. After decanting, the product was convenient for use in engine.

Before using them in engine, the physical and chemical characteristics of the produced materials were tested. The results of the tests can be seen in Table 2.

Table 1 Identifying data of plant based fuel samples and some important characteristics of the transesterification

Code of the sample	Name of the sample	Primary treatment before esterification	Place of esterification	Temperature of esterification	Amount of methanol	Amount of catalysts	Period of mixing	Period of decanting	
N	G-1	Sunflower methyl ester	∅	Insulated laboratory esterifier	40-60°C	0.15 dm ³ /dm ³	15 g/dm ³	30-50 min	1.5 hours
K	G-2	Hardly soiled used frying oil	Decanting, filtration	Insulated laboratory esterifier	40-60°C	0.15 dm ³ /dm ³	15 g/dm ³	30-50 min	1.5 hours
T	G-3	Less soiled used frying oil	Decanting, filtration	Insulated laboratory esterifier	40-60°C	0.15 dm ³ /dm ³	15 g/dm ³	30-50 min	1.5 hours
R	G-4	Rape-seed methyl ester	∅	Insulated laboratory esterifier	40-60°C	0.15 dm ³ /dm ³	15 g/dm ³	30-50 min	1.5 hours
ZS	G-5	Animal fat methyl ester	Preheating, filtration	Insulated laboratory esterifier	40-60°C	0.15 dm ³ /dm ³	15 g/dm ³	30-50 min	1.5 hours
	G-7	Cold pressed sunflower methyl ester	Technology is unprofessional. Alkaline and acidic treatments were applied coincidentally, while the material was heated and mixed. The material was decanted after esterification.						

Table 2 Results of the tests

Sample code	Density, (d ₄ ²⁰)	Water cont., Karl-Fischer, ppm	Sulphur content, ppm	Flash point Pensky-Martens °C	Kinematic viscosity at 40°C, mm ² /s	TAN, mg KOH/g	Cloud point, °C	CFPP*, °C	Saponification number mg KOH/g	Iodine-bromine number g I/100g	Potassium content, mg/kg	Sodium content, mg/kg
G-1	0.8829	474	1	128	4.54	0.04	0	-6	204	12.5	3	<1
G-2	0.8885	389	10	128	4.78	0.05	+2	-2	208	103.5	4	<1
G-3	0.8830	436	2	124	4.61	0.06	0	-7	211	106.5	5	<1
G-4	0.8769	442	7	128	4.51	0.1	+3	-7	195	103.0	5	<1
G-5	0.8816	512	3	127	4.96	0.08	+8	+4	211	80.0	5	<1
G-7	0.9184	485	0	108	31.0	0.4	8	-	205	11.0	<1	<1

*Cold filter plugging point

2.2. Engine tests

The engine tests were carried out in a test room. The type of the engine: Perkins 1004-4T. The feature of the engine is detailed in the literature [6]. During the measurements instructions of the ECE R-49 standard were followed that is the characteristics of the engine were re-corded at 13 points at different loads and in the same time the parameters of the exhaust gas belonging together were registered, too. From the properties of the exhaust gas the CO, CO₂, C_nH_m residue and soot content were measured. The indicator diagrams were taken down at each measuring points. From the results of all these measurements each type of the fuels can be characterized on the base of the effective power-output and the components of the emitted exhaust gas.

3. Results

3.1. Based on the experiences of the transesterification of the processed animal fat and plant oil samples, it can be stated that the discontinuous esterifying method and the details of the technology reported in Table 1 are suitable for producing fuel under laboratory circumstances.

3.2. On the base of the summarized data given in Table 2, the physical and chemical features of the produced fuels can be evaluated. Otherwise the aim of the transesterification is to approach the characteristics (density, viscosity, flash-point, iodine number, acid number) of biodiesels obtained from various biomasses, to those of diesel gasoils only by slight transformation. The Hungarian standard plan MSZ/T 2056 contains the allowable limits and values concerning biodiesel production. It has to be noted, however, that currently there is no legal biodiesel production in Hungary. Comparing the data of Table 2 with the values included in the standard plan, it can be seen that all of the characteristics of the fuels produced in laboratory (G1-G6) are under the limit values of the standard plan, except cold filter plugging points. However, the required value of this property can be adjusted by applying additive in low level. Although the samples G7-G9 for themselves are not convenient for diesel engines, blended with diesel gasoils in a certain concentration they may be suited for this purpose. This means that there is no disqualifying reason regarding the use of these materials in diesel engines.

In the following we show three examples from the results of the engine tests:

3.2.1. In the case of applying biodiesel, the effective power output and the maximum torque of the engine was in every case lower compared with the values obtained with diesel fuel. The decrement equals with that gained by running the engine with methyl ester produced of pure plant oil. This means that the decrement is between 4 and 7 percent. Figures 1/a, 1/b, 1/c and 1/d show examples for this statement.

3.2.2. By examining the indicator diagrams belonging to the individual load points, it can be stated that engine characteristics of various plant oils are very close to each other. This means that the energy contents of esters of different types scarcely differ from each other, and their burning and heat evolving properties are very similar, too. Analysing the area of

the maximum pressure in an appropriate enlargement, it can be seen that there is very little difference between the peak pressures obtained with various materials. Nevertheless the value of the maximum pressure has only small effect on the area below the curve, that describes the engine work. The maximum difference between the peak pressures in terms of the percent of the highest pressure is about 10 %, and this causes the 4-7 % decrease of the effective power output. Figures 2 and 3 show two examples for the indicator diagrams.

3.2.3. The various types of fuels can be characterized by the components of emitted exhaust gas. It is a common experience that quantity of the components of the emitted gases is more favourable when the engine is running with plant oils than it is if diesel oil is burning. Values of the CO, CO₂ and C_nH_m components were better in every experiment carried out with plant oil compared to diesel oil, but there were no significant differences. Comparing the components connectable to biodiesel fuels, the dispersion was about 10 %, but the soot content of exhaust gas showed a big diversity. This appeared as visible smoke only at r.p.m.-s near the maximum torque. In some cases the emitted soot represented about ¼ parts of the amount obtained with conventional diesel fuels at the same load point. Figures 4 and 5 show two examples for the components of exhaust gas.

4. Evaluation of the results suggestions

The final establishments are following:

- Plant oils and animal fats used in households are capable for use as engine fuels after suitable discontinuous transesterification
- All of the esterified versions of coincidentally collected materials shown as examples fulfilled the regulations of the standard MSZ/T 2056 regarding to the examined parameters
- Decrease of the power output of the Perkins engine applied in the tests was between 4 and 7 %.
- The concentration of deleterious substances in the biodiesel exhaust gases was unambiguously more favourable than in the case of conventional diesel fuels, especially as to the soot emission, representing in some cases about ¼ part of the amount obtained with conventional diesel fuels. This means at the same time that visible soot was only observable when the engine was highly overloaded.

For elimination of used frying oils which are dangerous wastes, an alternative method can be their use as engine fuels after transesterifying.

References

- [1] Enguidanos M. - Soria A. - Kavalov B. - Jensen P., (2002).: Techno-economic analyses of Bio-alcohol production in the EU: a short summary for decision makers. Joint Research Centre, European Commission, Brussels, 34 p.
- [2] Enguidanos M. - Soria A. - Kavalov B. - Jensen P., (2002).: Techno-economic analyses of Bio-diesel production in the EU: a short summary for decision makers. Joint Research Centre, European Commission, Brussels, 33 p.

- [3] Nye, M.J., T.W. Williamson, S. Deshpande, J.H. Schrader, W.H. Snively, T.P. Yurkwich and C.L. French, (1983): Conversion of used frying oil to Diesel fuel by transesterification. Preliminary test. J. Amer. Oil Chem. Soc. 60:1598.
- [4] Mittelbach, M. and P. Tritthart, (1988): Diesel fuel derived from vegetable oils, III. Emission tests using methyl esters of used frying oil. J. Amer. Oil Chem. Soc. 65: 1185-1187.
- [5] Mittelbach, M., B. Pokits and A. Silberholz, (1992): Production and fuel properties of fatty acid methyl esters from used frying oil. Conference of Liquid Fuels from Renewable Resources, Nashville, Tennessee, 1992. In: Proceedings of an Alternative Energy Conference, p.74-78.
- [6] Jánosi L., Ess D.R., Gibson H.G. (1996): Reducing Harmful Diesel Emissions By Using Rapeseed Methyl Ester Fuel. International Conference on Air Pollution from Agricultural Operations, February 7-9, 1996, Kansas City, Missouri, USA. In: Conference Proceedings, p.175-182.
- [7] Jánosi L., Józsa N. (1999): Növényi eredetű hajtó és kenőanyagok összehasonlító vizsgálata, különös tekintettel a koptató hatására. Előadás. MTA AMB K+F, Gödöllő, 1998. I. 20-21

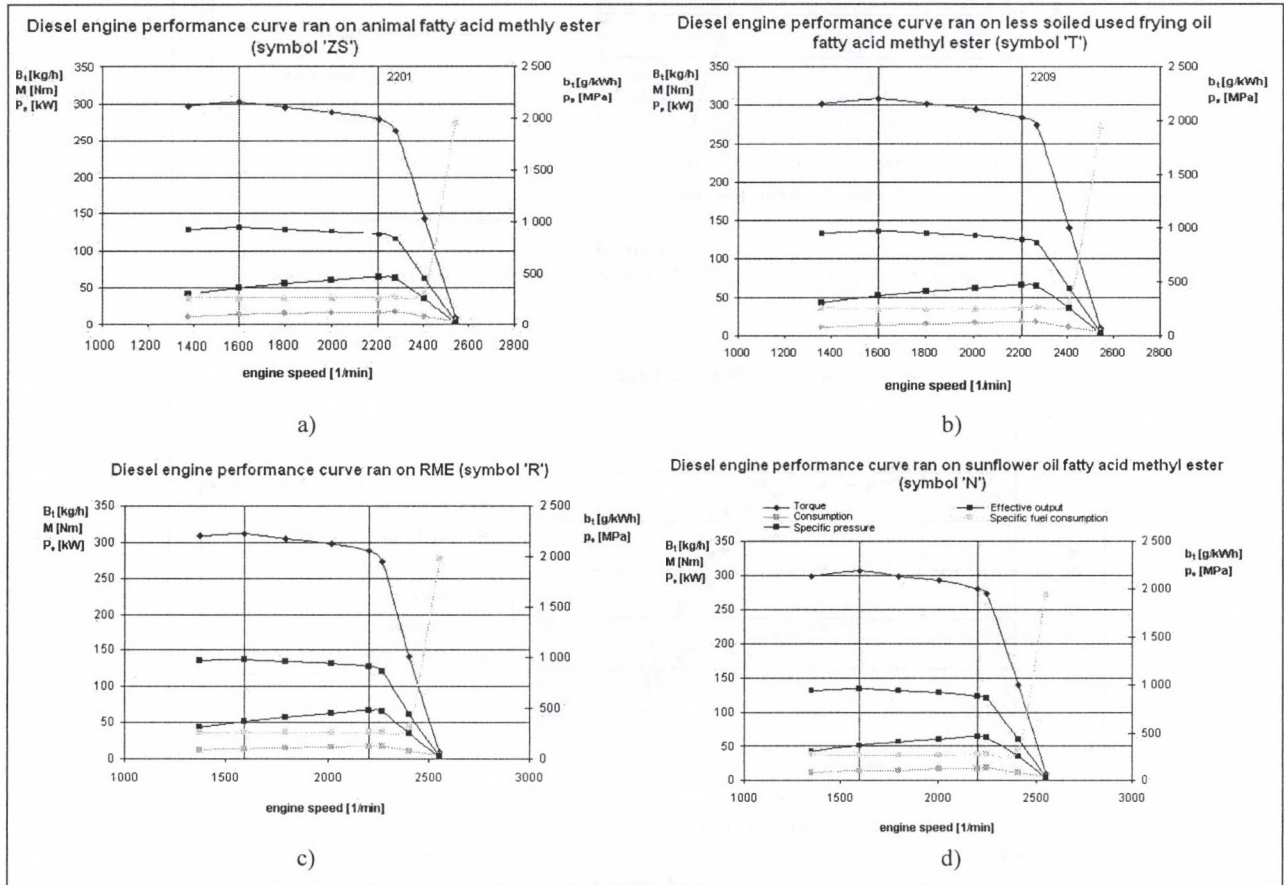

Figure 1

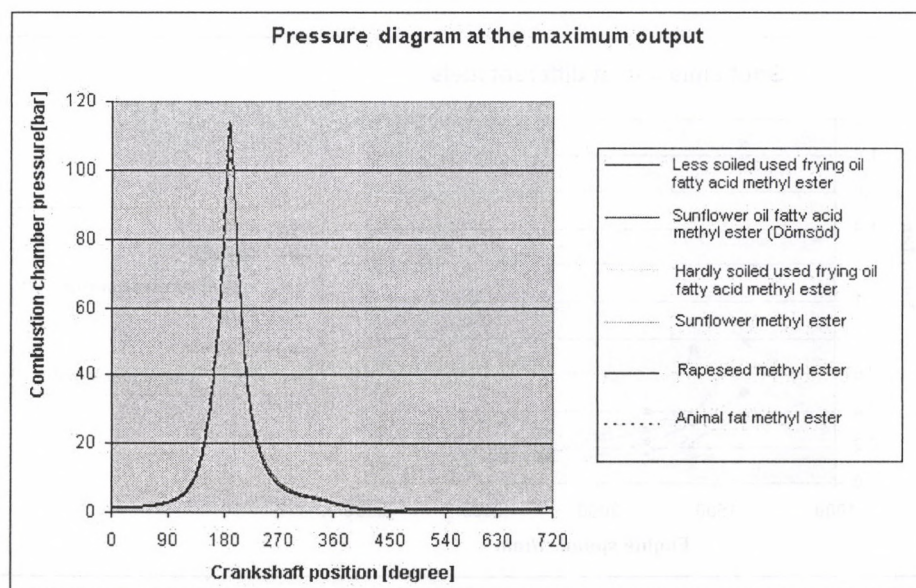
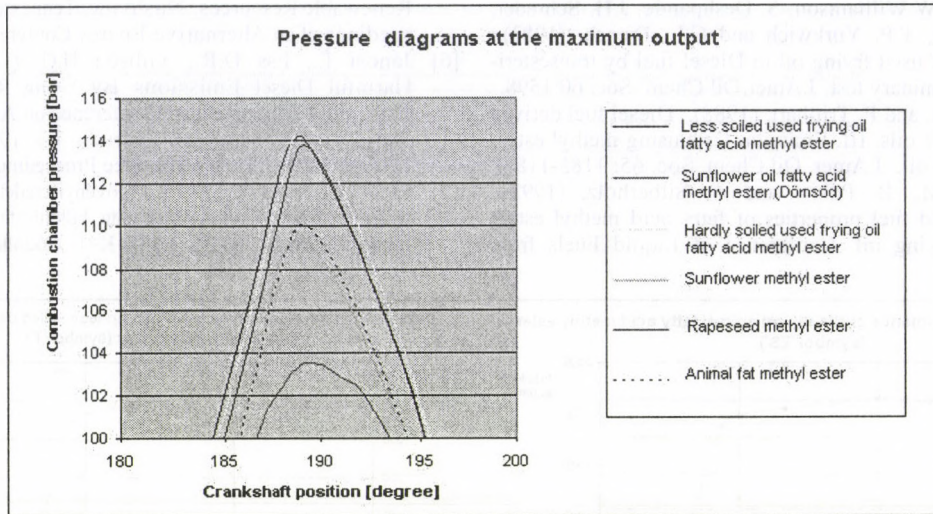
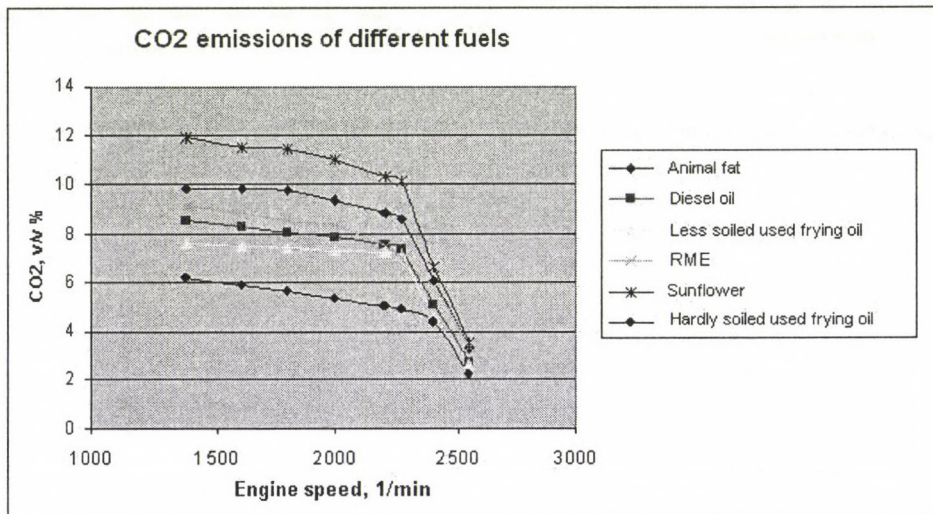

Figure 2

Spread indicator diagrams belonging to the maximum output



Enlargement of the peak of the spread indicator diagrams belonging to the maximum output



Changing of the CO₂ emission at maximum load ran on different kinds of fuels

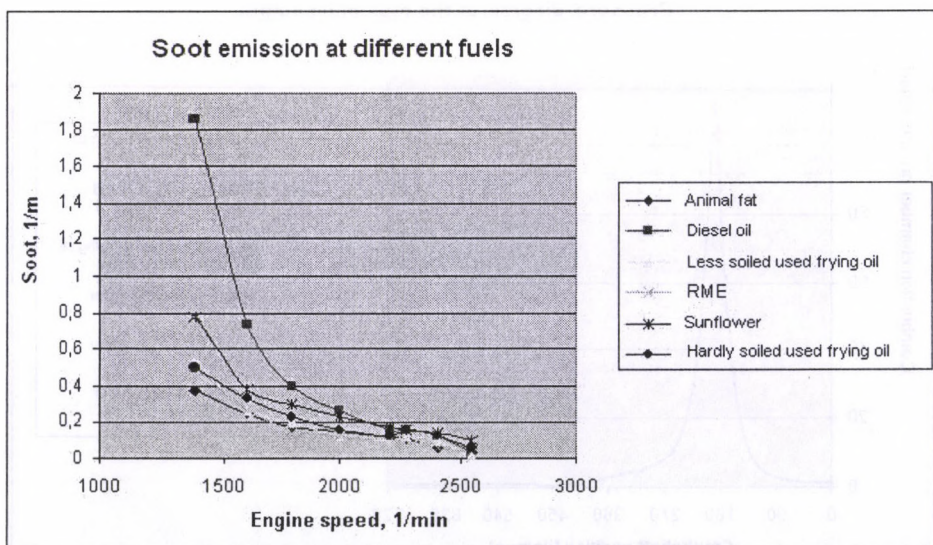

Changing of the carbon black emission at maximum load ran on different kinds of fuels

RENEWABLE ENERGY FROM HAZARDOUS ORGANIC WASTE

K. Kovács^{1,2} – I. Kalmár³ – Z. Bagi^{1,2} – P. Valastyán⁴,

¹University of Szeged

²Institute of Biophysics, Biological Researcher Center, Hungarian Academy of Sciences, Szeged

³Tessedik Samuel College, Mezőtúr

⁴Unicotech Kht., Szeged

Antecedents

In Hungary the number of slaughter pigs is 10 times less than in Netherlands, but the concentrated pig farms produce environmentally hazardous waste. The leakage of organic waste into the environment and into the ground water supply represents a public health concern as well. Anaerobic digestion (AD) offers an environmentally and economically feasible solution to the waste treatment difficulties.

The pig manure – as many organic materials – is transformed into inorganic substances, which are plant nutrients, and during the bioconversion biogas is produced from the organic materials. The biogas is a methane-rich fuel, which contributes to the environmental difficulties because of the glasshouse effect. At the same time, the methane content of the biogas may be a renewable energy source in the future.

Aims, tasks

The general aim of the project is to demonstrate the benefits of the complex exploitation of available resources, to improve the local situation, as well as to generate the knowledge base for a high-tech energy and biotechnology industry. The proposed integrated technological system will develop a mixed biogas/natural gas based power plant network. This will support energy consumption during peak usage periods, contributing to the economically and environmentally friendly energy diversification of the region.

The aim of the project to maximize the biogas production using large scale experiments under field conditions.

The tasks performed:

- design of the experiments
- design of the toolkit
- the functional check of the toolkit
- experiments under various technological parameters

Results

The amount of biogas formed from the different organic waste and liquid manure is affected by many factors: the physical and chemical composition of the liquid manure, the temperature of the fermentation, the microbiological treatment, the content of the bacterium culture, the ratio of the additive organic materials, the ratio of the carbon and nitrogen. Another important influential factor is the mode of the fermentation: continuous or periodic.

After a thorough survey of the literature we established that the fermentation period of the 1-5 % dry matter content suspensions is 10-30 days with 50-65 % efficiency. The control experiments demonstrated, that the biogas production of the fermentors (filled with liquid manure) drastically decreased after two weeks. Accordingly, we planned our experiments time period for two weeks. At different temperatures distinct microorganisms take part in the anaerobic digestion process, therefore we performed the experiments in mesophilic (28-32°C) and thermophilic (53-55°C) temperature zone. In the comparative experiments the following additives were used: sewage sludge, sugar, sawdust, and bacterium culture. Continuous and the periodic fermentation were also compared. The feeding volume of the substrate was 1/14 part of the fermentor volume (continuous fermentation).

During the experiments four fermentors were used, each having a useful volume of 50dm³. The toolkit contained an electrical water heating system, so it was possible to carry out the experiments in both the thermophilic and mesophilic temperature zones.

The effects of additives on biogas production

At the beginning of the experiments the fermentors were filled with liquid pig manure, the additive materials were added to the system. The amount of biogas formed was measured with gas-meter.

The conditions of the experiments:

- fermentation temperature: 53-55°C
- duration of the comparison: 14 days
- additive materials:
 1. fermentor: sugar (10 %)
 2. fermentor: sewage sludge (10 %)
 3. fermentor: bacterium (10 %)
 4. fermentor: control

The amount of biogas formed in the fermentors is shown at the first figure.

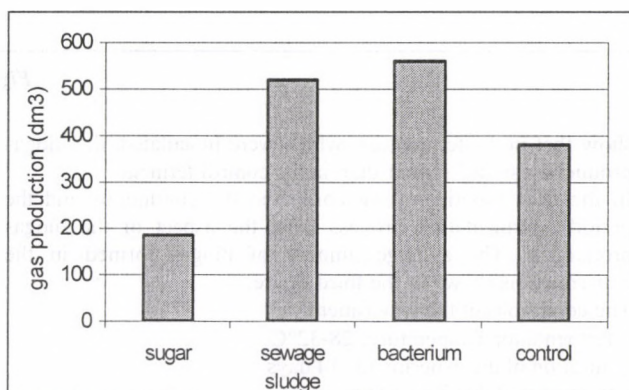

Figure 1

The results of the experiment show that the fermentation of the organic materials found in pig manure is faster using a suitably selected bacterium strain, the activity of the methanogen strains is increasing soon. If the fermentor was inoculated at the peak period of the gas production the fermentation time of the liquid manure decreased.

In the next experiment the common effect of the additive materials was examined:

1. sewage sludge (10 %), sawdust (10 %)
2. sugar (10 %), sawdust (10 %)
3. sewage sludge (10 %), sugar (10 %), sawdust (10 %)
4. sewage sludge (10 %), sugar (10 %), bacterium (10 %)
5. sewage sludge (10 %), bacterium (10 %)
6. sugar (10 %), bacterium (10 %)

The experiments were carried out in two periods using control fermentors. The largest amount of biogas was measured in the fermentors, which contained sewage sludge, sugar and sawdust as an additive material, less biogas was measured in the fermentors, which contained sugar, sawdust and sewage sludge and sawdust. The experiments show that using additive materials brings about advantageous effects for the metabolism of the microbes taking part in the anaerobic digestion process. The highest biogas production was achieved in the fermentor, which contained the highest concentration of organic material in a unit volume.

In the next experiment the fermentors were inoculated with a suitably selected bacterium strain. The amount of biogas formed per day is shown in the second figure. The experimental results

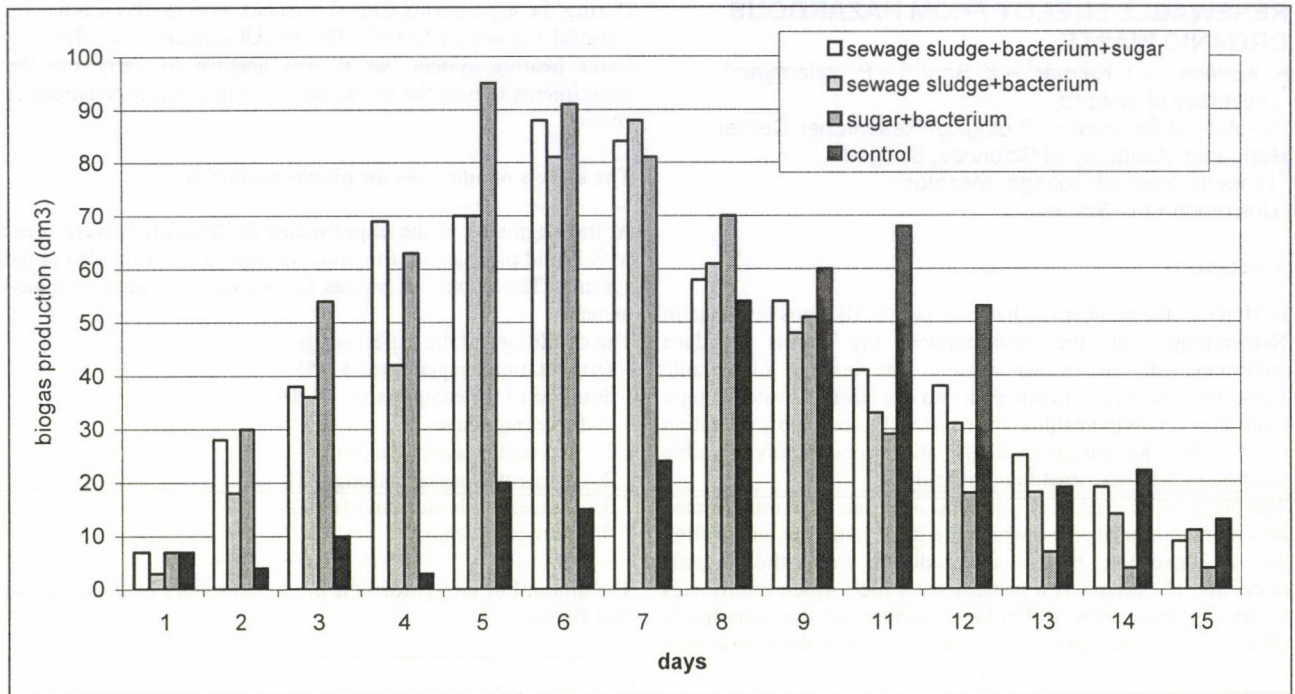

Figure 2

show that in the fermentors, which were inoculated, the biogas production started sooner than in the control fermentor.

In the next experiment we compared the continuous and the periodic fermentation process from the aspect of the biogas production. The average amount of biogas formed in the experiment is shown in the third figure.

The conditions of the experiment:

- fermentation temperature: 28-32°C
- duration of the experiment: 14 days
- treatment of the fermentors

1. fermentor: control
2. fermentor: inoculation
3. fermentor: refill with 7,5 % liquid manure per day
4. fermentor: inoculation, refill with 7,5 % liquid manure per day

The biogas production varied significantly. Using refilling technology (fermentors number 3. and 4.) the amount of biogas formed was twice large as using periodic technology (fermentors number 1. and 2.). The biogas production in the periodic technology increased after microbiological treatment (fermentor number 2.) compared to the control fermentor (fermentor number 1.)

In summary, the results of the experiments suggest that biogas production from liquid pig manure is possible under mesophilic and thermophilic conditions. The amount of biogas formed from the liquid pig manure is influenced by the technological parameters and the additive materials. These experiments are shown that it is important to carry on further studies in the field of the biogas production.

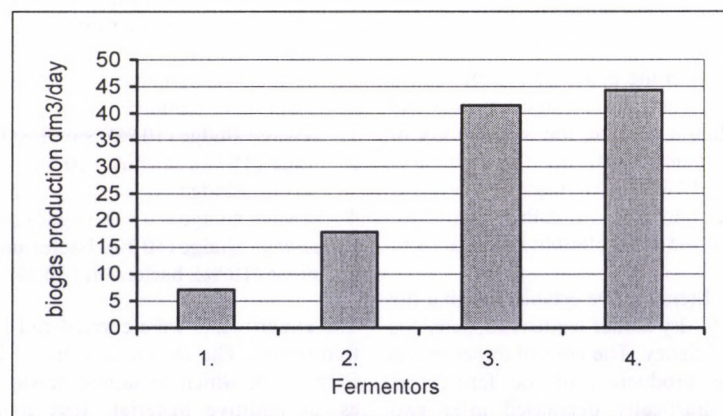

Figure 3

DOMESTIC EXPERIENCES OF OPERATING WIND GENERATORS

L. Tóth¹ – G. Horváth¹ – G. Tóth² – N. Schrempf² –

L. Fogarasi¹

¹Szent István University, Gödöllő

²Ph.D. student

Introduction

According to the requirements of the European Union, Hungary has to increase the energy that can be obtained from the renewable energy resources in a significant measure. One of the most obvious solutions can be the much wider utilization of the wind energy for producing electric energy to be fed in the cross-country power network. **Recently – in the case of reasonable preferences – the economical utilization of the wind energy is a real possibility i.e. the projects will be recovered.** To achieve this, the state aids are required that can be obtained at present and should be got also in the future – in the way of tenders for it – and the advantageous environmental effects of the “green energy” must be included into the purchase prices.

Preliminaries

During the establishment of the domestic wind generators worked out till now – apart from the financial and technical realization – it had to fight against the prejudice asseverated by some persons as “there is not enough available (recoverable) wind energy in Hungary”. However, the researchers emphasized that only some regions of the country are distinct considering the wind-course i.e. the north-west part is advantageous. An example contradicting this is the wind power station established in Kulcs as it is located inside of the country far away from the those regions that can be considered to be a potentially suitable place as e.g. the area of the Little Plain.

There is a legislation rule in Hungary that the electricity suppliers are obligated purchase the energy produced from renewable energy resources if the power of the established equipment is higher than 100 kW.

Material and method

Nowadays the investors demand the results of long-term (at least one-year) energetic wind measurement at the height of minimum 20 and 40 m (or at bigger height) for assuring the certain returns of the wind power station. The measurements are important especially because of the diversified topographic conditions and mainly because of the determination of the friction and the wind profile (Figure 1) or the turbulence.

The measurements were carried out with the help of instruments and methods applied in the European practice. There are several statistic distribution functions suggested for the data processing to describe the wind distribution.

Knowing the average value of the wind speed, the frequency of wind velocity concerning a given spot can be determined with the help of Rayleigh's distribution function with suitable approximation.

Relative velocity v of the wind:

$$f(v) = \frac{\pi \cdot v}{2 \cdot v_a^2} \cdot e^{-\frac{\pi}{4} \left(\frac{v}{v_a}\right)^2} [\%], \text{ where } v_a \text{ is the average wind velocity}$$

velocity

On the base of the measurements carried out during 12 months and taking into consideration the meteorological measurement data of 10 years in the region, we gave the prognosis for the choice of the generator and the expectable energy production.

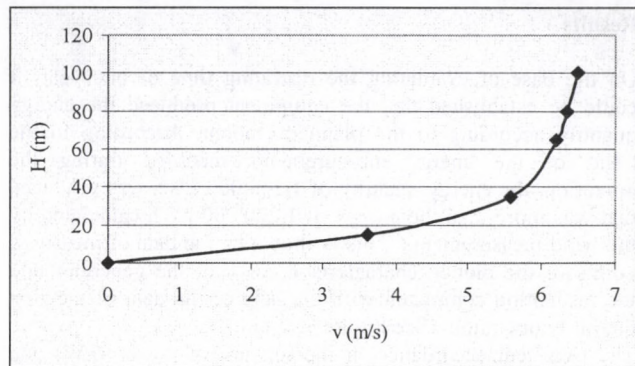

Figure 1

The wind profile in Kulcs (on base of measurements at the height of 15 and 35 m)

The main properties of the equipment chosen for the so called continental wind conditions measured in Kulcs are demonstrated in Table 1 and 2.

Table 1 Main properties of equipment

Type:	Enercon E-40
Nominal power:	600 kW
Diameter of the blade-wheel:	44 m
Height of column:	65 m
Wheel-blade:	The angle of blade position can be changed.
Number of blades:	3
R.p.m.:	18 to 34 min ⁻¹
Generator:	Multipolar (so called annular) generator type ENERCON
Connecting to the power-circuit:	With frequency converter type ENERCON
Wind direction homing:	With active hydraulic driving unit of constant pressure independent of r.p.m. setting the generator down the wind
Starting wind speed:	2,5 m/s
Nominal power:	At the wind speed of 12 m/s
Regulation system:	Electronic (ENERCON SCADA)

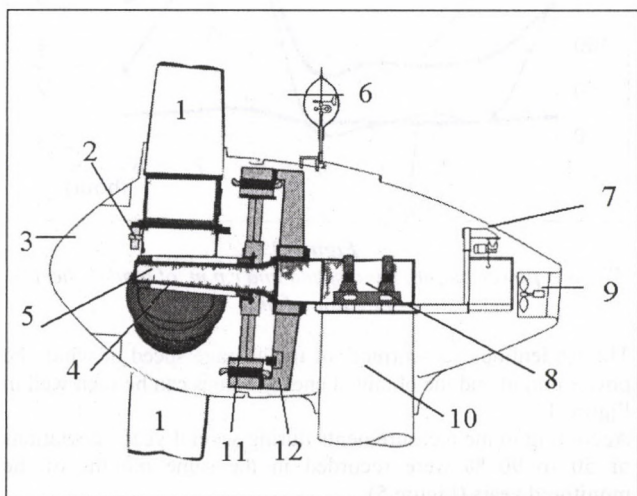

Figure 2

Construction of the power nacelle

1 – blade, 2 – blade-rotating motor, 3 – case, 4 – shaft, 5 – bearing, 6 – speed and direction anemometer, 7 – crane for lifting parts, 8 – catch of shaft, 9 – cooling fan, 10 – column, 11 – generator-rotor, 12 – generator-stator

Results

On the base of evaluating the operating time of one year, it could be established that the equipment produced the energy quantity according to the planned amount. According to the trend of the energy measurements recorded during the operation, the energy quantity of 1,245,000 kWh was produced that was more than the energy of 1,220,000 kWh calculated by the wind measurements. This is shown by the data of measured points of the plotted characteristic curve of the generator and the evaluation completed with the help of the data of the first quarterly operation. (See Figure 3, 4 and 5.)

The excellent accordance in the relation of power (kW) and wind speed (m/s) can be seen in the diagram (Figure 3) while the r.p.m. of the rotor (min^{-1}) changes at a relatively low degree.

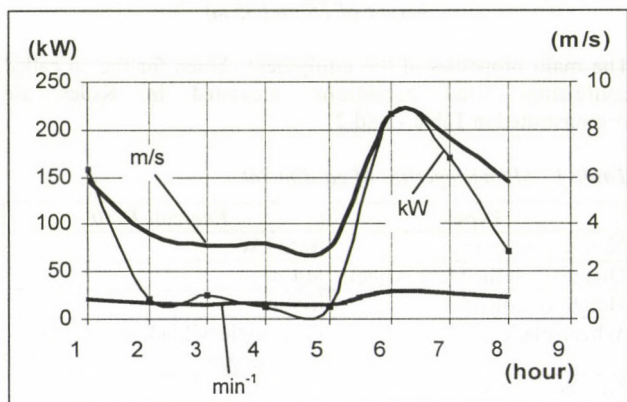

Figure 3

Electric power output, wind speed and r.p.m. of blade-wheel in function of time

The excellent accordance in the relation of power (kW) and wind speed (m/s) can be seen in the diagram (Figure 3) while the r.p.m. of the rotor (min^{-1}) changes at a relatively low degree.

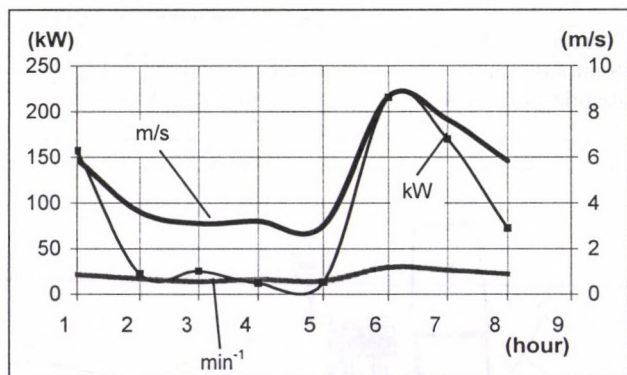

Figure 3

Electric power output, wind speed and r.p.m. of blade-wheel in function of time

The tendentious "co-current" of the average speed of wind, the power output and the obtained energy values can be seen well in Figure 4.

According to the measurements during several years, deviations of 50 to 90 % were recorded in the same months of the monitored years (Figure 5).

There is not significant deviation between the power values of the power stations of same type operating in the two different

spots of the country in the case of suitable choice of place. Only the shift in time can be experienced according to the frontal passages (Figure 6).

Conclusions

The accurate measuring of the local wind energy is basically important because of the topographic forms and the conditions of the Carpathian basin before establishing a project of enterprise in Hungary to built a profitable power station (generator) obtaining energy from wind. These measurements have to be carried out with the help of calibrated instruments and at high reliability and software or algorithm elaborated on the base of wide experiences because the cost to be invested in each unit of equipment of 600 to 1000 kW is between 160 and 220 million HUF. The investment cost of a wind farm including 15 to 25 generators (with units of 1.0 to 2.0 kW) is between 5.0 and 7.0 milliard HUF. The return of the considerably high investment costs (economical operation or use) can be expected only if the location in the given place is the most optimal and the energy extraction values are the best.

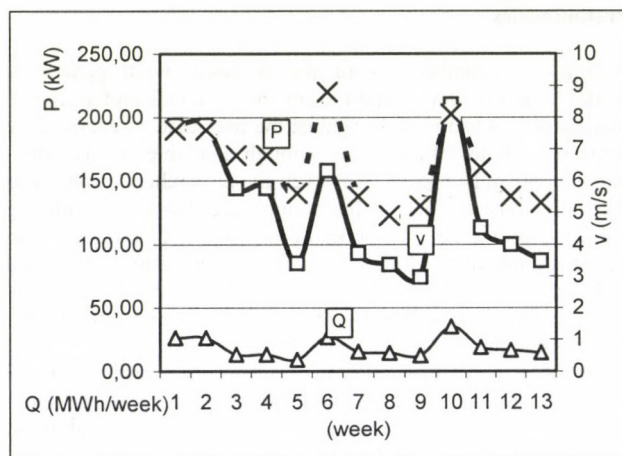

Figure 4

Measurement data of 14 weeks at operating wind power station

*P – average value of weekly produced energy,
Q – summarized weekly produced energy,
v – weekly average values of wind speed*

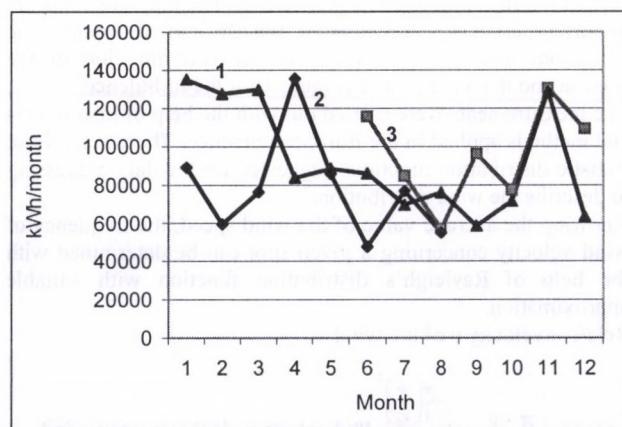

Figure 5

Energy production of the power station in Kulcs during 25 months (1 – 2002, 2 – 2003 and 3 – 2001)

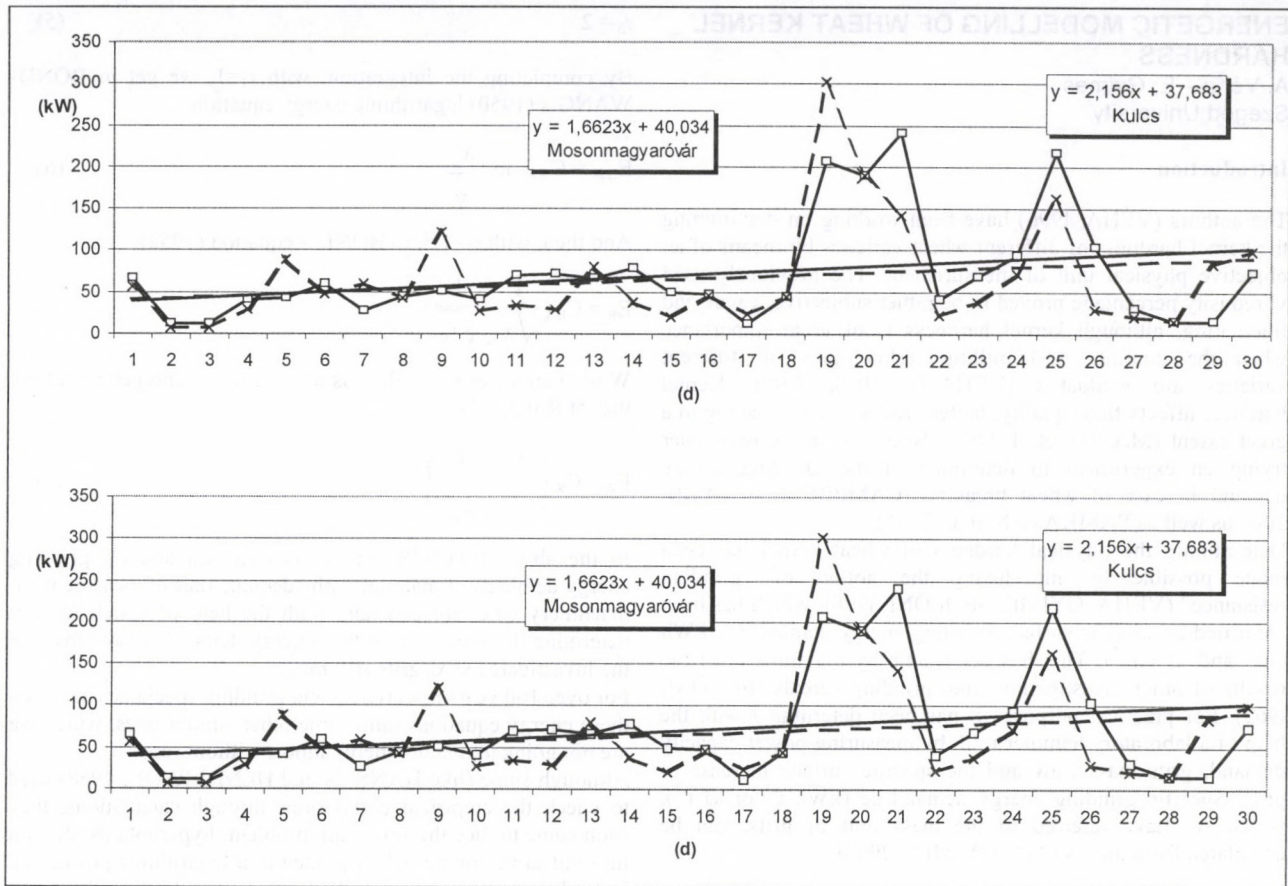

Figure 6
 Power characteristics of the stations operated in Kulcs and in Mosonmagyaróvár at a distance of 200 km from Kulcs north-westward (Equipment type E-40 in both cases with the nacelle-height of 65 m)

ENERGETIC MODELLING OF WHEAT KERNEL HARDNESS

A. Véha – E. Gyimes
Szeged University

Introduction

The authors (VÉHA, 1996) have been working on determining the kernel hardness of different wheat varieties by means of an objective physical unit of measurement. The previously used vitreosity percentage proved to be rather subjective, vague and fluctuating, although kernel hardness is of great importance when the qualities and milling technologies of different varieties are evaluated (VÉHA–GYIMES, 1999). Kernel hardness affects flour quality, batter production and baking to a great extent (MATUZ et al. 1999). Nowadays more researcher trying an experiment to determine of the grinding energy demand in case of wheat breaking (CAMPBELL – WEBB, 2001 as well as PASIKATAN et al, 2001).

Determining the physical hardness of wheat kernel has been made possible by introducing the notion of "grinding resistance" (VÉHA–GYIMES–BÖLÖNI, 1998), which has been identified as specific surface grinding energy demand (e_f : kWh cm⁻² and kJ cm⁻²). This has been done by making use of the results of other investigations into grinding cereals (BÖLÖNI, 1962). For practical purposes it has been determined with the help of a laboratory hammer mill, by measuring power capacity demand, grits mass flow and the specific surface increase of grits. Specific grinding energy demand e_d (kWh t⁻¹ or kJ t⁻¹), which we have referred to the mass unit of grits, can be calculated from this (VÉHA–GYIMES, 2000).

Antecedents of grinding energetics

Although the exploration of the main energetic regularities of grinding goes back to the 19th century (RITTINGER, 1867), a differential equation of general use can only be first found in the book written in 1937 by WALKER-LEWIS-MCADAMS-GILLIAND, according to which

$$dE = \frac{dx}{x^r} \quad (1)$$

where:

x = grain size of a supposedly homogenously distributed set
 dx = its infinitesimal decrease in the initial phase of grinding
 dE = energy demand of the above mentioned size decrease
 r = parameter characteristic to the grained material, machine e.t.c.

To put it in words, this equation says that the energy needed to decrease the diameter of size x grains by dx is inversely proportional to grain size and its r -th power. This hypothesis therefore postulates a hyperbolic relation between specific grinding energy demand and grit fineness (grain size) in general.

After integrating equation (1) we get to energy demand

$$E = \int_{x_0}^{x_1} \frac{dx}{x^r} \quad (2)$$

where:

x_0 = initial size before grinding and x_1 =decreased grain size (diameter) after grinding.

As for the values of r parameter in the denominator, CHARLES (1957) made the following supposition:

$$r_1 = 1 \quad (3)$$

$$r_2 = 1.5 \quad (4)$$

$$r_3 = 2 \quad (5)$$

By completing the integration, with $r_1=1$, we get to BOND-WANG's (1950) logarithmic energy equation

$$E_{BW} = C_{BW} \cdot \ln \frac{x_0}{x} \quad (6)$$

And then, with $r_2=1.5$, to BOND's equation (1952)

$$E_B = C_B \left(\frac{1}{\sqrt{x}} - \frac{1}{\sqrt{x_0}} \right) \quad (7)$$

While parameter $r_3=2$ takes us to the earliest energetic relation, that of Rittinger's:

$$E_R = C_R \left(\frac{1}{x} - \frac{1}{x_0} \right) \quad (8)$$

In the above (6),(7),(8) equations C_{BW} , C_B and C_R grinding energy demands of material with adequate unit of measurement, machinery e.t.c. are constant, with the help of which we can determine the specific grinding energy demands of the mass in the investigated $x < x_0$ grits size range.

For over 100 years researchers and grinding specialists accepted these energy equations (and some other similar ones, which we are not going to mention here) almost without reserve.

Although some (like HANSEN and HENDERSON, 1968) tried to check the empirical correlations through calculations, they soon came to face the following problem: hyperbola (8) did not turn out to be simple; when plotted in a logarithmic power net, instead of exponent $n = 1$ they got $n_B = 1.16$ for wheat and $n_K = 1.33$ for maize in $\bar{x} = 1.3 \dots 4$ mm average grain range.

In 1991 BÖLÖNI and CSERMELY checked the three most important energy equations (6),(7),(8) by measuring hammer milled barley grits.

Their series of experiments yielded an unexpected result; although the average size of whole grains was only $x_{og}=3.4$ mm before milling, Rittinger's hyperbola

$$e_d = \frac{11,262}{x} - 2,314 \quad (9)$$

intersected the horizontal, grain size axis at $x_{og}=4.87$ mm (well above real size). This proved that a simple hyperbola cannot be used to describe the energetic equation sought for.

BÖLÖNI and BELLUS's further investigations in 1998, and the introduction of binary energetic functions revealed where the problem had originated from, which our ancestors cannot have been aware of. The establishment of equation (8) indirectly includes the earlier unknown fact that specific surface, which is inversely related to \bar{x} (cm) average grain size,

$$a = \frac{6}{\rho x} \text{ (cm}^2 \text{ g}^{-1}\text{)} \quad (10)$$

that is the cubic and spheric shape modelling of grains is only valid for individual grains or for sets of homogenous grain size, each particle of which is the same size ρ [g cm⁻³] density of grit set).

Equation (10) is not valid for the mean specific surface (a_d) and (a_d) of many average grain sizes derived from grain size distribution (analysis), that is

$$\bar{a}_d \neq \frac{6}{\rho x} \quad (11)$$

Since grain distribution is oblique and theoretically lognormal, the number of fine grains (and the proportion of their specific

surfaces) increases, and the number of coarse grains (and their specific surfaces) decreases. The degree of this increase is expressed by c.o. (coefficient of obliqueness) introduced by the authors, which is always more than 1 (c.o.>1) for grits.

For hammer-milled barley we got numerical data (D-12 and D-24) c.o.=1.49...1.77, while the size distribution of whole barley kernels proved to be normal. Thus c.o. is approximately 1 because of the balance of fine and coarse grains.

Formula (11) complemented with c.o. coefficient of obliqueness for grits:

$$\frac{a_d}{\rho \cdot \bar{x}_d} = \frac{6(c.o.)}{\rho \cdot \bar{x}_d} \quad (12)$$

Since c.o.=1,

$$\bar{a}_{og} = \frac{6}{\rho \cdot \bar{x}_{og}} \quad (13)$$

remains true for grain sets where \bar{x}_{og} = average (mean) grain size.

BÖLÖNI and BELLUS's binary energetic model, published in 1999, where e_d (kWh t⁻¹) specific grinding energy demand is not only related to \bar{x}_d average grit size but also to e_f (kWh cm⁻²) specific surface grinding energy demand, says

$$e_d(e_f, \bar{x}_d) \quad (14)$$

In full expansion

$$e_d = \frac{6 \cdot 10^6 \cdot e_f}{\rho} \left[\frac{c.o.}{\bar{x}_d} - \frac{1}{\bar{x}_{og}} \right] \quad (15)$$

Where:

ρ = grain density (g cm⁻³)

6 = constant resulting from the supposed cubic shape of grains

10⁶ = conversion factor deriving from the chosen units of measurements

Departing from equation (15) it is not difficult to assume that the average specific surface of grits (cm² g⁻¹) is

$$\frac{6 \cdot (c.o.)}{\rho \cdot \bar{x}_d} = \bar{a}_d$$

and that the specific surface of whole grains before grinding (cm² g⁻¹) is

$$\frac{6}{\rho \cdot \bar{x}_{og}} = \bar{a}_{og}$$

Thus

$$\frac{6 \cdot (c.o.)}{\rho \cdot \bar{x}_d} - \frac{6}{\rho \cdot \bar{x}_{og}} = \bar{a}_d - \bar{a}_{og} = \Delta a_d \quad (16)$$

that is the specific surface increase of grits.

Conclusion

The mathematical model of kernel hardness is the next:

by leading equation (16) back to (15) we get

$$e_d [\text{kWh t}^{-1}] = 10^6 e_f [10^{-7} \cdot \text{kWh cm}^{-2}] \cdot \Delta a_d [\text{cm}^2 \cdot \text{g}^{-1}] \quad (17)$$

Consequently e_f is the "grinding resistance" characteristic to kernel hardness, that is specific surface grinding energy consumption is the mathematical model of kernel hardness, where e_d and Δa_d are independent variates (see equation 18).

$$e_f = \frac{e_d}{\Delta a_d} [\text{mWh cm}^{-2}] \quad (18)$$

e_d (kWh t⁻¹) specific grinding energy consumption ("impact energy" in mechanical technology) expresses one of the physical characteristics of milled material; it shows how much energy causing permanent deformation can be transmitted to a crop of certain variety and state (e.g. true to variety wheat) with a mill of given kinematic and geometric parameters, that is how much impact energy the material can absorb.

Δa_d (cm² g⁻¹) specific surface increase indicates the fineness and composition of the grits we get from the given wheat variety with the above mentioned (e_d) specific grinding energy input. This is the other physical and mechanical feature of the variety. **Our model demonstrates it clearly that e_f (mWh cm⁻²) "grinding resistance" is a new physical feature dependant on two (e_d , Δa_d) characteristic data.**

Acknowledgements

The authors would like to express their thanks for the Széchenyi István Grant they were awarded, without which it would not have been possible to carry out their research.

References

- Böloni I. (1962): A kalapácsos daráló üzem állapotát meghatározó jellemzők összefüggései. MGI Közleménye, Mezőgazdasági Kiadó Vol. VIII., N° 8, pp. 1-71
- Böloni I. - Bellus Z. (1998): Kétváltozós energetikai függvények kísérleti igazolása. XXVII. Óvári tudományos Napok, Mosonmagyaróvár, Vol V., pp. 1056-1061
- Böloni I. - Csermely, J. (1991): A RITTINGER, KICK és a BOND-féle aprítási elméletek kísérleti összehasonlítása. Járművek, Mezőgazdasági Gépek, Budapest Vol. 38. N° 12 pp. 471-474
- Böloni I. - Bellus Z. (1999): Contribution to the Verification of the Two-Variable Energetic Function. Hungarian Agricultural Engineering Gödöllő, Vol. 12. pp. 75-77.
- Bond, F.C. (1952): The Third Theory of Comminution. Mining Engineering, Trans AIME, 193 pp. 484-494
- Bond, F.C. - Wang J.T. (1950): A New Theory of Comminution. Mining Engineering, Trans AIME, 187 pp. 871-878
- Campbell, G.M. - Webb, C. (2001): On predicting roller milling performance Part I: the breakage equation Powder Technology Vol.115 (3) pp: 234-242
- Charles R.J. (1957): Energy Size Reduction Relationships in Comminution. Mining Engineering, Trans. AIME, 208 pp. 80-87
- Hansen R.C. - Henderson S.M. (1968): Farm Grain Comminution: Hammer Mill and Burr Mill Performance Analyzed. Transactions of ASAE, St. Joseph pp. 399-402
- Matuz, J. - Markovics, E. - Ács, E. - Véha, A. (1999): Őszibúza-fajták lisztjének technológiai minőségi tulajdonságai közötti összefüggések vizsgálata. Növénytermelés. Vol 48 (5) pp. 243-253
- Pasikatan, M. - Milliken, G. - Steele, J. - Haque, E. - Spillman, C. (2001): Modeling the energy requirements of first-break grinding Transaction of the ASAE. Vol: 44 (6), pp.1737-1744
- Rittinger P.R. (1867): Lehrbuch der Aufbereitung Kunde (Textbook of Mineral Dressing), Ernst & Korn, Berlin
- Véha, A. (1996): Aestivum búzák szemkeménységének újszerű meghatározása. MTA-MÉTE-KÉKI 279 Tudományos Kollokvium, Budapest Abstract in Élelmezési Ipar, Vol. L., N° 12 p. 378.
- Véha, A. - Gyimes, E. - Böloni, I. (1998): Különféle búzafajták szemkeménységének vizsgálata az aprítási ellenállás mérése alapján. GATE-FM Műszaki Intézet, Gödöllő, Vol. II. pp. 25-30.
- Véha, A. - Gyimes, E. (1999.): Investigation of Kernel Hardness in Winter Wheat Varieties with Hammermill. Cereal Research Comminutation Szeged, Vol. 27. No.4 pp. 463-470.
- Véha, A. - Gyimes, E. (2000): Determining Kernel-hardness Through the f Kernel Hardness in Winter Wheat Varieties with Granulometric Parameters of Grinding. Hungarian Agricultural Engineering Gödöllő, Vol. 13. pp. 29-31.

INFLUENCE OF LOAD ON THE FRICTION COEFFICIENT BETWEEN STEEL AND POLYAMIDE ROLLING COUPLES

R. Cotetiu¹ – A. Cotetiu¹ – O. Eberst¹ – G. Kalácska²

¹North University of Baia Mare, Romania

²Szent István University, Gödöllő

Introduction

All over the world, the preoccupation of replacing metallic materials with other types of materials has widely spread. Within the Machine Manufacturing Department, this fact has determined preoccupation oriented towards the replacing and observing in operation metallic components of technological equipment with components of non-metallic materials. Out of the trends adopted, the present paper shows research carried out, having as objective the study of variation of friction coefficient values at the steel-polyamidic material rolling couple in relation to the variation of load applied, under different lubrication conditions.

The rolling couple under experiment is represented by the following elements: bearing races made of different polyamidic materials, on which bearing metallic balls roll.

Non-metallic materials used are ERTALON 66 SA and ERTALON 66-GF -30 polyamides, provided by the joint research project between the universities.

The shape of the bearing race profile is rectilinear. Rolling is done without lubrication, with lubrication with T90 EP2 STAS 8960-85 oil type and lubrication with glycerin.

The diameter of bearing balls, made of bearing steel RUL3 STAS 1456-80, with diameters of 7,13 mm. The condition imposed to the balls is that the set under test be in the same dimensional group, with the objective to undertake the load equally by all balls in contact.

Device for the study of rolling friction

Experimental installations having as object the study of friction are made up of the following common elements: support, driving system into relative motion of the friction couple element, system of normal force application, system of friction force measurement. In the case of the stand used (fig.1), the components are the following:

- Support that fixes the two elements of the friction couple, being materialized through a device in which the bearing races are. This device also allows the change of test pieces under experiment.
- Driving system for relative motion of the friction couple elements is done manually, by the dynamometer;
- The system of normal force application is made up of a plate on which graded weights are placed;
- Measurement system for friction force is represented by the dynamometer of the dynamometer system, which are mounted in parallel. To orientate the dynamometer on the direction of the friction force, this moves in a guide.

The stand allows the necessary calibration to precisely obtain the friction force (ex: Placement on a co-linear direction with the direction of tangential force).

Conditions and experiment manner

For each constructive variant the following operations have been carried out:

- Measurement of test piece roughness under experiment;
- Grading a control of dynamometers;
- Placement of test piece fixing device on a horizontal support;
- Checking the fixing of test pieces in the device;

- Positioning dynamometers in guide;
- Lubrication of bearing races (if the test is done on lubricated surfaces);
- Application of load progressively to values established on the plate and the reading of friction force at the driving into motion of the system.

Experimental results and interpretation

The study of friction coefficients for the three materials under testing was done taking into account load variation, lubrication status of surfaces. For all test pieces used, roughness was determined and the profile graph on the direction of rolling was plotted. We have observed deviations from rectilinearly at the test pieces, fact that can lead to local variation of pressure on contact due to loading differences of rolling bodies.

The geometrical deviations of the rolling surface can determine the occurrence of situations in which in the identified area being mostly with rolling motion, on portions there might be mostly sliding motions. The values of the Rz roughness of bearing races are:

- For ERTALON 66 SA: working traces parallel with the Rz 1,6 μm rolling direction; traces perpendicular on the Rz 6,3 μm rolling direction.
- For ERTALON 66-GF 30: working traces parallel with the Rz 0,8 μm rolling direction; traces perpendicular on the Rz 6,3 μm rolling direction..

Roughness value determination was done at the beginning of measurements. On rolling under load, roughness values underwent changes due to plastic deformations of roughness edges up to the creation of the balance state between the force applied on the contact area and the flow characteristic of the material. The applied load varied between 9,81N and 350 N. The diameter of balls used: 7.13 mm. The number of balls that undertook load: 20. Surface lubrication status: dry, lubricated with mineral oil.

Influence of the load variation

Analyzing the behavior of the friction coefficient on dry surfaces, along with load increase we observe an increase of its value with very small loads, increase explained by the predominance of sliding in balls motion on bearing traces. This fact can be better observed at materials with different elastic constants. With the continuous increase of load, the value of the friction coefficient decreases for a certain loading field. This fact is explained by the gradual replacing of the predominant sliding motion with a predominant rolling motion, as well as by roughness change through plastic deformations taking place at the level of the contact area, for the balance status between load and the flow characteristics of friction couple materials. In the evolution of the friction coefficient curve in relation to load, there is an optimum, after which its value tends to slightly grow. This growth is explained through the plastic deformations of the materials and the losses through hysteresis. All studied materials exhibit this behavior, some of them having the decrease of coefficient value smaller or even nil, the area being marked by a flat area in the evolution of the variation curve.

As a general statement for dry friction is the decreasing evolution of the friction coefficient, the maximum values being measured in the inferior part of the loading area.

Influence of the bearing race materials

Bearing on races made of polyamidic materials has led to the decrease of friction coefficient value for the load domain in which the experiment took place. The minimum values of the friction coefficient were obtained for bearing races of Ertalon

66 SA, with processing traces parallel with the rolling direction. The variation of the friction coefficient in which bearing races are made of polyamidic materials meets the general tendency above mentioned for dry rolling/bearing. In the situation of rolling on lubricated races, the evolution is continuously increasing for the case of Ertalon 66-GF30 (fig.2,3,4,5.).

Conclusions

Analyzing experimental results, the following can be concluded:

1. On dry surfaces load increase leads to an increase of the friction coefficient value, at small loads.
2. On dry surfaces, at heavy loads, the friction coefficient decreases for a certain loading domain. This fact is explained by the gradual replacement of the predominantly sliding motion with a predominantly rolling motion, as well as through roughness changes through plastic deformations that take place at the level of the contact area, to establish the balance between load the flow characteristics of the friction couple materials.
3. In the evolution of the friction coefficient curve in relation to load there is an optimum (a value minimum) after which its value tends to increase slightly. This increase is explained by the phenomena of elastic deformations of the materials and the losses through hysteresis and the adhesion phenomena.
4. The general behavior presented at points 1,2,3 is of all the studied materials, some having the coefficient value decrease lower than zero, the area being marked by a flat portion in the evolution of the variation curve. As a general statement for dry friction of rolling is the decreasing evolution of the friction coefficient, the maximum values being measured in the inferior part of the loading domain.

5. The minimum values of the friction coefficients were obtained for the bearing races of Ertalon 66 SA, with processing traces parallel with the rolling/bearing direction.

Acknowledgement

The research was supported by the cooperation agreement of the SZIE Gödöllő and NU Baia Mare and OTKA T 042511 found.

References

- [1] Cotețiu, R.: Cercetări și soluție constructivă pentru îmbunătățirea comportării tribologice și creșterii randamentului la angrenajele melcate necilindrice. Teza de doctorat. Universitatea Tehnică din Cluj Napoca, 1998.
- [2] Cotețiu, R., Cotețiu, A.: Cercetări teoretice și experimentale privind influența sarcinii asupra evoluției randamentului angrenajului melcat cu corpuri de rostogolire. Buletinul Științific al Universității de Nord, seria C, vol.12, Baia Mare, 1998, p. 55
- [3] Cotețiu, R., Cotețiu, A.: Stand pentru studiul randamentului angrenajelor melcate. Buletinul Științific al Universității de Nord, Seria C, vol.12, Baia Mare, 1998, p. 61.
- [4] Kalácska G.- Zsidai L.- Kozma M.- DeBaets P.- Vercammen K.: Tribology research of engineering plastics by different tests. Bulletin of the Szent István University. Gödöllő 2001-2002. p 119-127
- [5] Kalácska G.- P. De Baets. Tribological research of up-to-date, environment-friendly self-lubricating materials: correlation between large scale and small scale tribotesting Int. Conf. On Machinery, May. 2002, Budapest (Hungary)

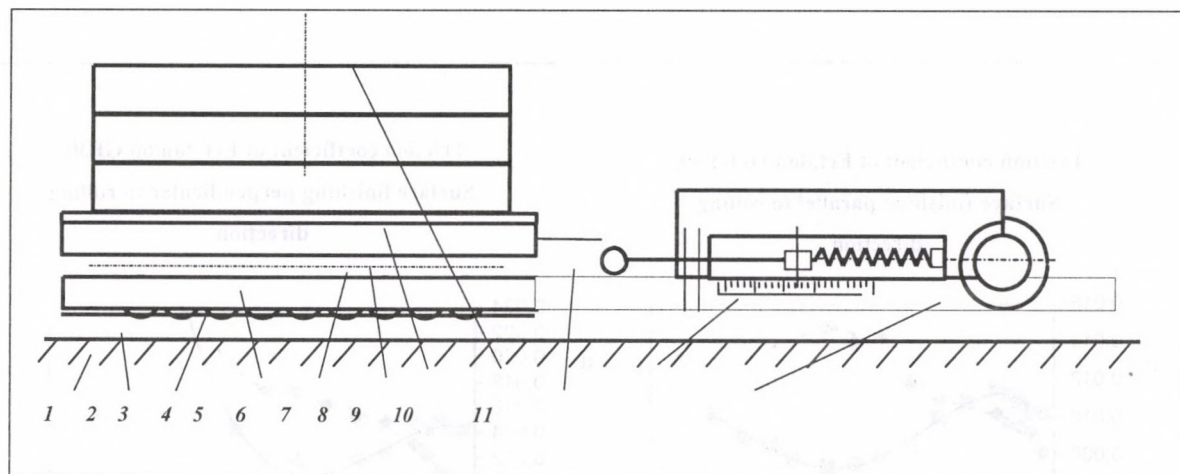
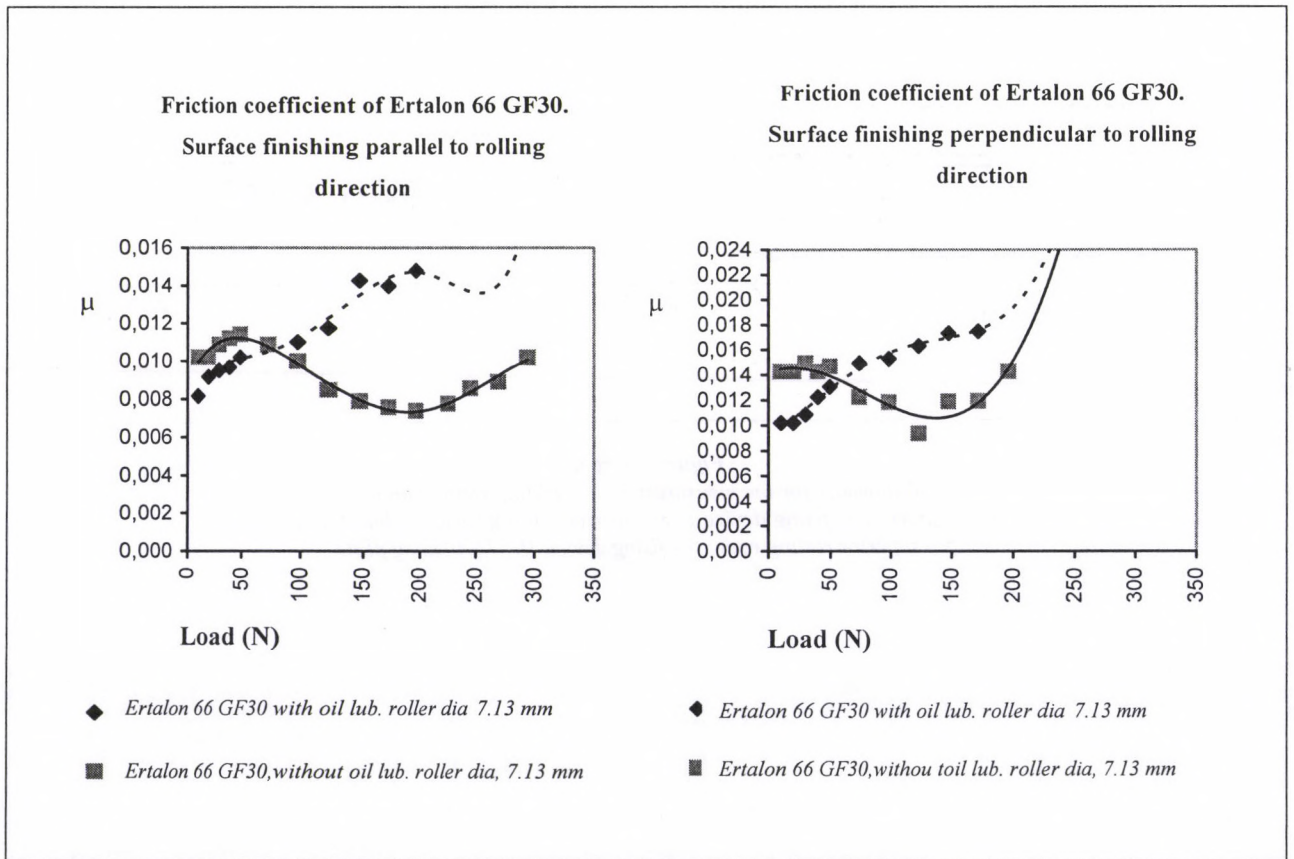
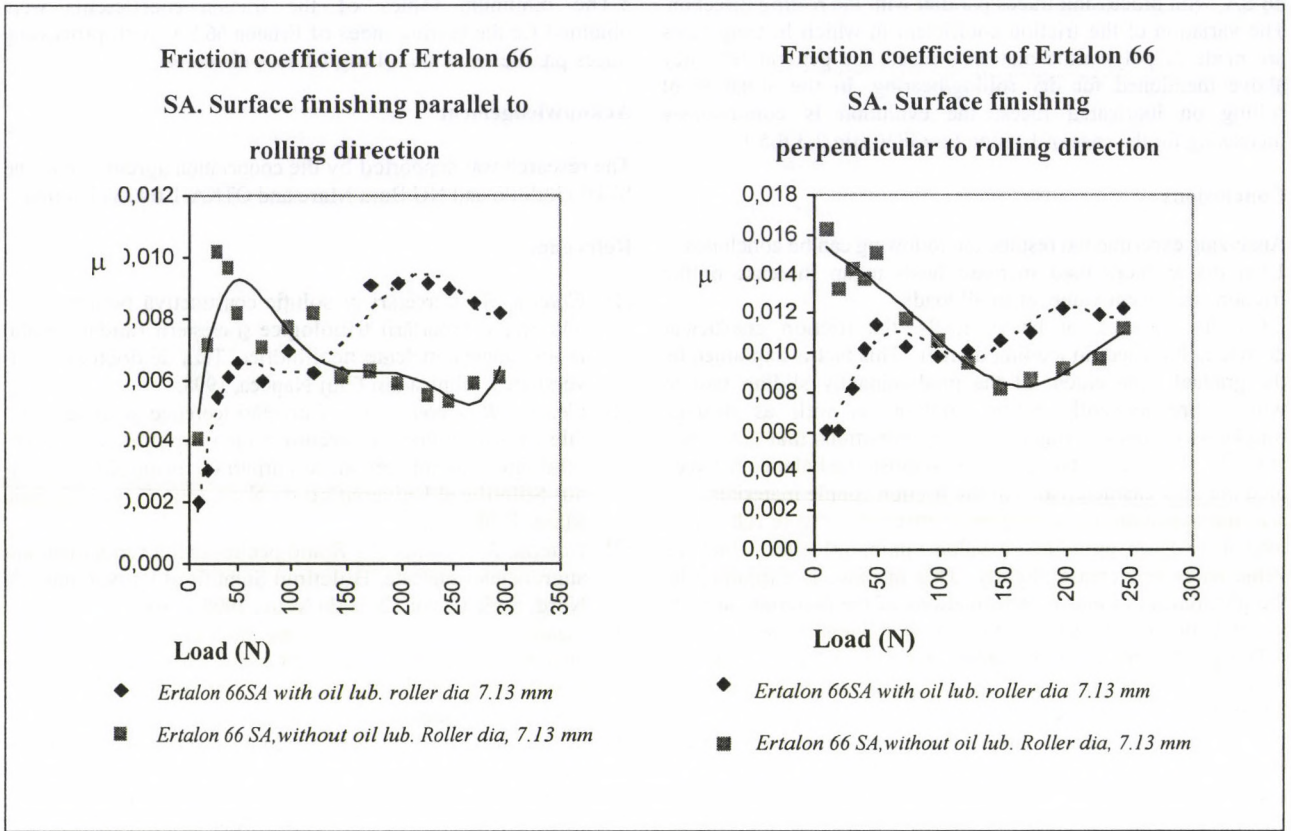

Figure 1 Testrig

Tribometer for the measurements of rolling friction force

- 1 – support; 2 – fixing device I; 3 – inferior rolling race; 4 – ball train;
5 – superior rolling race; 6 – fixing device II; 7 – loading plate



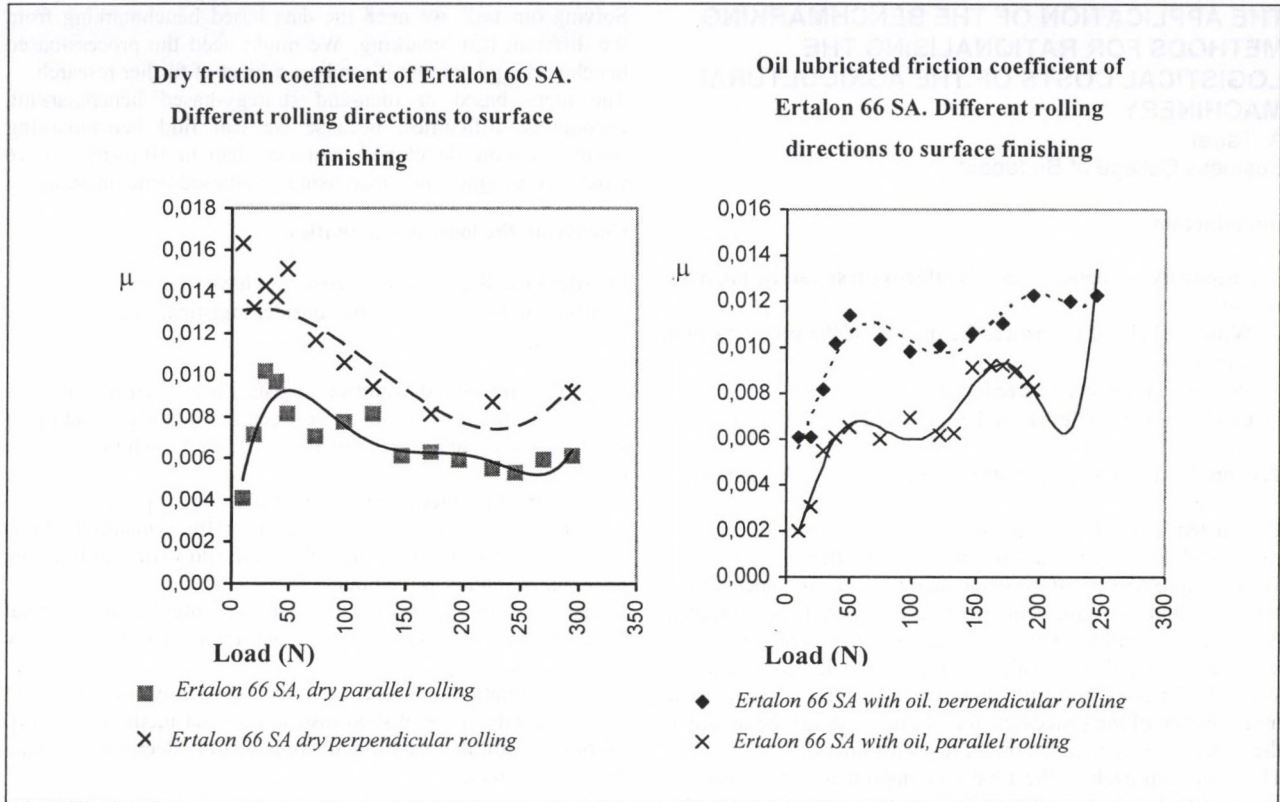

Figure 4
Rolling friction of Ertalon 66SA (different lubrication)

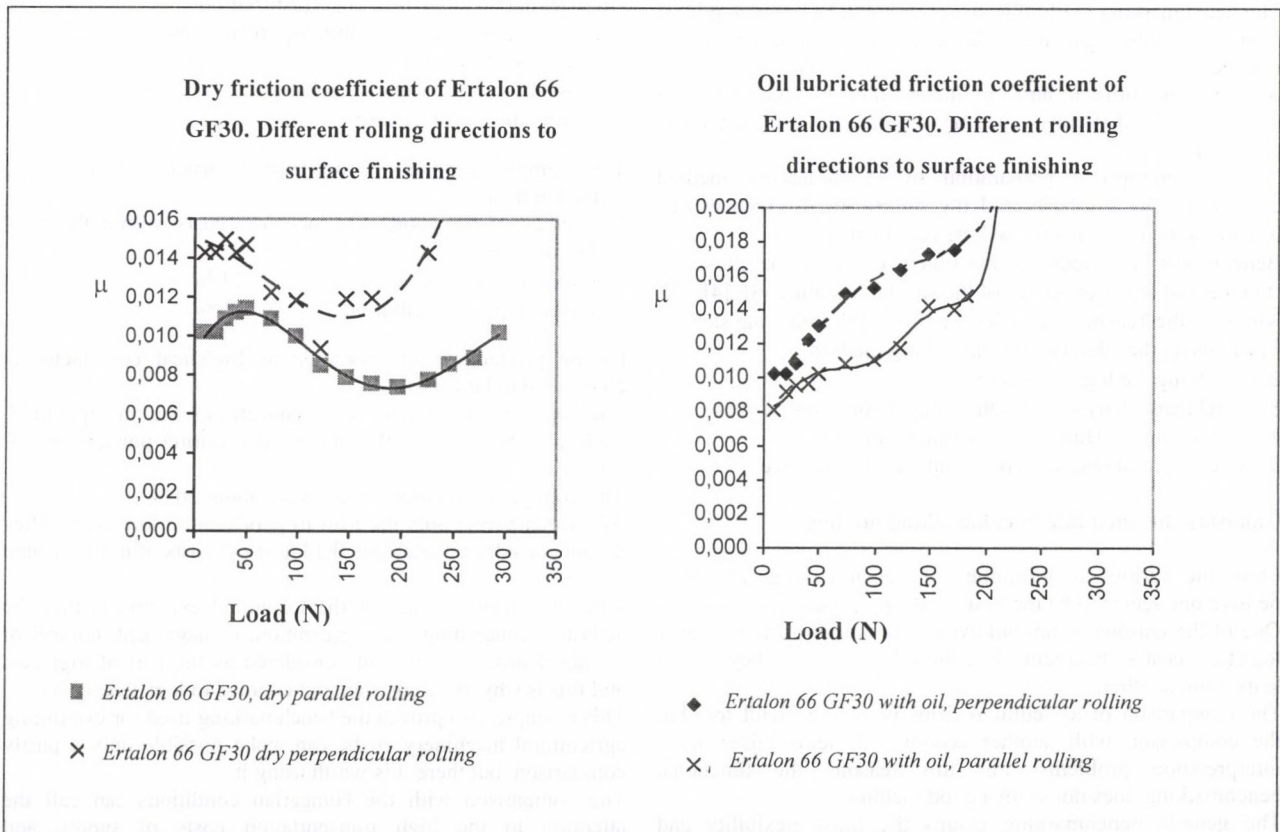

Figure 5
Rolling friction of Ertalon 66GF30 (different lubrication)

THE APPLICATION OF THE BENCHMARKING METHODS FOR RATIONALISING THE LOGISTICAL COSTS OF THE AGRICULTURAL MACHINERY

A. Tátrai

Business College of Budapest

Introduction

The necessity of logistics and its effectiveness can be proved in various ways.

- With the help of Logistics, the quality of the product can be improved
- Production costs can be reduced
- Customer service level can be improved

The production (supply, distribution) processes become more transparent.

The listed (and here not mentioned) results can only be successful if they are not detrimental to each other.

When improvement of product quality and customer service level resulted in significant increase of costs, it is ambiguous that it can be reflected in the price of the product. In case of keeping the number of sales, production will produce losses. When logistics costs result in diminution of total costs or better transparency of the processes, they cannot change the quality of the product, since then we might lose customers.

The right approach is the total cost approach, which makes it possible to demonstrate that increasing logistics costs can effect cost reduction at other fields.

It is practical to examine the costs of utilization of agricultural machinery with the benchmarking method in order to optimize logistics' costs.

To demonstrate logistics costs, we can compare national results to other countries' by the benchmarking method.

The benchmarking method is useful as it can be applied quicker than elaborating new methods, since it is based on others' experience.

At the same time it has big inconvenience: comparing the results can be difficult sometimes because of different interpretations.

Without appropriate preparation of benchmarking method discovering the similarity and the significant divergences, the interpretation of the results will be very misleading.

Benchmarks of agricultural machinery costs can be chosen in statement of logistical costs of the special literature [3], [4], [5]. Knowing the benchmark we have to make the following steps:

- 1) Choosing the adequate benchmarking method
- 2) Clarifying the logistical activities
- 3) Benchmark analyses from the comparison point of view
- 4) Preparation for Hungarian measurement
- 5) Assessment of result, recommendation for practice

Choosing the adequate benchmarking method

From the various opportunities of benchmarking, the competitive one seems to be the best for the purpose.

One of the reasons is that not even a Hungarian firm has better logistical costs statement, than the other ones, so they cannot learn from another.

The comparison of agricultural firms is very difficult too, but the comparison with another economical fields raises again interpretation problems. For this reason the functional benchmarking does not seem a good method.

The generic benchmarking claims the most flexibility and creativity. As having the possibility to make comparison within the agriculture, it is not necessary to choose the most difficult way.

Solving our task, we need the data based benchmarking from the different benchmarking. We might need the process-based benchmarking later, but it can be a subject of further research.

The men- based or men-and strategy-based benchmarking encounters difficulties, because we can find benchmarking mainly in more developed countries than in Hungary, so we would have higher costs than using data-based benchmarking.

Clarifying the logistical activities

In order to analyze logistical costs, we have to clarify

- what kinds of costs can be considered logistical ones
- how can we measure them

Generally in most of countries logistics are taken in a narrow sense: only the flow of goods between the factories, loading of goods, warehousing, and sometimes the same activities within the factories.

Accepting the interpretation of Halaszne [1] we have to consider the processes of planning, controlling, management as parts of logistical ones, including the flow of information, documents, money and labour.

Because of this problem the data of international special literature can be compared with our own measurement only very circumspcctly.

In the international special literature practically measured and estimated data are published instead of exact methods. [3], [4]. So our possibilities are limited: we have to collect our own data by the same methods.

Benchmark analyses from the comparison point of view

In the international special literature the agricultural logistical costs are demonstrated in the following classification [3]:

Before production logistical costs /related to purchasing

Production's logistical costs

After production logistical costs distribution

Machinery cost structure within logistical costs:

- Transportation's costs
- Costs of manipulation's machinery
- Information Science costs

The example examined is from French horticulture, containing estimated data.

Percentage of transportation logistical costs within the total logistical costs:

- during purchasing 29 %
- during supply/distribution 32 %

During production transportation as logistical cost factor is considered to be very low.

The logistical machinery cost concerning the manipulation, packaging, loading are the highest also during purchasing and supply.

The average information sc. costs are about 20 %.

All this data refer only the flow of goods and information. They do not consider for example the logistical costs of move of men power.

The same insufficiency of the examined example is that the activities concerning the organization, management, control of logistical processes are not considered as the part of logistics, and this is why these costs are not counted to logistical costs.

This example also proves the benchmarking used for examining agricultural machinery costs, can make possible only a partly comparison, but there it is worth using it.

The comparison with the Hungarian conditions can call the attention to the high transportation costs of supply and distribution, which set up a claim to having more modern of vehicle, better organization of traffic, more favourable fuel consumption.

We can draw the same essential lesson from the comparison of costs of machinery used in the stocking, warehousing and packaging. It is very important to note that this machinery costs can be decreased only by supply of modern, more profitable machinery costs, but also by better organization of working. If the information science costs are lower in our country it can mean that fewer working processes are controlled by computer and it decreases the profitability of the production (supply, distribution).

Preparation for Hungarian measurement

We have no standard method for measuring logistical cost in our country neither. The information concerning the research of product cost and income do not include the logistical costs. More precisely these costs are named differently that could be counted as logistical ones.

The bigger problem is that the costs of logistical activities counted under another costs can not be separated.

In case of the comparison we have to collect the international data according to the same methods as the benchmark was received. As it was, the international data of special literature are from the information of agriculturists and from estimations.

This is why we need data from the Hungarian firms of our research. Getting information we have to consider two angles:

- we have to collect data from the same areas as it was in case of benchmark in order to the comparison
- we have to ask for data of activities out of the base of the benchmark research if they are perceives in our point of view to be important for the complete examination of the logistical costs.

On the data collecting sheet it is not necessary to name the examined activities as logistical ones, since probably they are not known by these names to those who provide the data. However we have to make an effort to group the costs in case of getting them the data according to our research.

For example researching the agricultural costs and income data [2] ,[6] the following costs are presented: maintenance costs, tractor costs, combine costs, irrigation costs, desecrator desecrator costs, auxiliary costs. However we need the following grouping:

- machinery costs of purchasing
- machinery costs of production
- machinery costs of supply

Assessment of result, recommendation for practice

Before comparison we have to separate the data into comparable data and another data.

Making comparison we have to be sure if the data refer really to the same area and comparable conditions of the benchmark.

The results of comparison have to be well visible.

The reason of the difference has to be examined.

The benchmarking method can have positive effects only if the examination is followed by clarification of experience, indicating of tasks and making the necessary steps.

References

- [1] Halászné dr.Sipos Erzsébet: Logisztika. (LFK, Magyar Világ Kiadó.1998.)
- [2] Kertész Róbert: A társas vállalkozások fontosabb ágazatainak költség- és jövedelemhelyzete a kilencvenes években (Agrárgazdasági információk 2000. 6.szám)
- [3] J - C.Montigaud, J-M.Ferry : La logistique, un outil stratégique privilégié de la grande distribution. Montpellier (Série Études et Recherches No102. 1995.szept.)
- [4] J - C.Montigaud : EUROTOM (Marmande, 1995.dec 1-30)
- [5] Munson Charles L., Rosenblatt Meir J., Rosenblatt, Zehava: Use & Abuse of Power in Supply Chain, Business Horizons, 1999 jan -febr.)
- [6] A fontosabb élelmiszeripari termékek 1999.évi költség és jövedelemadatai (Agrárgazdasági információk 2000.4. sz.)

THE POTENTIALS AND LIMITATIONS OF JUST IN TIME (JIT)

J. Benkő
Szent István University, Gödöllő

Introduction

The classical production management systems ensure continuous production by acquisition and building of stocks. Although stockpiling provides security for the organisation, it is also well known that more security means more expenditure. The task of stock management, therefore, is to establish a balanced system that is both reasonably secure and financially viable.

There is other solution for the problem when we do not increase the stock levels, but rather reduce the insecurities of the production in both input and output sides and in the production itself. In theory, in case of appropriate supply sources and infrastructure, it is possible that secure production can be achieved by a few hour stock-level. This is the so-called Just In Time (JIT) system which is often referred to as stock management without stock or stock management without storehouse

The objective of the JIT system is to ensure delivery and/or arrival of materials and products at the right place, at the right time. Theoretically, it can result in "zero stock" which does not allow of delivery failures. Subsequently, one of the neuralgic points of JIT is delivery. We can summarize the changes in demand towards supply sources in the following way: the size of deliveries decreases, the frequency of deliveries increases, demand for better availability of supply services increases, quality of delivery improves (reliability gets better, probability of product damages diminishes).

Demand for an increasingly efficient supply system will, inevitably, means an increase in cost for organisations wishing to use such services. The question arises whether the reduced cost in stock-keeping justifies or compensates for the increasing cost of delivery services. Unfortunately, managers and decision-makers do not often concern themselves with such questions.

For a proper analysis, one should take into account all the cost factors from dispatch as far as destination, irrespective of, who is the cost bearer, the supplier, the customer or somebody else. If we examine the route a product from the manufacturer to the customer we will encounter the following logistical operations: movement of the product from the manufacture to the warehouse, stock-keeping prior to transportation, loading the product onto the vehicle, transport to destination, unloading the product at destination, movement and stock-keeping until consumption takes place.

Throughout these logistical operations, costs are incurred as a consequence of **movement** (the movement is proportionate with its quantity and distance) and **stock-keeping** (this is proportionate with the stored quantity and the storage period). In this paper, the term **cost of movement** refers to the totality of **costs of materials handling** and **transport costs** (in variance with both the distance of movement and the quantity of material being moved). **Storage cost** consists of **rental** and **stock-keeping** costs. Rental cost amounts to all the costs incurred in storage, including the rent of storage space, the rent of storage machines, the cost of upkeep (for example insurance and the cost of public utility). Stock-keeping (waiting) costs cover the delayed arrival of goods, the locked-up capital and all other losses that are incurred during waiting time.

For analysing the costs Figure 1 depicts the production and the consumption of a product in the function of time. The cumulative quantity of production and consumption varies linearly according to the two parallel lines of (production) and (consumption). The quantity of product (batch of goods) can be determined by mass, volume, piece number, unit etc. The

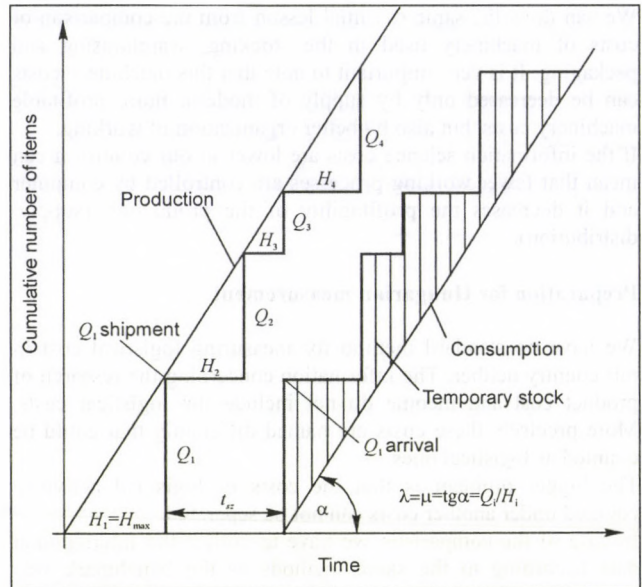

Figure 1
Changes in stock in different logistical phases

direction of the lines is determined by the rate of production (λ) and the rate of consumption (μ) which, as depicted in Figure 1, are equal to one another, therefore $\lambda = \mu = Q_i/H_i$. The stepped horizontal and vertical functions illustrate the time horizons and the quantity of the dispatched and received goods. As the quantity is depicted accumulatively on the vertical axis, it can be clearly seen how much has been produced, transported, received and consumed in a given time frame.

The cumulative functions have been not well-known yet in the theory of stockpiling. These cumulative functions can be easily used in tracking of product lots in the sequential phases of logistics as you can illustrate the change of quantity in different logistical situations (waiting for delivery, transport, waiting for consumption) on one diagram. The vertical section in between the production line and the stepped function on the left hand side represents the quantity of product to be dispatched at a given time. The length of the vertical section relating to the commencement of delivery time represents the quantity of delivered goods. Similarly, at a given time, the vertical sections in between the stepped functions on the right hand side and the consumption line represent the quantity of products to be consumed.

It is also important to understand the horizontal sections of the stepped functions and the areas bordered by the functions. If, within the system, the product quantities flow according to the principles of FIFO, then the i -th product quantity will be equal at each monitoring point. The horizontal section in between the two stepped functions represents the time the product spends moving between those two interdependent points. For instance, the notation t_{sz} on Figure 1 represents the delivery time. The sum of the areas in between the lines and the stepped functions is proportional with the total waiting time of the product quantities. The lined area at the right hand side of the diagram, for example, is proportionate with the time spent at the arrival point of the consumption. The horizontal distance in between the parallel lines of production and consumption depicts the average waiting time between production and consumption. This is the sum of the delivery time (t_{sz}) and the maximum time interval between the dispatches of two consecutive product quantities ($H_{max} = \max\{H_i\}$), that is, the average waiting time:

$$(1) \quad \bar{W} = H_{max} + t_{sz} \quad [\text{hour}]$$

The length of the average cycle, if the number of cycles equals m :

$$(2) \quad \bar{H} = \frac{1}{m} \sum_{i=1}^m H_i,$$

the average dispatched and received amount per cycle

$$(3) \quad \bar{Q} = \mu \bar{H}.$$

The size of storage space (S_{\max}) has to be at least as large as the maximum product quantity (Q_{\max}). In Figure 1 this is represented by the longest vertical section of the stepped functions. Vehicles transport all products manufactured in the given period at the same time; and this is the reason the necessary storage spaces at departure and arrival should be proportionate with H_{\max} and also with the maximum time interval between dispatches, and therefore the required storage capacity is:

$$(4) \quad S_{\max} = Q_{\max} = \mu H_{\max} \quad [\text{piece}].$$

Figure 1 demonstrates that the maximum stock level is identical at the points of order and dispatch.

The above mentioned four cost categories [rental (storage) costs, stock-keeping (waiting) costs, the costs of material handlings and the transport costs] are all related to the maximum stock level and the average waiting time. And then, the notations for average waiting time and maximum stock level can be converted by cost-conversion factors into cost per unit and cost per time dimensions.

Rental (storage) cost

The rental cost comprises the cost of storing space for the maximum stock level and the cost of tools necessary for handling the product. This cost is proportionate to the maximum stock level (S_{\max}). The value of the proportionate factor (c_b) depends on the size of the quantity, the storing requirements and the rental fees. If the buildings and the tools are privately owned (not leased), then the costs of investment varies linearly with the sizes. Knowing the lifetime of the buildings and the fixed assets to be depreciated it is possible to calculate an equivalent rental cost, which is roughly proportionate to the maximum stock level.

The rental cost for one cycle, if c_b [HUF/unit-time] was the specific of rental cost, \bar{H} the length of the average cycle and S_{\max} the size of the storage space:

$$(5) \quad K_b = c_b \bar{H} S_{\max} \quad [\text{HUF}]$$

The rental cost for a time unit:

$$(6) \quad K_{bi} = \frac{K_b}{\bar{H}} = c_b S_{\max} = c_b Q_{\max} = c_b \mu H_{\max} \quad [\text{HUF}/\text{time}].$$

The rental cost per piece number can also be calculated:

$$(7) \quad K_{bd} = \frac{K_b}{\bar{Q}} = \frac{c_b \bar{H} S_{\max}}{\bar{Q}} = c_b H_{\max} \quad [\text{HUF}/\text{piece}].$$

It can be seen from the above relationships that the rental cost per time unit or piece number is proportionate to the maximum time interval between deliveries. Quite simply, if we order more rarely bigger quantities, then stock levels are larger, requiring larger storing space as well. This is one of the reasons why we try to keep stock level as low as possible.

Stock-keeping (waiting) cost

The stock-keeping cost (also referred to as waiting cost) is in connection with the delay of the product and it is based on the

time difference between production and consumption. The specific cost of the stock-keeping for the examined time period (one cycle) is (c_v) [HUF/piece-time], the average period of stock-keeping is ($\bar{W} = H_{\max} + t_{sz}$) and the average stock level is (\bar{Q}), from which the stock-keeping (waiting) cost for one cycle is:

$$(8) \quad K_v = c_v \bar{W} \bar{Q} = c_v (H_{\max} + t_{sz}) \bar{Q} \quad [\text{HUF}].$$

The stock-keeping cost per unit time, if the length of the average cycle is \bar{H} :

$$(9) \quad K_{vi} = \frac{K_v}{\bar{H}} = c_v (H_{\max} + t_{sz}) \frac{\bar{Q}}{\bar{H}} = c_v \mu (H_{\max} + t_{sz}) \quad [\text{HUF}/\text{time}].$$

The waiting cost of one piece:

$$(10) \quad K_{vd} = \frac{K_v}{\bar{Q}} = c_v (H_{\max} + t_{sz}) \frac{\bar{Q}}{\bar{Q}} = c_v (H_{\max} + t_{sz}) \quad [\text{HUF}/\text{piece}].$$

In formula (9) the specific waiting cost (c_v) is multiplied by the piece number $\mu(H_{\max} + t_{sz})$ produced (consumed) during the average stock-keeping time (\bar{W}), while in formula (10) the specific waiting cost (c_v) is multiplied by the time period elapsed between manufacture and consumption. The latter is the same as defined for average waiting time in (1).

Transport and loading costs

For analysing the transport and loading costs adequately, let us take an example. If we entrust a forwarding agent or a carrier with the organisation of the transports, then the transport cost for a given period will equal the total costs of individual transports. The most often used method for the settlement of individual transports is the so called hour-kilometre cost calculation, which is proportionate to the length of transport time and the distance.

$$(11) \quad K_{szf} = c_t (v)t + c_s (v)s \quad [\text{HUF}]$$

where: c_t is hour rate [HUF/hour], t is the time involved in rate calculation, c_s is kilometre rate [HUF/km], s is the distance [km] and v is the capacity of the vehicle [t], [piece], [m³].

The first member of (11) includes the costs of loading and unloading, the cost of wasted and waiting time in connection with the loading and the driver's wage. The c_t [HUF/hour], which is proportionate to transport time, is present in all transport costs irrespective of the cargo content and the distance. The coefficient of the second member (c_s [HUF/km]), the so called kilometre rate, is the specific cost for a unit distance. This member covers all the costs proportionate to the distance, the vehicle performed (maintenance, repair, fuel).

Both c_t and c_s specific costs depend on the delivered quantity, more precisely on the vehicle capacity, which can be depicted with the following linear functions:

$$c_t = c_{t0} + c_{tv} v \quad \text{and} \quad c_s = c_{s0} + c_{sv} v.$$

The constants in the equations are positive numbers, from which follows that the bigger the vehicle is, the larger the specific costs are. (In practice, freight rates are classified according to vehicle capacities and hour rates and the kilometre rates are added accordingly.)

Placing the functions into (11):

$$(12) \quad K_{szf} = (c_{t0} + c_{tv} v)t + (c_{s0} + c_{sv} v)s \quad [\text{HUF}].$$

All variables (time, distance and mass) appear in the transport cost function that influences transportation.

The proportion between the average delivered quantity and the vehicle capacities determines the number of vehicles necessary:

$$n = \frac{\bar{Q}}{v} = \frac{\mu \bar{H}}{v},$$

from which $v = \mu \bar{H} / n$, and the length of time of a round is $t = 2t_{sz}$ (Figure 1.). Replacing them into (12), the cost of a round is:

$$\begin{aligned} K_{szf} &= (c_{i0} + c_{iv} \frac{\mu \bar{H}}{n}) 2t_{sz} + (c_{s0} + c_{sv} \frac{\mu \bar{H}}{n}) s = \\ &= 2c_{i0}t_{sz} + c_{s0}s + 2c_{iv}t_{sz} \frac{\mu \bar{H}}{n} + c_{sv}s \frac{\mu \bar{H}}{n} \end{aligned} \quad [\text{HUF}],$$

from which the cost of n rounds is:

$$(13) \quad \begin{aligned} K_{sz} &= n(2c_{i0}t_{sz} + c_{s0}s) + \\ &+ 2c_{iv}t_{sz}\mu \bar{H} + c_{sv}s\mu \bar{H} \end{aligned} \quad [\text{HUF}].$$

Dividing each member of the equation by the average cycle time, the transport cost per time unit is:

$$(14) \quad \begin{aligned} K_{szt} &= \frac{K_{sz}}{\bar{H}} = (c_{i0}2t_{sz} + c_{s0}s) \frac{n}{\bar{H}} + \\ &+ (2c_{iv}t_{sz} + c_{sv}s)\mu \end{aligned} \quad [\text{HUF}/\text{time}].$$

Dividing (13) by $\mu \bar{H}$, which is the average moved quantity per cycle, we arrive at the transport cost per unit quantity:

$$(15) \quad \begin{aligned} K_{szd} &= \frac{K_{sz}}{\mu \bar{H}} = (c_{i0}2t_{sz} + c_{s0}s) \frac{n}{\mu \bar{H}} + \\ &+ 2c_{iv}t_{sz} + c_{sv}s \end{aligned} \quad [\text{HUF}/\text{unit}].$$

Results

For further investigation let us look at the total of sub costs per unit time (rental, stock-keeping, transport and loading costs).

$$(16) \quad K_{oi} = K_{bi} + K_{vi} + K_{szt}$$

Replacing the results of (6), (9) and (14) the total cost is:

$$\begin{aligned} K_{oi} &= c_b \mu H_{\max} + c_v \mu (H_{\max} + t_{sz}) + \\ &+ (2c_{i0}t_{sz} + c_{s0}s) \frac{n}{H} + (2c_{iv}t_{sz} + c_{sv}s)\mu \end{aligned}$$

For the sake of simplicity, let us assume that the length of cycles (length of time between two deliveries) and the quantity of product manufactured in one cycle are constant, that is

$$H = \bar{H} = H_{\max}, \text{ and then}$$

$$\begin{aligned} K_{oi} &= c_b \mu H + c_v \mu (H + t_{sz}) + \\ &+ (2c_{i0}t_{sz} + c_{s0}s) \frac{n}{H} + (2c_{iv}t_{sz} + c_{sv}s)\mu \end{aligned}$$

After the $H=Q/\mu$ replacement and organisation, the total cost per unit time is:

$$(17) \quad \begin{aligned} K_{oi} &= (c_v t_{sz} + 2c_{iv}t_{sz} + c_{sv}s)\mu + \\ &+ (c_b + c_v)Q + (2c_{i0}t_{sz} + c_{s0}s) \frac{\mu n}{Q} \end{aligned}$$

Figure 2 depicts the (17) total cost function and the sub costs.

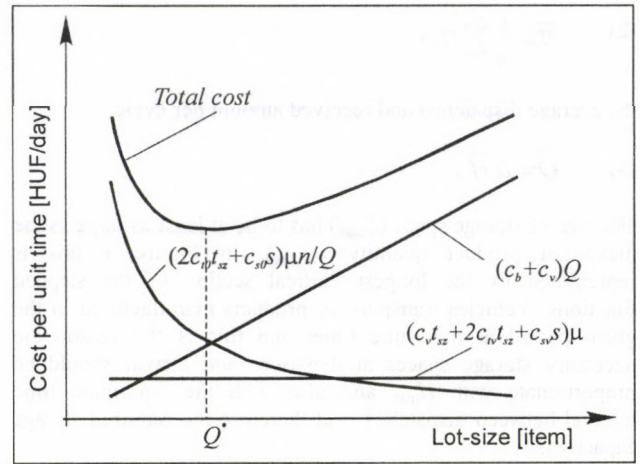

Figure 2

Changes in sub and total costs per unit time as a function of ordered quantities

Knowing the sub costs we can predict the quantity to be ordered (Q^*) (Figure 2) that minimises the total cost, that is, we look for the extreme value of the function (17):

$$\frac{dK_{oi}}{dQ} = c_b + c_v - (2c_{i0}t_{sz} + c_{s0}s) \frac{\mu n}{Q^2} = 0,$$

from which

$$(18) \quad Q^* = \sqrt{\frac{\mu n(2c_{i0}t_{sz} + c_{s0}s)}{c_b + c_v}},$$

or the optimal cycle time of ordering:

$$(19) \quad H^* = \frac{Q^*}{\mu} = \sqrt{\frac{n(2c_{i0}t_{sz} + c_{s0}s)}{\mu(c_b + c_v)}}$$

From the results of (17), (18) and (19) it is obvious that the economic lot-size and the optimal cycle time depend on the parameters of the sub costs and the proportions among them. It is also clear that zero stock could only be achieved, even in theory, if the transport cost was zero, which is impossible under normal business circumstances. Furthermore, stock level can be decreased when we can reduce the elements of transport costs in the counter of (18) and (19). However, it is not easy, as reduction of the freight sizes increases the number of transports (n) and in proportion with the number of transports it increases the length of transport and the length of time as well (the same round has to be done on more occasions), which according to (13) leads to an obvious cost increase. The question is to what extent the cost increase can be compensated by smaller vehicles' smaller constant costs.

The above calculations prove that the introduction of JIT needs a careful preparation with an accurate cost accounting.

References

- [1] CSELÉNYI, J.-BÁNYAI Á.: Planung von JIT-Zulieferer-systemen. Modelling and Optimisation of Logistic Systems, University of Miskolc, 1999. 58-70 p.
- [2] DAGANZO, C. F.: Logistics systems analysis. Springer-Verlag Berlin Heidelberg 1991.
- [3] KOTLER, P.: Marketing management. Analysis, planning, implementation, and control. Seventh edition, Prentice-Hall International Editions, 1991.
- [4] SZEGEDI Z.: A "Just In Time" szállítási-raktározási rendszertermelési és közlekedési kihatásai. Közlekedéstudományi Szemle, XXXIX évf. 10. sz. 433-437 p.

OPERATION FEATURES OF PNEUMATICALLY CONTROLLED LINEAR CYLINDER IN THE VIEW OF ENERGY SAVING

Zs. Bartus – L. Jánosi
Szent István University, Gödöllő

Introduction

Nowadays the demand is increasing for both energy-saving technologies and products. Of course it is the same in the pneumatic technology; where it is even more important because the application of pneumatic system is very expensive.

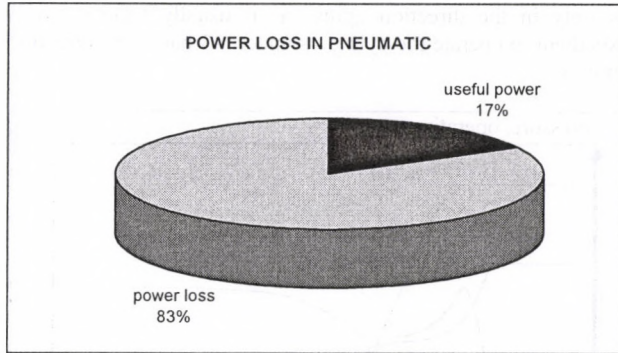

Figure 1

The efficiency of energy conversion in the field of pneumatic operation

To prove the above mentioned we have to examine the energy conversion efficiency of pneumatic actuation. According to Fig.1. the energy conversion efficiency of pneumatic actuation is 17%. To this we have to analyse the process of the energy conversion. Let's see the composition of the energy efficiency of pneumatic actuation. We can determine the P_{in} which is the performance led into the compressor by the thermodynamic law. The performance of the compressed air coming out of the compressor is P_{v1} less. The pneumatic performance of airflow keeps decreasing P_{v2} because of leaking during the flow. In the cylinder, which is the energy utilizer, P_{v3} power loss will appear. We can see this in fig. 2. clearly described.

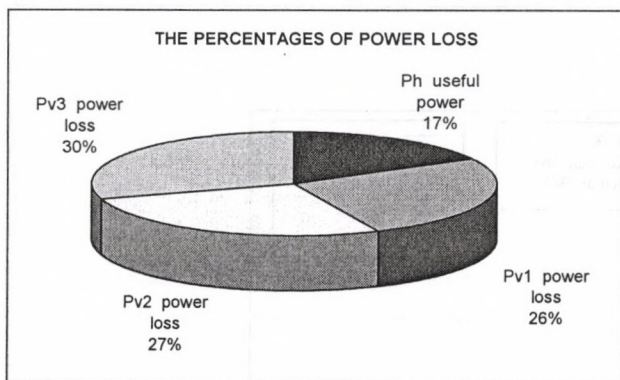

Figure 2

The percentages of power loss

Analyse the percentage of components of energy drop. The P_{v1} energy drop is the result of:

- warming due to air compression
- friction loss because of the moving elements of the compressor

Consider $P_{in} = 100\%$:

$$P_{v1} = P_{m1} + P_{s1} \quad (1)$$

$$P_{v1} = 18\% + 8\% = 26\%$$

where:

- $P_{m1} = 18\%$ because of warming
- $P_{s1} = 8\%$ friction loss because of the moving elements of the cylinder

We can see this in fig. 3. clearly described.

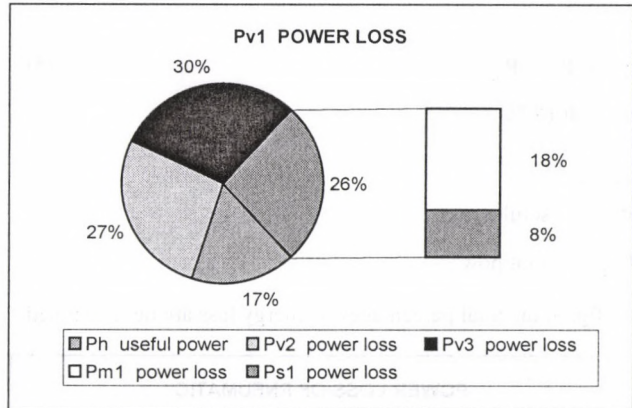

Figure 3

The percentages of energy loss of P_{v1}

The $P_{v2} = 27\%$

The P_{v3} energy loss is the result of:

- unexploitation of expansion and the back pressure
- friction loss

$$P_{v3} = P_{e3} + P_{s3} \quad (2)$$

$$P_{v3} = 27\% + 3\% = 30\%$$

where:

- $P_{e3} = 27\%$ (unexploitation of expansion and the back pressure)
- $P_{s3} = 3\%$ friction loss

In diagram:

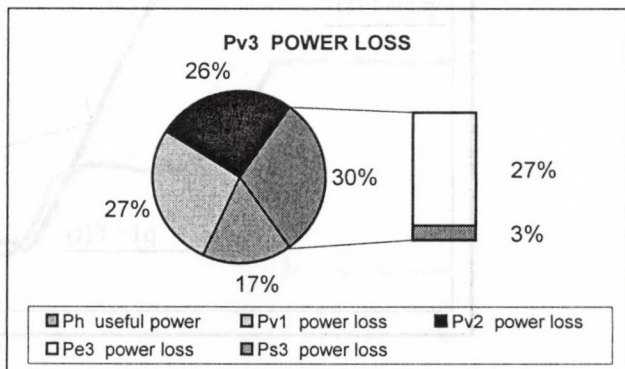

Figure 4

A P_{v3} ratio of energy loss

Total energy loss of energy conversion:

$$P_{v\bar{o}} = P_{v1} + P_{v2} + P_{v3} \quad (3)$$

$$P_{v\bar{o}} = 83 \%$$

In the view of above mentioned the efficiency of pneumatic energy conversion:

$$P_h = P_{in} - P_{v\bar{o}} \quad (4)$$

$$P_h = 0,17 \% \times P_{in}$$

from it:

$$\eta_{\bar{o}} = P_h / P_{in} \quad (5)$$

$$\eta_{\bar{o}} = 0,17 \%$$

where:

P_h = useful power

P_{in} = input power

In fig. 5. the total percentages of energy loss are demonstrated.

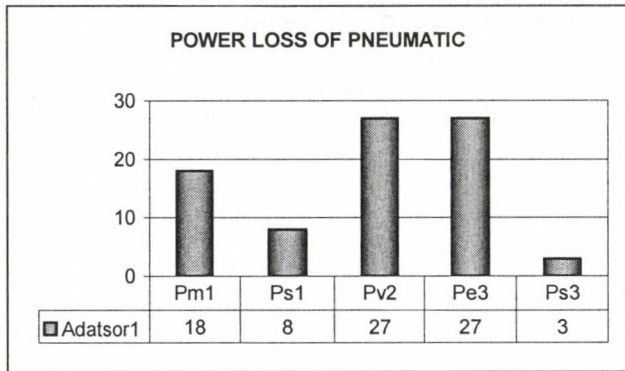

Figure 5

Comparative description of pneumatic energy loss

In the view of the above mentioned it is expedient and justified to examine the operation features of pneumatically controlled linear cylinder in the point of energy saving. Fig.6. shows us the pressure ratios in the pneumatically controlled linear cylinder on the basis of laboratory test.

Operation features of pneumatically controlled linear cylinder

Fig.6. shows us clearly the changes of pressure values in cylinder chambers. In this case the direction of piston is „plus”. It comes up in the process of the examination of the diagram that if it is justified to operate the cylinder at the pressure of 6,3 bar in the direction „minus”. If the cylinders do useful work for us only in the direction „plus” as it usually happens, it is expedient to operate the cylinders under 6,3 bar in the direction „minus”.

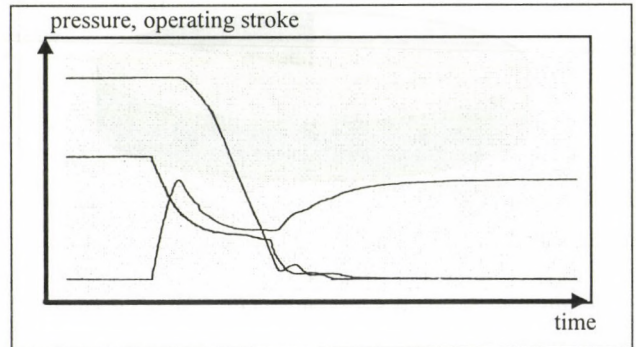

Figure 7

The result of laboratory tests of the cylinder operated with the inside-controlled valve

The role of this valve is to prevent the development of 6,3 bar. It is justified to do laboratory tests with the inside-controlled valve as well. (See fig.7.)

As we can see in fig.8. with the help of inside-controlled valve the pressure in the „minus” chamber of the cylinder will be less than 6,3 bar. In this case we can operate our cylinders in an energy-saving form because it is obvious that the used quantity of air will be less in this case.

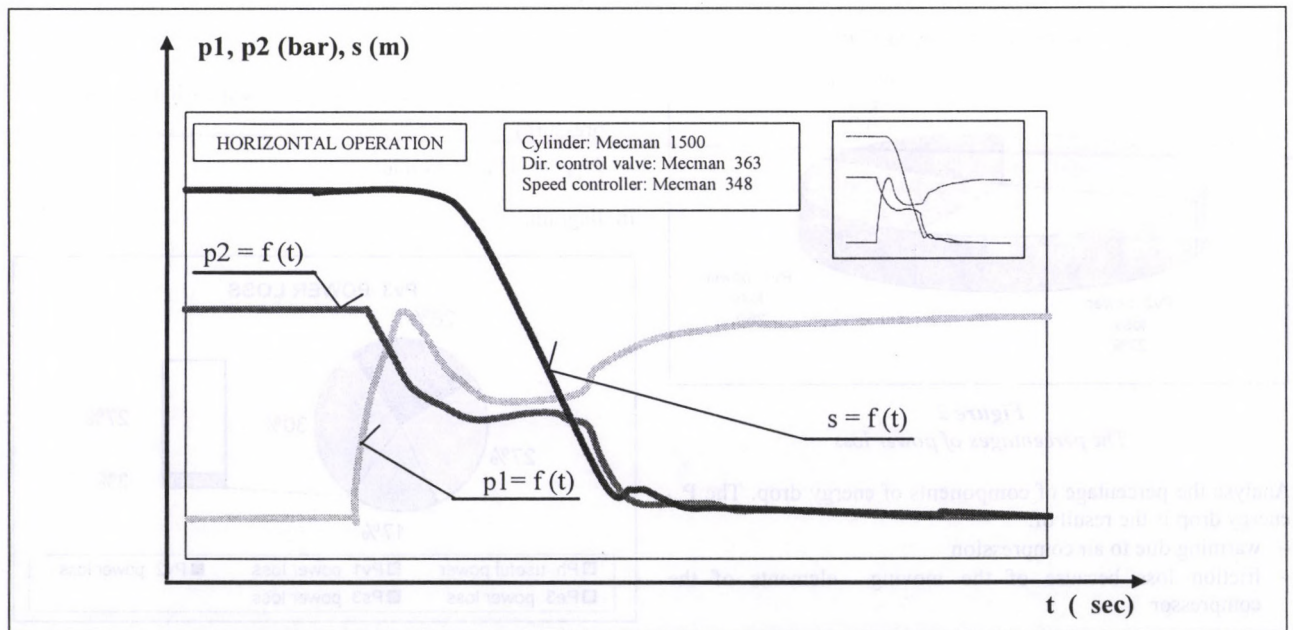

Figure 6

The pressure ratios in the pneumatically controlled linear cylinder

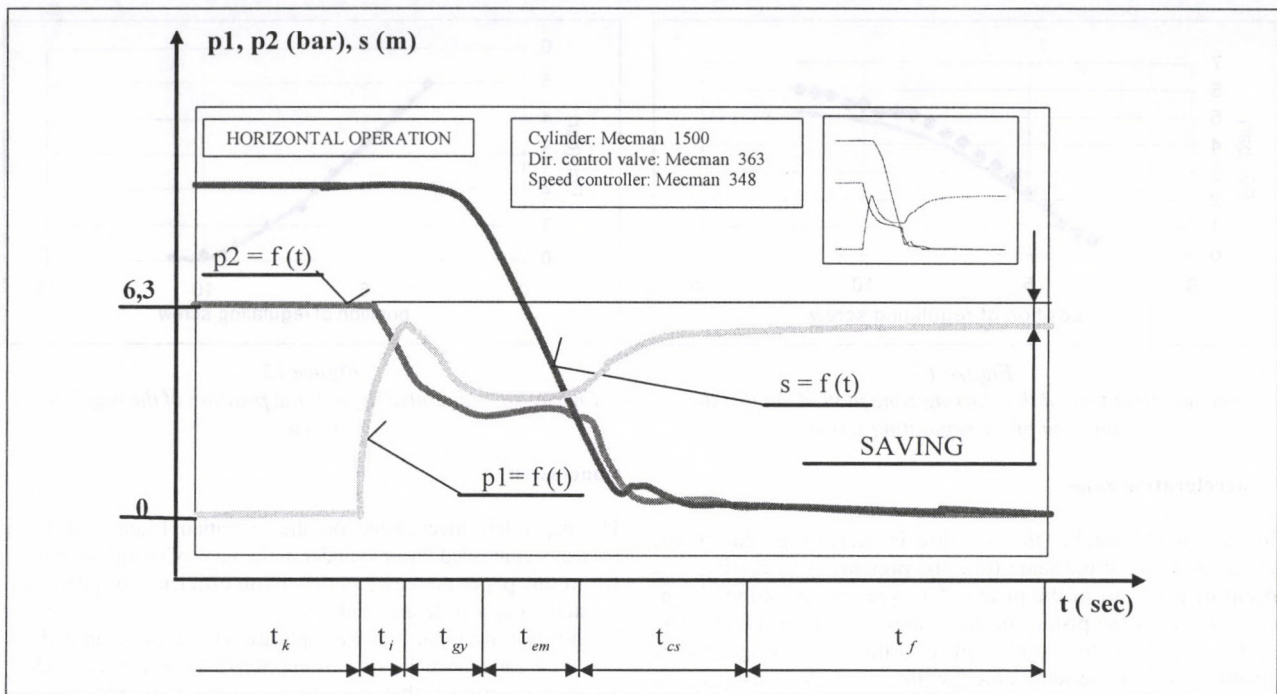

Figure 8
The zones of stroke with the inside-controlled valve

We can see in fig.8. that the cylinder cycle can be divided into phases as well.

– starting zone

The starting zone is characterized by t_i starting time.

The t_i starting time depends on:

- geometry of pneumatic cylinder
- both type and size of loading
- set of speed control valves, in fact on the desired speed

At the switching of directional control valve in the „minus“ chamber the pressure of p_2 will be generally as high as p_{2i} which is the nominal working pressure. In the chamber of "plus" the p_1 pressure is gradually decreasing, mainly because of the conductivity of restriction choke. The p_1 and p_2 pressures act on both side of the piston. When the pressure difference is sufficiently large to overcome the starting friction of the cylinder and any external load, the cylinder starts. We can state that in the starting zone in unloaded case and at the nearly the same input and output conductivity, the decrease of p_1 far less than the growth of p_2 . The reason for this is that the volume of the chambers of the cylinder is not the same. So generally the starting time is determined by the change of time in p_1 . We can see the percentages of the claim of time of each zone in fig. 9.

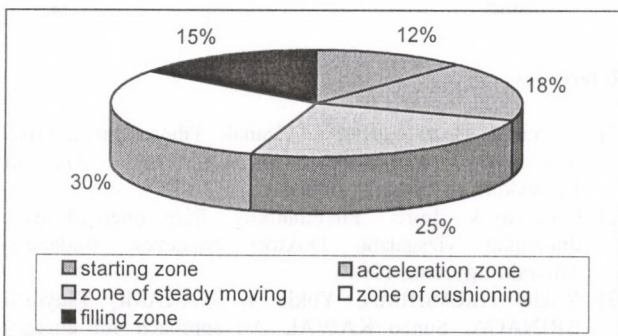

Figure 9
The percentages of the claim of time of each zone

In fig.10. we can see the length of time of starting zone plotted against the position of the regulating screw. According to fig. 10. the position of the regulating screw does not have an adverse effect on the length of time of starting zone. So the operating data will not be worse. The average length of time of starting zone: **0,38 sec.** This is **12 %** from the whole time of the moving of the piston. So we can say that the length of time is significant which passes between the beginning of air flow into the cylinder and the start of the piston. In this period the moment when the p_1 and p_2 pressures turn into equal is also significant. It happens in the second third of the starting zone. At this moment the p_2 pressure will be as big as the **80 %** of the starting pressure.

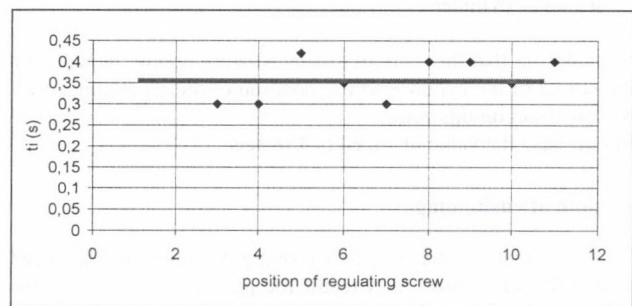

Figure 10
The length of time of the starting zone plotted against the position of the regulating screw

We must pay attention to the maximum pressure which is built up at the moment of the start of the piston at different positions of the regulating screw. We can see this function in Fig. 11. The character is linear to 7,5 revolution of the regulating screw then the character changes and the linear character returns. This characteristic curve proves that the inside-controlled valve has hindered not only the filling of the cylinder at the end of the stroke but in a very favourable way it has an energy-saving effect at the formation of the starting pressure as contrasting with the characteristic curve in Fig. 6 the six bar pressure will not be built up.

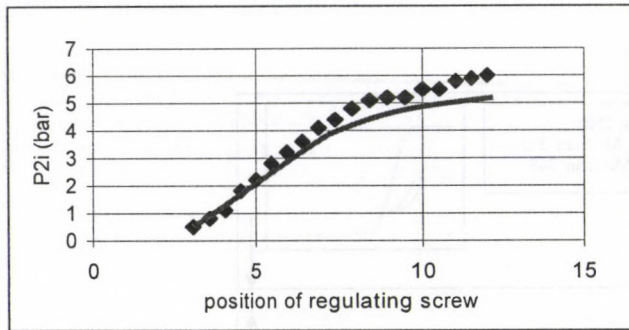

Figure 11

The length of time of the starting zone plotted against the position of the regulating screw

– **acceleration zone**

In the „plus” chamber the pressure is decreasing due to the exhaustion and at the same time the pressure is increasing as a result of the start of the piston. This pressure is defined by p_1 on this side of the piston. In the „minus” chamber the pressure is increasing due to compressed air which is flowing into the chamber and at the same time the pressure is decreasing due to the movement of the piston. This pressure is defined by p_2 on this side of the piston. So when p_1 is sufficiently low and at the same time p_2 is fairly high and the pressure difference is sufficiently large the force will be able to accelerate the piston. The longer the cylinder is the greater the acceleration is. In case of most cylinders full speed is reached after 10-30 % of the cylinder stroke. This is 18 % of the whole time of the movement of the piston.

– **zone of steady moving**

The zone of steady moving is characterized by t_{em} time.

The t_{em} time depends on:

- type of load
- bigness of load
- frictional force
- speed of piston
- stroke of cylinder

Considering that the zone of steady moving mainly depends on the stroke of the cylinder so the position of the regulating screw has no effect on this zone.

In our case the value of speed is 4 m/sec.

– **zone of cushioning**

When the piston reaches the cushioning bush the flow is forced over a throttle screw. As a result the pressure increases on the exhaust side of the cylinder and the movement is retarded.

– **zone of filling**

After the piston stops without the inside-controlled valve the „minus” chamber will be filled up to 6,3 bar as you can see in Fig. 6. but with the application of inside-controlled valve this will not happen. So with the inside-controlled valve we can realize the energy-saving operation.

So with the inside-controlled valve we can realize the energy-saving operation.

To analyse my laboratory test further I have to take the most important feature of inside-controlled valve into consideration with fig. 12. There is no doubt that the diagram can prove a very useful feature of inside-controlled valve which is the linear nature of the degree of energy-saving.

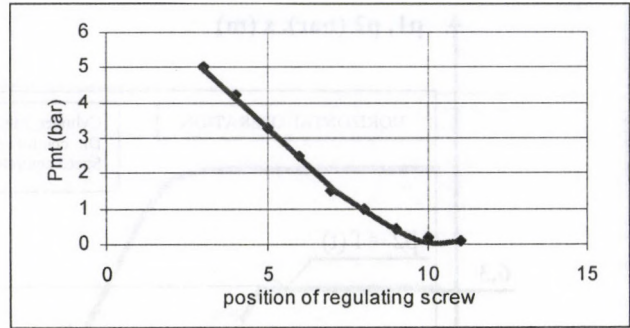

Figure 12

Energy-saving plotted against the position of the regulating screw

Conclusion

The paper has investigated on the operation features of pneumatically controlled linear cylinder in the view of energy saving

1. In this paper the energy conversion efficiency of pneumatic actuation was determined.
2. It was proved that with the application of inside-controlled valve we can reduce the air consumption of a pneumatic cylinder.
3. It was proved that due to the laboratory test we can determine the zones of cylinder cycle operated by the inside-controlled valve.
4. It is very important to discuss the energy-saving for pneumatic systems, because the energy-saving in industry is a world-wide problem related to the protection of the environment. [3]

Nomenclature

P_{in}	input power	%
P_{v1}	power loss of compressor	%
P_{v2}	power loss of air flow	%
P_{v3}	power loss of cylinder	%
P_{m1}	power loss bec. of warming	%
P_{s1}	power loss bec. of friction	%
P_{e3}	power loss bec. of unexploited of expansion and the back pressure	%
P_{s3}	power loss because of friction of cylinder	%
P_h	useful power	%
P_{v0}	total power loss	%
H_0	over-all efficiency	%
P_1	exhaust side pressure	Pa
P_2	supply side pressure	Pa
T_k	switching zone	s
T_i	starting zone	s
T_{gy}	acceleration zone	s
t_{em}	zone of steady moving	s
t_{es}	zone of cushioning	s
t_f	zone of filling	s
t	time	s

References

- [1] Csanakné Bozó Emília – Csanak Tibor: Pneumatikus berendezések üzemeltetése és karbantartása, Műszaki Könyvkiadó, Budapest, 1975
- [2] Cservényák Imre: Pneumatikus irányítóberendezések dinamikai vizsgálata, Doktori értekezés, Budapesti Műszaki Egyetem, 1994
- [3] Yukio TERASHIMA, Yukio KAWAKAMI, Tsuyoshi ARINAGA, Sunao KAWAI, An approach for energy-saving of pneumatic cylinders by meter-in circuit. FLUCOME 2000 August 13-17, 2000 Sherbrooke (QC) Canada

STUDIES ON THE DINAMICS OF TRUNK SHAKERS

E. Horváth

Szent István University, Faculty of Horticultural Science, Budapest

Calculation of vibrating masses

In an earlier study [1] the vibration of soil body around the tree trunk was measured. The measurement results have shown that the acceleration of soil body decreases exponentially as a function of radius measured horizontally from the centre of tree trunk. A new calculation method is established to calculate the reduced mass of the vibrating soil body around the tree trunk. Using a function of two variables (radius and depth) describing the acceleration distribution in the soil, the equivalent soil mass reduced to the soil surface is given by integration and the result is

$$m_{red} = \rho \frac{\pi z_0}{3 b_0^2} \quad (1)$$

where

ρ soil density, kg/ m³
 z_0 maximum depth of the vibrating soil body, m
 b_0 constant in the distribution function, 1/m

The entire mass of the tree crown (plum "Beszterce"), using measurement data, can be given by the following empirical equation

$$m_c = 1395 d^{1.48} \quad (2)$$

where

d means the diameter of the trunk above the ground level, m.

The above relationship is related to an orchard of ten years age, the trunk height is appr. 1.5 m, the trunk diameter varies between 0.13 - 0.25 m, diameter of the crown is maximum 5 m and the maximum tree height is 4 m. The equivalent vibrating tree mass consists of the trunk mass and the mass of primary limbs moving together with the trunk. These primary limbs are some 45 % of the total crown mass.

Each point of a tree is moving with different velocity, therefore, the masses must be reduced to the attachment point using the energy conservation principle.

Motion of the tree

Field observations have shown that the tree is subjected to different motions such as lateral motion, tilting motion and elastic motion due to deformation. In the tree axis under the ground level there is a virtual centre of rotation of the tree trunk, which is a function of attachment point. In this point the acceleration is zero and towards the ground level the acceleration in the soil body linearly increases, Fig. 1 shows the new tree model and the possible motion components of the vibrating tree. If the attachment point is low then the tree motion is more lateral and the elastic deformation of the trunk is negligible. On the contrary, if the attachment height increases, the tilting motion and the elastic deformation also increase. The total displacement at the attachment point consists of also three parts:

$$A = A_1 + A_2 + A_3 \quad (3)$$

where

A_1 is the displacement component of the lateral motion,
 A_2 is the component of tilting motion,
 A_3 is the elastic deformation of the trunk.

The total displacement can be calculated from acceleration measurements at the attachment point. The location of virtual centre of rotation can be constructed as shown in Fig. 2 illustrating the total displacement as a function attachment height. It can also be calculated, using Fig. 1, by the following equation:

$$z_c = h A_1 / A_2 \quad (4)$$

Fig. 3 illustrate the soil mass (3), the soil plus canopy mass (2) and the total mass as a function of attachment height concerning a plum tree of 180 mm trunk diameter. It is to be seen that the main mass component is the soil mass especially at low attachment heights.

Internal forces are given by multiplication of displacement and spring constant. The total spring constant consists of three components connected in series

$$1/k = 1/k_1 + 1/k_2 + 1/k_3, \quad (5)$$

where

k_1 is the spring constant of the lateral motion,
 k_2 is the spring constant of the tilting motion,
 k_3 is the elastic spring constant of the tree trunk.

Using beam deflection theory, the elastic spring constant can easily calculated. The spring constants k_1 and k_2 , and the displacement components A_1 and A_2 , can be determined using experimental results.

Determination of spring constants

The spring constant k_1 is characteristic for the vibrating soil body suffering horizontal periodic displacements. Pure parallel motion of the tree trunk occurs probably at zero attachment height. Actual measurement can not be carried out at zero attachment height, but the results obtained at low attachment height can be extrapolated to the ground level. The equilibrium of forces in horizontal direction at the ground level is

$$F_g = k_1 A_1 - m_r A_1 \omega^2,$$

and further

$$k_1 = \frac{F_g + m_r A_1 \omega^2}{A_1} \quad (6)$$

where

F_g is the excitation force,
 m_r is the total reduced mass at $h = 0$,
 ω is the exciting frequency.

The elastic spring constant of the tree trunk will be calculated using beam deflection theory:

$$k_3 = \frac{3d^4 \pi E}{64h^3} \quad (7)$$

where

d is the diameter of the trunk without bark,
 E is the modulus of elasticity,
 h is the attachment height.

Using high attachment height ($h = 1.1$ m), the parallel motion of the trunk is small and using the obtained value of k_1 , Eq.(5) can be solved for k_2 . Naturally, the knowledge of the total spring constant k is also needed. This can be obtained from acceleration measurements, from which the total displacement is known. Similarly to Eq.(6), the total spring constant is given by

$$k = \frac{F_g + m_r A \omega^2}{A} \quad (8)$$

The spring constant k_2 is a function of attachment height. The external force F_g with the arm h is counterbalanced by a reaction moment M_o (Fig. 4), therefore, we may write

$$F_g (h + t) = M_o \alpha \quad (9)$$

The displacement of the tilting motion at the attachment point is

$$A_2 = (h + t) \alpha \quad (10)$$

where

α is the angle of tilting,
 t is the hypothetical location of reaction moment under the ground level (generally taken as $t = 0.1$ m).

Using the above equations, the spring constant k_2 can be expressed as follows

$$k_2 = \frac{F_g}{A_2} = \frac{M_o}{(h + t)^2} \quad (11)$$

The reaction moment M_o for a given fruit tree is constant and, using its value, the spring constant k_2 can be calculated as a function of attachment height.

Fig. 5 shows the variation of spring constants as a function of attachment height. It can be concluded that the spring constants k_2 and k_3 considerably decreases, as the attachment height increases.

The displacement components of the motion

Knowing the spring constants, the displacement components can be calculated for arbitrary attachment height:

$$A_1 = \frac{F_g + m_r A \omega^2}{k_1} \quad (12)$$

$$A_2 = \frac{F_g + m_r A \omega^2}{k_2} \quad (13)$$

$$A_3 = \frac{F_g + m_r A \omega^2}{k_3} \quad (14)$$

Using the above equations, the calculated sum of displacements agree well with the measured total displacements as a function of attachment height. The results are depicted in Fig.6. It can be seen that for increasing attachment heights the displacement component A_1 decreases but A_2 and A_3 increase.

Equilibrium of horizontal forces

The equilibrium equation of horizontal forces for the different inertia-type tree shakers is slightly different. The slider-crank mechanism is governing by the following equation

$$m_g (r - A) \omega^2 = F_g = kA - m_r A \omega^2 \quad (15)$$

The shaker mechanism with two unbalanced masses rotating in a housing with considerable own mass (m_h) has the following equation

$$m_g r \omega^2 = kA - (m_r + m_h) A \omega^2 \quad (16)$$

where

m_g is the unbalanced mass,
 r is the crank radius,
 m_r is the reduced mass of the tree.

In Eq. (15) the actual displacement is $(r - A)$ because the unbalanced mass is moving opposite to the displacement of the tree.

Shaker mechanism with two unbalanced masses has a considerable housing mass attached to the tree trunk. Therefore, we should consider the sum of attached masses ($m_r + m_h$). The mass of housing is directly coupled to the attachment point, therefore, it needs no reduction.

Owing to the large additional mass, the shakers with two rotating masses are less sensitive to the variations in tree size and attachment height. This is also shown in Fig.6 illustrating other shaker mechanisms too.

Conclusions

Experimental measurements carried out in plum orchards have shown that the root and a given soil mass is also part of the vibrating system. A new calculation method is given to determine the equivalent soil mass. A new tree model is established allowing different motions such as lateral, tilting and elastic deformation. The combined motion has a virtual centre of rotation lying under the ground level depending on the attachment height. The single motion components are dependent on their own spring constant. Based on experimental results, a calculation method is established to determine the spring constants for a given case. The results contribute to the better understanding of shaker dynamics and a more efficient use of shakers will be possible concerning energy requirement and fruit removal.

References

- [1] Horvath, E. (2000): Dynamics and energy relations of trunk shakers. Doctor Thesis, Hungarian Academy of Sciences, Budapest, Hungary, pp 1-135.

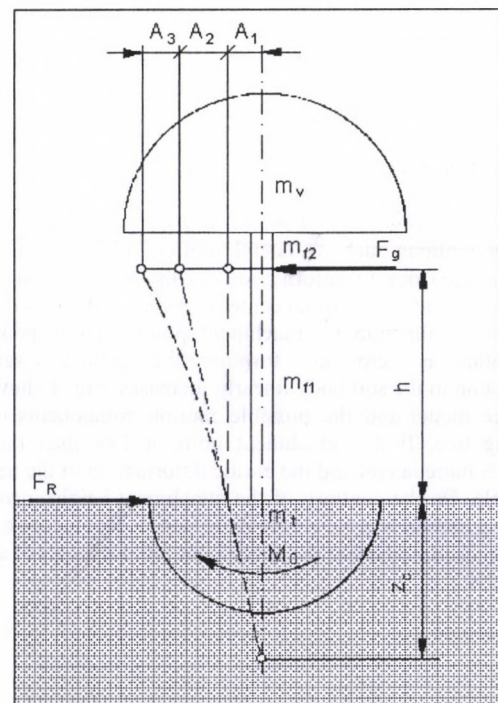

Figure 1
 Tree model showing different possible trunk motions

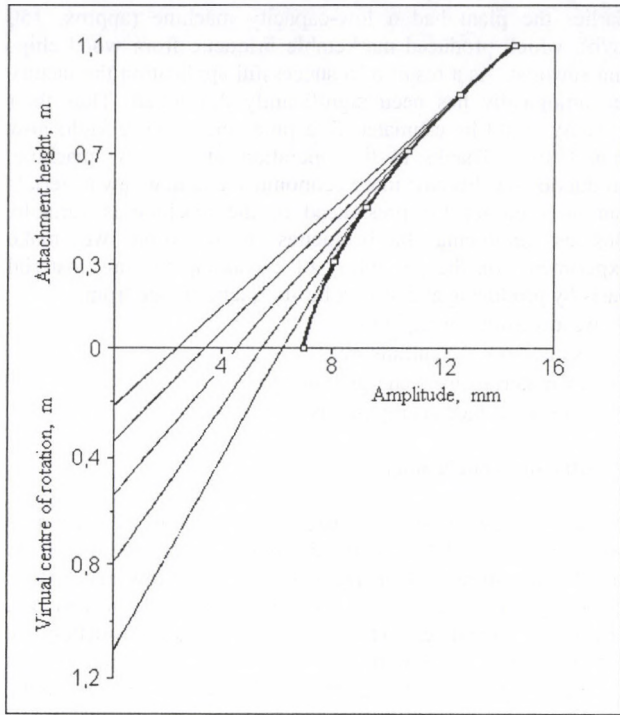

Figure 2

Location of centre of rotation as a function of attachment height

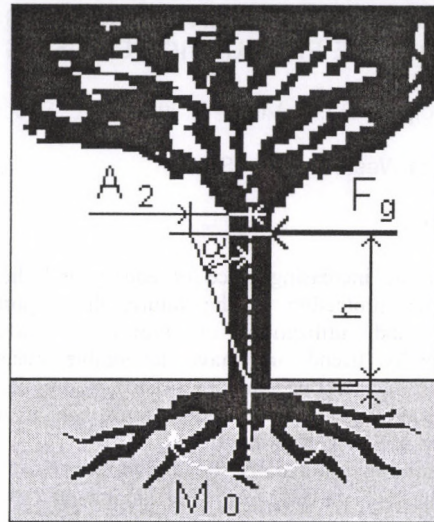

Figure 4

Equilibrium of external and internal moments on a tree

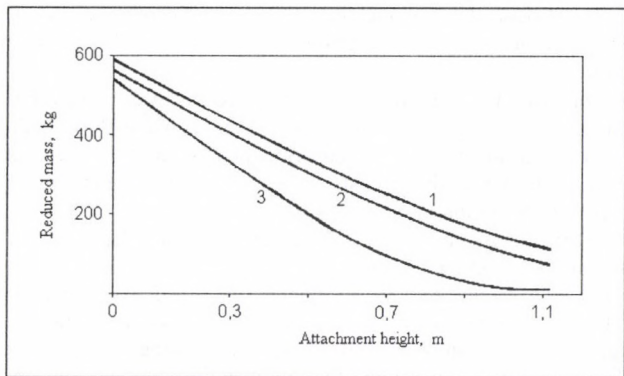

Figure 3

Total reduced mass and its components as a function of attachment height

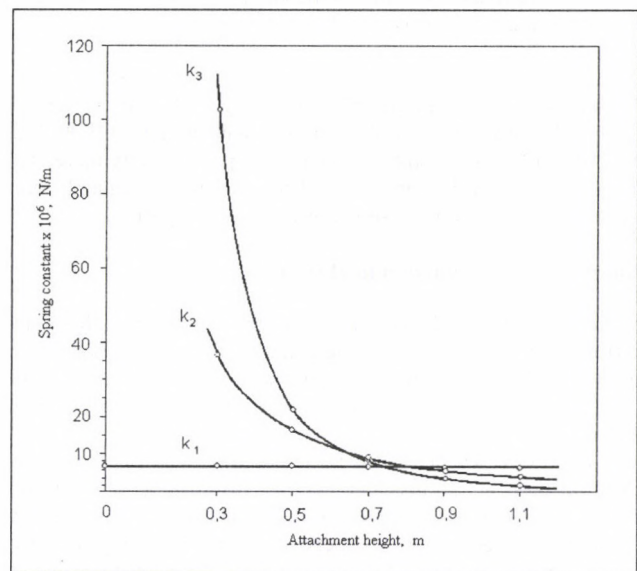

Figure 5

Variation of spring constants as a function attachment height

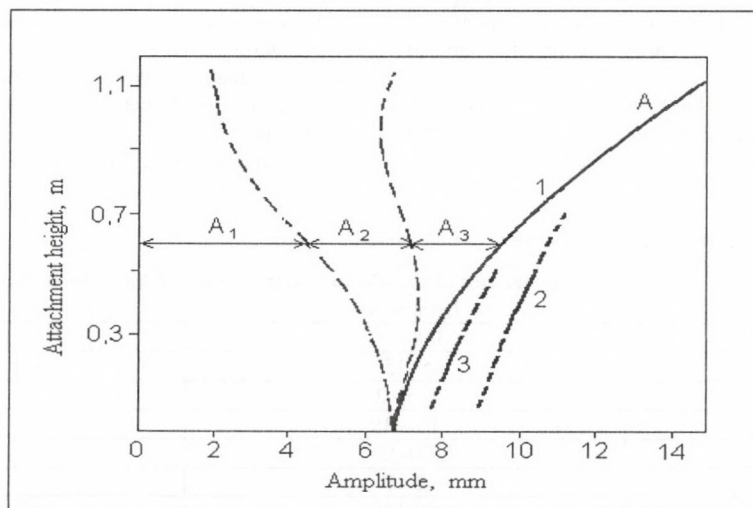

Figure 6

Displacement and its components as a function attachment height
 1 slider-crank mechanism, 2 shaker with two rotating masses, 3 shaker with multidirectional shake

INCREASING THE RAW MATERIAL BASIS OF BIO-BRIQUETTE PRODUCTION BY USING NEW MATERIALS

B. Marosvölgyi – D.I. A. Vityi – R. Ivelics – L. Szűcs Szabó
University of West Hungary, Sopron

Preliminary

Because of the increasing price of energy and the role of environmental protection in the future, the importance of production and utilization of biofuels - which are environmentally friend and have favourable material and energetic attributes at the same time - keeps getting larger. One of these energy sources is biobriquette, which made by compression of lignocelluloses.

Concerning the environmentally-friendly biobriquettes:

- the product is made only from pure and natural lignocellulose,
- no surplus foreign materials are used during the processing period
- the final product is thanks to the large compression, the high temperature and partly the effect of polymerization of hemicelluloses.

Thanks to its environmental advantages, EU is going to double the share of renewables in the member states (1999: 7,2 %; 2015: 12,5 %). In some Western European country there is a great interest in bio-briquette. The increasing demands are satisfied partly by Central-Eastern-European import.

Bio-briquette production in Harka

Although domestic demand has already appeared and there are serious export possibilities there are just few operating bio-briquette plants in Hungary. However the increasing demands cannot be satisfied now because of the lack of basic material and productive capacity.

The productive capacity can be increased at will, but the basic material basis – sawdust and shavings from the conversion of timber – is limited. Expansion of the basis is not to be expected as the raw materials (by-products) are more frequently used by the wood-working firms for energy purposes. Thus experiments on the possibility of expanding the lignocellulose raw material basis are needed.

With the help of the Hungarian Ministry of Education and in cooperation with the University of West Hungary a bio-briquette plant has been established in Harka owned by Bio-Brikett Ltd, partly for experimental purpose, partly for profit-orientated industrial unit.

This plant produces export-quality bio-briquette in accordance with EU standards (with 1-1,2 kg/dm³ density, cylindrical, 75 mm diameter, 200 mm length, more information are in Table 1.).

Earlier the plant had a low-capacity machine (approx. 150 kg/h), which produced marketable briquette from wood chips and sawdust. As a result of a successful application the factory technologically has been significantly developed. Thus their capacity could be estimated five times bigger (800 kg/h) now than before. Thanks to the operation of the new machine, production has become more economical and new raw materials can be used for the press-head of the machine is variable. Besides producing bio-briquettes from wood we make experiments on the possibility of expanding the raw material basis by producing and testing bio-briquettes made from:

- wastes from sawing industry
- wastes from the cutting areas
- raw materials from energy plantations
- and soft-stalked energy plants.

Results and conclusions

- In the case of wood wastes from sawing industry it is obviously unavoidable to dry the raw material because of its variable moisture content. Dehydration of the raw materials is an energy-intensive process, and can be profitable only in case of relatively great scale ($I_{\min} = 1,5$ t/h). Thus a briquette-plant with this kind of technology and less than 2000 t final product per year is probably not profitable between recent economic conditions.

Utilization of lumpy wood waste was a special problem. This kind of raw material has to be cut by a special chopping-machine before briquetting. During chopping and briquetting of bark, the machines have been significantly amortized. The specific power consumption was also high, 200 kWh/t or more.

- In case of wastes from the cutting areas it was proved that bio-briquette production is not economical, as wood chips made from this kind of raw material are expensive and polluted, as well as the unavoidable costs of gathering and drying and of bigger amortization of machines are high.

- Dendromass from energy plantations has the smallest amount of pollution material and may be economically viable to process it, for the harvesting machine chopped wood directly into chips. In this case a special pressing machine should be applied (which can produce bio-briquette by using greater chips than commonly as well) and the raw material must be stored in a dry place for a long time so that its moisture content reduces below 20%, in natural conditions. To process raw material with the original volume of moisture content (having at the moment of harvesting) a specific pressing machine is needed. In this case the power input can be more than 400 kWh/t. Briquetting of raw materials from energy plantation can be profitable if this kind of plantations would become common and energy plantation and biobriquette factory would operate within the same enterprise.

- Bio-briquette from energy plants is a new field of research.

Table 1 Attributes of the briquettes made of wood and the one made in Harka

Characteristics	Characteristics of the bio-briquette made from wood	Characteristics of the bio- briquette in Harka
Density (g/cm ³)	0,8 -1,4	0,9 - 1,2
Water content (%)	5 -15,	7
Ash content (%)	0,5 - 2	1,5-3
Fuel value (MJ/kg.)	17 – 19	18-19
Power density (MJ/dm ³)	20-25	20-25
Abrasion factor (%)	2 - 7	2
Power requirement (kWh/t)	90-120	96
Storable for 1-2 months in dry place, for 4 weeks in humid conditions.		
Energy content of 1 kg briquette from wood equals with 0,5 kg oil.		
SO ₂ emission is negligible.		

Table 2

Raw material	Density (kg/cm ³)	Bulk density of the raw materials (kg/cm ³)	Water content (%)	Abrasion factor (%)	Ash content (%)	Fuel value (MJ/kg)
Poplar	1,06-1,11	0,182-0,188	10-12	<1	2,0-2,3	17,8
Chinese reed	1,06-1,30	0,152-0,154	6-10	0,4-1,9	2,8-3,8	16,8
Energy hemp	<1	0,110-0,136	10-12	40	6,7-7,0	16,1
Energy grass	1,28-1,31	0,180-0,190	6-8	0,1-1	4,0-4,3	16,6

There are two main subjects of these investigations:

- process of highly productive (15-20 t/ha/year) soft stalked energy plants (miscanthus, hemp, reed-grass).
- production of bio-briquette from the mix of the pure chips of these energy plants and of sawdust in order to expand the raw material basis.

Using the mixed material we got bio-briquettes with the required level of stability, density but relatively high ash content. The combustive characteristics were also proper, although the velocity of gasification – which is the precondition of ignition – is lower.

Briquettes made from energy plants alone had a reduced stability, restrained ignition and the ash content was much more than of the wood (table 2.). By burning this kind of bio-briquette some volatile oil appeared, odoured special smell. Analysis of more detailed heating characteristics of these briquettes have to be done in the future.

In the case of proper heating features, the raw material basis of the bio-briquette production can be enlarged.

Nowadays there is a market demand for quality bio-briquette made from other agricultural or industrial waste plants. Yet, the expansion of the market and the possibility of direct sale will hike the demand of raw material basis of bio-briquette after the EU enlargement.

QFD METHOD ADOPTION TO SELECT SOIL TILLAGE SYSTEMS

M. Birkás¹ – L. Csík²

¹Szent István University, Gödöllő

²MEZŐGÉP Ltd.

Aim of the research

The requirements in soil tillage have any differences under eras and fulfilment of the demands depends on the arable site, tools and expertness. From the tillage tools and systems are considered in the tillage season, the most suitable variant is to be selected to fulfil the requirements entirely.

Material and method

The QFD method can be adopted to select the most suitable soil tillage system. The QFD, as the Quality Function Deployment in the quality activity to determine the production and/or service development tendencies numerically according to customer demands [1]. This graphical method is cited in the literature with a matrix form or with the "House of Quality". In this paper the basic matrix form is applied. Requirements are listed on the left side of the scheme weighting between 1-10 points corresponding of their importance, while on the right side the possible methods or tools are indicated:

WHAT (aims, requirements)	Weighting of the requirements (1-10)	HOW (methods, tools for realization)
		possible variants

Values of the matrix are assumed between 0-3 depending on the conformity of the methods. Interpretation of the correlation: 0=zero; 1=weak; 2=medium; 3=strong conformity. The most suitable method can be selected according to the product value which is obtained if the weight number was multiplied with the correlation index. We suggest the QFD method adoption to soil tillage practice. In this paper tillage systems are selected by the simplified, two-stepped QFD analysis according to fulfilling of the requirements. In the 1st step 7 tillage systems are examined with four principal factors – yield assurance, cost saving, environment conservation and surface aesthetics – and systems are ranked by their conformity. The alternatives of the most conform system are to evaluate in the 2nd phase with supplementary factors to raise the most suitable variant. The 3rd step may be selection of the tillage tools.

Results

Adaptability of the QFD method is presented through 2 examples [2,3]. The first analysis concerns the tillage goals can be fulfilled at the present situation [Table 1, 2], while the second probe sounds to accomplish the future requirements [Table 3, 4].

Tillage requirements at present situation

Most important demands of soil tillage are to maintain the yield assurance (or optimal yield level) and to save the costs. In a conventional view the surface aesthetics (clean surface, no residues) is more acceptable than the environment conservation. Therefore the weighting of tillage requirements followed these stand-points. Ranks of the tillage systems were: improved ploughing >mid-deep loosening>disking>conventional ploughing>heavy-duty cultivator use>till-plant>direct drilling. The improved ploughing system (use reversible plough combined with surface preparation element and then seed-bed preparation and plant) is ranked the 1st, since the tillage requirements are fully realized by this way. The mid-deep loosening is ranked to 2nd and it fulfils the demands very well. The improvement of soil condition in the root zone is necessary, but the practice handles this question secondarily. The disking system (3rd) is used commonly, though the regular applying shows risk. Farmers prefer the conventional ploughing (use on land plough and 2-3 secondary traffics) to other systems in spite of the risk which is performs in the ranking (4th) too. New systems, such as cultivator use, till-plant and direct drilling are undervalued by the conventional farmers [Table 1]. The next step is to analyse the improved ploughing system [Table 2]. The question, which tillage processes can be used to fulfil the requirements with the less risk. Four examples, originated from the practice were evaluated:

- 1: stubble stripping with disk – ploughing (reversible tool) and surface preparation – seedbed preparation – plant – press (5 passes).
- 2: stubble stripping with cultivator – ploughing (reversible tool) – clod breaking – seedbed preparation – plant and press (5 passes).
- 3: stubble stripping with cultivator – ploughing (reversible tool) and surface preparation – seedbed preparation and plant (3 passes).
- 4: stubble stripping with cultivator – ploughing (reversible plough with subsoiler shank) and clod breaking – seedbed preparation and plant (3 passes).

Table 1 Performing of the soil tillage requirements at present

Correlation: 0 no; 1 weak; 2 medium; 3 strong

Principal requirements of soil tillage	Weighting of requirements (1-10)	Soil tillage variants						
		Conventional ploughing	Improved ploughing	Disking	Mid-deep loosening use	Heavy-duty cultivator use	Till-plant	Direct drilling
Yield assurance	10	3	3	2	3	2	1	1
Cost saving	8	1	2	3	2	2	2	2
Surface-aesthetics	6	3	3	2	2	1	2	0
Environment conservation	4	0	2	2	2	3	2	1
Total points		56	72	64	66	54	46	30
Rank		4.	1.	3.	2.	5.	6.	7.
%		14.4	18.6	16.5	17.0	13.9	11.9	7.7
Acceptable [$\geq 15\%$]			x	x	x			
Next examination			↓					

Table 2 Alternatives in an improved ploughing system

Correlation: 0 no; 1 weak; 2 medium; 3 strong

Evaluation standpoints (tillage requirements)	Weighting of requirements (1-10)	Tillage variants			
		1.	2.	3.	4.
Optimal yield level	10	1	2	2	3
Well-managed operations	9	3	1	1	1
Less residue on the surface	8	3	3	3	3
Less moisture loss	6	0	2	3	2
Less tillage faults	5	0	2	3	3
Total points		61	75	86	90
Rank		4.	3.	2.	1.
%		19.6	24.0	27.6	28.8
Acceptable [$\geq 25\%$]				x	x
Examination can be continued					↓

In the evaluation procedure two main factors were indicated, namely the level of the yield and the harmony between operations. Other requirements concern minimal stubble residues on the soil surface and cause less tillage faults and soil moisture loss. Weighting of the factors were followed the way of thinking at the present situation. From the four variants are reasonable two (3rd and 4th), if the yields were reached with minimal moisture loss and with the least risk. Seedbed preparation and plant are used in the same pass in both two variants. The best is the 4th variant by the use of the reversible plough combined with subsoiler shank to alleviate soil compaction status in the root zone. Other systems (1st, 2nd) fulfil the tillage requirements with more passes, when the risk is fairly greater and those are not reasonable at the present economical circumstances.

Tillage requirements in the future

In near future environment conservation that will be the principal requirement of soil tillage. Hereby, the yield assurance can be reached and maintained on soils tilled with less harms and costs. The soil surface aesthetics will be considered by the level of conservation. QFD analysis follows the same tillage systems like in Table 1. However, the principal requirements are modified according to the new challenges [Table 3]. The rank reflects the level of the soil, moisture and energy conservation: heavy-duty cultivator use>mid-deep loosening>

till-plant>direct drilling>improved ploughing>disking> conventional ploughing. Expectations in soil and environment conservation can be fulfilled entirely by the use of cultivator system. Mid-deep loosening is ranked the 2nd, since it decreases tillage induced subsoil compaction and improves the yield assurance. Soil conservation requirements are fulfilled by means of the till-plant and direct drilling systems with great probability. The improved ploughing system (5th) can be used with less risk generally, comparing to the disking system (6th). Conventional ploughing has minimum value in the rank, because it is unsuitable for soil conservation.

The next phase is to select the best variant from the heavy-duty cultivator systems on the basis of the new qualification requirements, that is: less tillage faults and costs, minimal water loss and mulching and after all less production risk [Table 4]. The possible tillage processes are as follows:

- 1: stubble stripping with disk – weed control with disk – primary tillage with cultivator – surface preparation – plant and press (5 passes).
- 2: stubble stripping with disk – weed control with cultivator – primary tillage with cultivator – seedbed preparation and plant (4 passes).
- 3: stubble stripping with cultivator – weed control with cultivator – primary tillage with cultivator – seedbed preparation and plant (4 passes).
- 4: stubble stripping with cultivator – primary tillage with cultivator – seedbed preparation and plant (3 passes).

Table 3 Performing of the soil tillage requirements in the future

Correlation: 0 no; 1 weak; 2 medium; 3 strong

Principal requirements of soil tillage	Weighting of requirements (1-10)	Soil tillage variants						
		Conventional ploughing	Improved ploughing	Disking	Mid-deep loosening use	Heavy-duty cultivator use	Till-plant	Direct drilling
Environment conservation	10	0	2	1	3	3	3	3
Optimal yield level	8	1	2	2	3	2	2	2
Cost saving	8	0	2	2	2	3	3	3
Surface aesthetics	4	1	3	2	2	3	1	0
Total points		12	64	50	78	82	74	70
Rank		7	5	6	2	1	3	4
%		2.8	14.9	11.6	18.1	19.1	17.2	16.3
Acceptable [$\geq 15\%$]			x		x	x	x	x
Next examination						↓		

Table 4 Alternatives in a heavy-duty cultivator using system

Correlation: 0 no; 1 weak; 2 medium; 3 strong

Evaluation standpoints (tillage requirements)	Weighting of requirements (1-10)	Tillage variants			
		1.	2.	3.	4.
Less tillage faults	10	1	1	2	3
Less tillage costs	10	0	2	2	3
Less moisture loss	9	1	2	2	3
Less production risk	9	1	2	3	2
Mulching on the surface	8	2	2	3	3
Total points		44	82	109	129
Rank		4.	3.	2.	1.
%		12.1	22.5	30.0	35.4
Acceptable [$\geq 25\%$]				x	x
Examination can be continued					↓

Some of the variants give agronomical and environmental advantages including less tillage faults and moisture loss with less production risks by means of the less traffic (3rd, 4th). Seedbed preparation and plant in the same traffic results not only minimal compaction harm but less costs, as well. The disking may apply on stubbles covering with weeds, however, soil structure deteriorates (dust formation) during the procedure. In the environmental viewpoint less tillage procedure results less tillage harms, although the less is never the same under different soil condition. This study is the first step to adopt the QFD method in soil tillage relation [Table 5].

Evaluation of the results and conclusions

A simplified, two-phased QFD method was adapted to rank soil tillage systems. In the 1st phase 7 systems were selected, while in the 2nd, 4 variants came to examine. The fulfilment of the tillage requirements were evaluated in two periods, as the first concerns to the present situation, while the second sounds to the future one. The most important conclusions concerning to the present tillage situation, are as follows:

1. In the 1st phase the fulfilment of 4 main tillage requirements were examined: yield assurance, cost saving, environment conservation and surface aesthetics. These factors and their weighting reflect that conventional thinking which quite influences the tillage practice now. Although the improved ploughing system has not wide-spread yet, it ranked the 1st, since the tillage requirements are fully realized.
2. The alternatives of the most conform system was evaluate in the 2nd step with 5 supplementary factors, that is optimal yield level, manageable operations, less residue on the surface, less moisture loss and minimal tillage harm. Most advantages were realized by the use of reversible plough combined with subsoiler shank and when the seedbed preparation and plant

operated in the same traffic.

Essential points connected with realization of tillage demands in the future:

1. In the 1st phase, in harmony of soil conservation, four requirements were evaluated how are realized by 7 different tillage systems. The high environmental sound expectation was realized by the cultivating system.
2. In the 2nd step to select the best variant was carried out by the fulfilment level of new qualification requirements, that is: less tillage faults and costs, minimal water loss and mulching and after all less production risk. In this reason the soil structure and moisture conservation by minimal traffic gave the greatest advantage.

Others:

1. It helps to farming practice to select the most suitable tillage system in any arable site and economical circumstances.
2. Results of the QFD analysis can be adapted at producing firms. They are informed on the new tillage trends, which give instructions to the machine development. In the 3rd phase the type of the tillage tool may also be indicated. This analytical work can also be used by the trading firms in accommodation to the market demands.

References

[1] Qualitätsmanagement. WEKA Fachverlag für technische Führungskräfte GmbH, Augsburg
 [2] Birkás M., Csík L. 2003. A talajművelési rendszerek kiválasztása QFD módszer adaptálásával. MTA AMB 27. Kutatási és Fejlesztési Tanácskozás, Gödöllő, 2003 január 21-22. Kiadvány (szerk. Tóth L., Vinczeffly Zs-né), 2. kötet, pp. 11-16.
 [3] Birkás M., Csík L. 2003. A körülményekhez legalkalmasabb művelési rendszer kiválasztása QFD módszer segítségével. Mezőgazdasági Technika, 44. 1. 40-42.

Table 5 Possible phases in QFD analysis

Possible phases in QFD analysis	Specialists
1. on the basis of conformity to main tillage requirements to select the most suitable from the possible tillage systems	Soil tillage researchers and farmers
↓	
2. to select the best variant of possible processes by fulfilling of supplementary (e.g. environmental) requirements	
↓	Designers, producers and merchants
3. to select the most suitable tillage tool to the given soil condition from the possible ones	
↓	
4. to determine the tillage tool construction trend (if not available)	Designers, producers and merchants
↓	
5. to select the machine unite construction trend	
↓	
6. to select the best production process	

A NEW CHALLENGE IN ENVIRONMENTAL POLLUTION: ELECTROSMOG

P. Szendro⁽¹⁾ – A. Szasz⁽²⁾

¹ Szent Istvan University, Gödöllő

² Strathclyde University, Glasgow, Great-Britain

This research has been supported by OTKA (Hungarian Scientific Research Found) T- 043385 and by "Modelling of Processed Plant Structures" research group of Hungarian Academy of Sciences.

Introduction

Electrosmog is the convergence of non-ionizing electromagnetic radiation, which, from the lowest frequencies (and electrostatic fields) to the highest, (up to the ionizing threshold) surrounds us and, coming either from natural or artificial sources, bathes us in a stream of radiation, which we not only live with, but have become accustomed to. At the top of the spectrum is just under the domain of ultra-violet light, while the bottom could be even the static field. Electrosmog is too weak to produce any sort of ions or ionizing effect within the living organisms, their effects being manifested in other ways. Electrosmog falls within the non-ionizing domain yet, with its disruptive effects on the body's functions, it poses a new challenge in the on-going history of environmental pollution [1], [2]. While this sort of environmental pollution is imperceptible to biological systems, those interactions are still capable of disrupting those systems' internal orders and coherent, metabolic processes [3], [4].

The effects of electrosmog can be, in essence, divided into two fundamentally different categories: passive electrosmog effects (acting on the nutrition which could be incorporated by other living objects like humans and/or animals) and active electrosmog effects (effective directly to the actual living object e.g. human body). The theoretical foundations of the field were centering on the noise effects on the biological objects, [5], [6], [7].

Heat effects of the electromagnetic field

A fundamental effect is the heating by the energy absorption from the electrosmog radiation. The main energy delivery is measured by the SAR (Specific Absorption Rate) value in every case. The absorbed energy-density (ρ_w) of the electromagnetic radiation is [8]:

$$\rho_w = \frac{1}{2} \epsilon_0 \epsilon_r E^2 + \frac{1}{2} \mu_0 \mu_r H^2$$

where

$\epsilon_0 = [(36\pi)^{-1} \cdot 10^{-9}]$ and $\mu_0 = [(4\pi) \cdot 10^{-7}]$ are the absolute, ϵ_r and μ_r are the relative magnetic permeability and relative permittivity of the given media, respectively.

Microscopically, the simplest model of a multi-cellular system (e.g. living tissue) may be described as a set of various electrolytes encapsulated in highly polarized thin films (various membranes), and the whole system is arranged in a special aqueous electrolyte (extracellular matrix, ECM), a media for the social signals and metabolic material-exchange. The cell-membrane thickness ranges between $4 \div 10$ nm, and its potential ranges roughly between $70 \div 90$ mV. The membrane capacity is enormously large: 10^6 F/m². This structure forms in relatively low frequencies a good barrier for the electric field penetration into the cell. The capacitive forced electric field generation provides dominantly the direct heating up of the ECM [9]. In this case the cytoplasm is heated by a heat-flow through the cell membrane. The actual energy balance on the membrane is:

$$\rho_i c_i V \frac{dT}{dt} = I_q + P_m,$$

where $\rho_i c_i$ is the specific heat capacity of the cell, V is the cell-volume, P_m is the metabolic heat-power. The I_q heat-current contains a metabolic and an electric term:

$$I_q = I_{qm} + I_{qc},$$

where $I_{qm} = -P_m \approx \text{const.}$, so $I_{qc} = \rho_i c_i V \frac{dT}{dt}$.

Hence the heat-current density is

$$j_{qc} = \rho_i c_i \frac{V}{A} \frac{dT}{dt},$$

where A is the surface area of the cell. Its numerical value at 1K/s heating rate equals $j_{qc} \approx 140 \frac{W}{m^2}$, which is significant. The temperature difference between the two sides of cell-membrane can be calculated by the expression $\Delta T = \frac{j_q}{\alpha} \approx 0.007K$. Consequently, the actual gradient on the 7 nm thick membrane amounts to 10^6 K/m, which is a remarkable large value! It is well above the natural heat-flow induced by metabolism, which is only $j_{qcell} \approx 1.5 \cdot 10^{-3} \frac{W}{m^2}$ causing negligible ($\Delta T \approx 7.5 \cdot 10^{-8} K$) temperature difference at the cell membrane.

However, the energy-absorption heating can not be the only effect of the environmental electrosmog. Good example of the non-thermal effects of non-ionizing electromagnetic radiation for living objects, that the electric field itself (without gain the temperature [10]) has long ago recognized [11] advantages to treat humans.

Electrosmog effects in agriculture

The 400 kV/50 Hz power line generated electrosmog effect on the plough-land-plants and give a hint for the practical applications. The studied plant-material samples are collected in statistically significant number by gradient method from the fields for the appropriate investigations. Effects of the changing electromagnetic fields were evaluated on by the application value of the final product. Investigations till now are not satisfactorily enough to establish significant connection between the electromagnetic effects of the actual power-line or the other electromagnetic sources (telecommunication antennas, relay-systems, radar- and orientation systems, etc.), and the physiology parameters of the plants, but the laboratory results give presumptive evidence for the effect. The primary and direct electromagnetic effect on the agrestial plant cultures is expected at the high-voltage power lines crossing the plough-land, (low-frequency fields, 50/60 Hz).

The more than 100 years observations note positive effects. The first scientific observation was in 1903 by Ewart [12]. He described the protoplasm deceleration, slowing-down or many times stopped movements *Valisneria* and *Chara* in magnetic fields. Similar observations were made in the repeated experiments, as well as the accelerated root-development and the membrane water-permeability of plant-cells also were described [12]. The systemic research was started only about 30 years ago. The magnetic field increased the yield of the tomato and promotes its maturation, gained the root-development of rye and wheat, and booted the germination of wheat and maize [12]. The so called magnetic tropism was also described: the growth of roots were directed to the magnetic field at corn, oat, lettuce and sunflower [12].

The electromagnetic stimulus is frequently used [13], but these effects are more hypothetic and historic as would be accepted in the scientific community. One of the most serious investigation

[14] studied 74 various plants showing, that the not sharp parts of the plants were not hurted even by 52 kV/m electric field, however the sharp details or edges start to be damaged at 25 kV/m field strength. In the 2m heights the fields in the argestial areas were not over 8, 12 és 16 kV/m field strength at 345, 735 and 1500 kV-power-lines, respectively. Consequently the electromagnetic effects on the agrestial plants could not be risky.

The observations were orienting the research on the plant metabolism/catabolism and on the bating of seeds [15]. About 20 years ago the investigations of the high-voltage power-line effects were expanded to a wide area, including the humans and the molecular and genetic effects of any living objects. [16], [17]. Due to the extended research, among the actual conditions and accuracy negative effects were not observed [18], [19], [20], [21]; only a small gain in the ionic-exchange (K, Ca and P) was shown [22]. The electromagnetic effects accompanied with irrigation were positive on the vegetation [23] [24]; and furthermore the increased efficacy of herbicides also was described [25].

The effect of the high-voltage power-lines had no observed effect on the ecologic system in agriculture, but the sensitivity of the plants on the electromagnetism varies [26]. The seed stimulation looks one of the most applied and understood phenomena of the field [27] [28] [29]. In some cases the electromagnetism has a transfer-promotion for H⁺-ATPase and Na⁺-K⁺-ATPase, but its mechanism is far from clear yet [30] [31]. It looks sure, that the chain of electron-transport is sensitive for magnetic fields, [32].

Power-line effect on the plough-land-plants

We had studied a 400 kV power-line, crossing the plough-land [33]. The geometry of the arrangement is shown on the figures below. Each cables (R,S,T phases) carry 500-650 A with 350-450 MW effective power. The maximal electric field strength is 7kV/m in the path of the line. The maximal magnetic field was 6-8 μT.

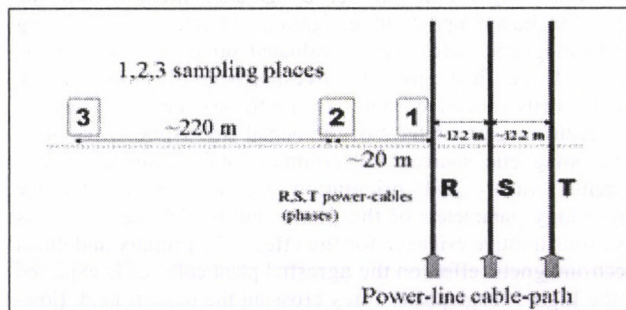
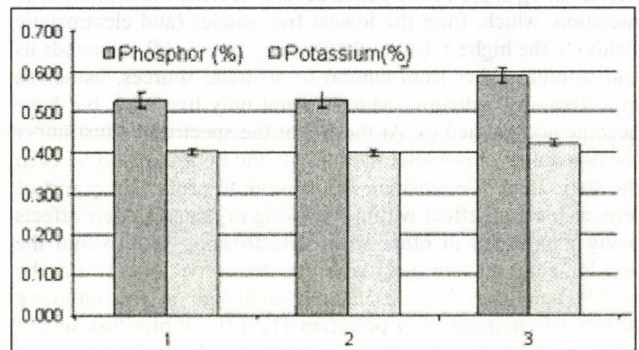
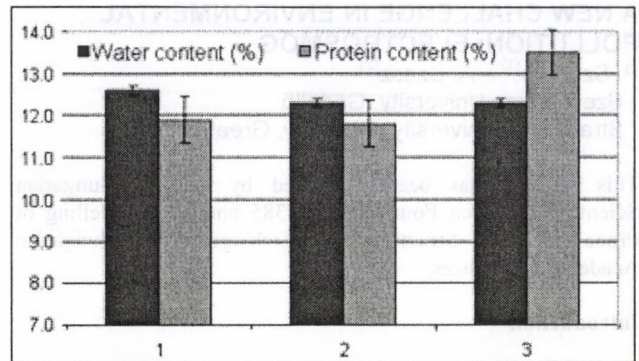

Figure 1

Sampling place number	water-content (%)	protein content (%)	phosphor (%)	potassium (%)
1	12.6	11.9	0.530	0.403
2	12.3	11.8	0.530	0.400
3	12.3	13.5	0.590	0.424

A wheat (named "buzogany") was measured. The seeding was at October 19, 2001, while the harvest was in July 3, 2002. The yield had no any change in the line area by visual observation. The sampling was made at the areas numbered 1-3 in the figure. The measured parameters are summarized in the table. The error did not differ from the standard one. Compared to the control (far away from the line) the water- and potassium contents had no changes, but the protein and phosphorous content were significantly different.



It is important to take attention to the non-direct electromagnetic effects of the power-line. Detailed investigations prove [34], that the dust enriched around the high-voltage power lines absorbs the natural radon emitted from the ground. This natural radioactive source has a nuclear fission, (first of all the Po 214 isotopes are generated), which long-half-life period elements could be incorporated by the vegetation and could enriched in the human food-chain, or directly could be breathed. An other modifying factor of the power-lines is the intensive special bird-life. The bird-cast could have an observable effect on the plants under the lines.

Seed-stimulation with electric field

Seeds sown into the soil do not germinate optimally: many of them are unable to germinate, some of them has more germen. The loss of seeds makes the crop unstable, while the multi-germinating degenerates the vegetation, so both of these make the actual arable incalculable. Surplus seeds to reach the normal plant-density can result in suboptimal arrangement, which can lower the success of the harvest. Physical treatments can modify the water-permeability of the seed-coat and the inner membranes, and can rearrange the water distribution within the seed.

Our goal was to use electromagnetic stimulation to increase seed germination and stabilize the germination properties. We studied how the electromagnetic stimulation affects the germination success and can exploit to improve seed germination properties resulting in higher quality, more reliable seed stock.

The water-permeability of the seed-coat is the primary determinant of a seed's germination-power, and can also influence germ vitality and the eventual green-mass of the plant [35], [36]. The hard-grain ratio of the seed-mass affects germination stability and thus methods for its elimination have been devised [36]. Unfortunately, these methods are typically difficult to control and consume too much energy to be practical. Well controlled glow-discharge, however, can solve both of these problems. (1) Glow-discharge increases seed respiration by delivering high oxygen concentration to the seed, (2) it mechanically creates micro-channels to promote water intake of the seeds through the seed-coat, and (3) it supports electro-osmotic transport processes, thus enhancing water-

transport through the internal membranes, (4) changes the hydrogen-bridge clustering in the electrolytes of the seed to lower its surface tension and promote the membrane permeability, (5) changes the enzymatic processes promote the proper germination. We worked out a theory for all of the described factors.

A spark-discharge is used to create micro-channels through the seed-coat. The applied voltage on the brush electrode was 15–40 kV, at a frequency of 10–500 Hz, with a negative half-period of 0.2–1.5 ms. A vibrating mechanism supplies the seeds to a conveyor belt, which delivers the seeds to a needle-brush electrode system, where the conveyor belt itself serves as the counter electrode. A container then collects the treated seeds.

Treatments of various seeds were carried out. The treatment time (effective time in the glow-discharge plasma) was varied, and in most cases a definite optimum was found in between 5–15 s. Some results are summarized in table shown.

Name of seeds	Germination of seeds [%]	
	control	stimulated
Allium cepa	77	86
Carthamus tinctorius	26	68
Triticum spp.	80	96
Hordeum vulgare	75	95
Sorghum sudanense	85	93
Nicotiana tabacum	22	40

Seed-stimulation with magnetic field

Water state is defined by hydrogen-bridge density (clustering) and therefore surface tension and self-diffusion. Water clusters (hydrogen-bonds) are quantum-mechanical objects, which could be described with the actual Hamiltonian, containing the scalar and vector potential of the external electromagnetic field. Water-states can be modified by a well chosen magnetic field (vector potential). The water polarization depends on the external electric field and its waveform.

A magnetic field was applied to various seeds moving through a solenoid (Figure 2/1). The coil was supplied by a spark-discharge (Figure 2/4) and electronics (Figure 2/2,3,5) with a collector and transport system (Figure 2/6,7,8,9) controlled by computer. A bifilar coil (curl-free vector-potential without a measurable magnetic field) was also applied during certain experiments to assess quantum-mechanical effects. The

germination power of control and treated cells were subsequently measured.

Although our results require further statistical analyses, our preliminary findings indicated that magnetic field stimulation can be used to increase the germination power of various seeds. Our bifilar coil studies also indicated that a vector potential alone can also elicit biological changes. Further studies on the effects of magnetic fields on seed germination are in progress.

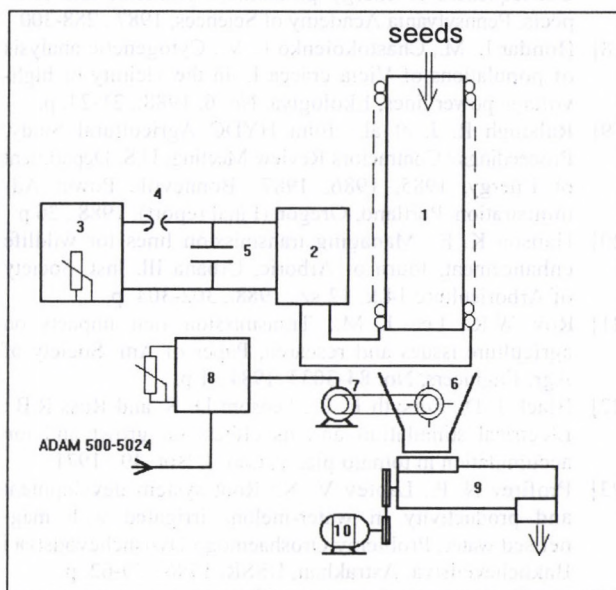

Figure 2
Schematics of the magnetic field applicator

Seeds	Treatment time [s]	Germination power [%]		Remark
		Control	Treated	
Onion	15	77.0	86.0	
Carrot	15	6.0	11.0	
Carthamus	5	25.7	68.3	
	10		67.0	
	15		67.3	
Horse-radish	15	93.0	97.5	
	20		96.0	
Wheat	30	80.0	96.0	solenoid
			96.0	bifilar
			93.0	solenoid
Barley	30	75.0	95.0	bifilar
			93.0	
Sudan grass	15	85.0	93.0	

References

[1] A. Varga: Elektrobioklimatologie 1981. Verlag für Medizin Dr. E. Fischer GmbH, Heidelberg Verlags-Nr.
 [2] Becker: Cross Currents, Jeremy P. Tarcher, Inc. Los Angeles, 1990
 [3] F. Bistolfi: Biostructures and radiation order disorder, Edizioni Minerva Medica, Torino, 1991
 [4] M. Fritsch: Ein Leben unter Spannung 1993. Priv. Institut für baubiologische Anwendungen
 [5] Szendrő et al: Pink-noise behavior of the bio-system European Biophysics Journal, 30, p 227-231, 2001.
 [6] Szendrő et al: Bio-response on white noise excitation, Electric and Magnetobiology 20, p. 243-257, 2001.
 [7] Szendrő et al: Vektorpotenciál hatása biológiai rendszerekre, MTA-AMB K+F Tanácskozás, Gödöllő, 2002.
 [8] Jackson JD: Classical Electrodynamics, John Wiley & Sons, Inc., New York, 1999

[9] Schwan HP: Frequency Selective Propagation of Extracellular Electrical Stimuli to Intracellular Compartments. In: Non-linear Electrodynamics in Biological Systems. Ed: Adey WR, Lawrence AF, Plenum Press New York and London, 1983.
 [10] The applied power is less than 5 W.
 [11] Martin FH: JAMA 8:61-68 and 8:85-90, 1886 (cited by [10/a]).
 [12] Precman A.C.: Elektromagnitnütö Polja i zsvajva priroda. Akad. Nauk SSSR. 1968, 288 p
 [13] Phirke P. S. Kubde A. B. Umbarkar S. P.: The influence of magnetic field on plant growth. Seed Sci. & Technol. 24, 1996., 375-392. old.
 [14] Klein K. W.: Research into the effects of exposure to high voltage electric fields. Paper of Am. Soc. Of Agricult. Engineers, No. 84-3031, 1984., 10 old.
 [15] Bán I.: Növényi gyakorlati biofizika, Akadémiai Kiadó, Budapest, 1989., 242 p.

- [16] Chapman G.: Methods and practices of installing and maintaining underground distribution in rural areas, Paper presented in the Annual conf. Of Rural Elect. Power Conf. New York, N. Y. Ins of Electrical and Electronics Eng. (28th), 1984., C5/1-C5/11. p.
- [17] Bramle W. C et al.: Management and environmental impacts of electric power transmission rights-of-way, Env. Consequences of energy produktion: problems and prospects, Pennsylvania Academy of Sciences, 1987., 288-300.
- [18] Bondar L. M., Chastokolenko L. V.: Cytogenetic analysis of populations of *Vicia cracca* L.-in the vicinity of high-voltage power lines, *Ekologiya*, No. 6, 1988., 21-24. p.
- [19] Ralsingh R. J. et al.: Joint HYDC Agricultural Study, Proceedings / Contractors Review Meeting, U.S. Department of Energy, 1985, 1986, 1987., Bonneville Power Administration, Portland, Oregon (Final report), 1988., 26 p.
- [20] Hanson K. E.: Managing transmission lines for wildlife enhancement, *Journ of Arboric, Urbana Ill. Inst. Society of Arboriculture* 14.k. 12.sz., 1988., 302-304. p.
- [21] Roy W.R., Lee J. M.: Transmission lien impacts on agriculture issues and research, Paper of Am. Society of Agr. Engineers, No. 84-3033, 1984., 1 p.
- [22] Black J. D., Forsyth F. R., Fensom D. S. and Ross R.B.: Electrical stimulation and its effects on growt and ion accumulation in tomato plants, *Can. J. Bot.* 49., 1971
- [23] Profirev N. P., Laptev V. N.: Root system development and productivity in water-melons irrigated with magnetised water, *Problemy Oroshaemogo Ovoshchevodstva i Bakhchevodstva, Astrakhan, USSR*, 1986., 59-62. p.
- [24] Lin I., Yotvat J.: Exposure of irrigation water to a magnetic field with controlled power and direction: effects on grapefruit, *Alon-Hanotea*, 43. évf., No. 6, 1989., 669-674. p
- [25] Dreyer G. D., Niering W. A.: Evolution of two herbicide techiques on electric transmission rights-ofway: development of relatively stable shrublands *Environm. Management*, 10. évf., No. 1, 1986., 113-122. p
- [26] Petrasovits I.: A nagyfeszültségű elektromágneses terek mezőgazdasági környezeti hatásairól, OTKA tanulmány, Gödöllő, 1994
- [27] Jones D. B. and McLeod B.: Electromagnetic cell stimulation. In: Lynch, P.T. and Davey, M.R. (eds.) *Electrical Manipulation of Cells*, Chapman & Hall, London, 1996., 223-247. p
- [28] Pirke P. S., Kubde A. B. and Umbarkar S. P.: The influence of magnetic field on plant growth. *Seed Sci. & Technol.*, No. 24, 1996., 375-392. p
- [29] Zhang h. and Hashinaga F.: Effect of high electric fields on the germination and early growth of some vegetable seed, *J. Japan. Soc. Hort. Sci.* No 66, 1997., 347-352. p
- [30] Blank M. and Soo L.: The threshold for interaction of magnetic fields with the Na,K-ATPase, *Bioelectrochem. Bioenerg.*, No. 40, 1996., 63-65. p
- [31] Plätzer K., Obermeyer G. and Bentrup F.-W.: AC fields of low frequency and amplitude stimulate pollen tube growth possibly via stimulation of the plasma membrane proton pump., *Bioelectrochemistry and Bioenergetics*, No. 44, 1997., 95-102. p
- [32] Soja G., Giczi A., Soja M. and Kunsch B.: Use of ANNs in a plant-based test system for biological effects of low frequency electric and magnetic fields, *IC-AI '2000 International Conference, Las Vegas, Nevada, USA. June 26-29, 2000.*, 55-61. p
- [33] Location: Paks-Sándorfalva, Hungary, 23.-26. backing of the 400kV power line
- [34] Fewes A.P., Henshaw D.L., Keitch P.A., Close J.J., Wilding R.J.: *Int. J. Radiat. Biol* 1999, vol 75, No. 12, 1505-1521
- [35] Matthews+: *Proc. Int. Seed Test. Ass.* 32:553-563, 1967;
- [36] Mohsenin: *Electromagnetic Radiation Properties of Foods and Agricultural Products*, Gordon and Breach Publishers, New York, 1984;

Contents of N° 16/2003

THE STATIC AND DYNAMIC GROUND PRESSURE OF CASE IH QUADTRAC RUBBER BELT TYPE TRACTOR I. J. Jóri ¹ – Zs. Farkas ¹ – Gy. Kerényi ¹ – M. Szente ² – G. Antos ³ ¹ Budapest University of Technology and Economics ² Hungarian Institute of Agricultural Engineering, Gödöllő ³ Integrated Crop Production System (IKR, Bábolna)..... 12	APPLICATION OF PRISMS FOR SOLAR COLLECTORS I. Patay – Gy. Babák Tessedik Sámuel College, Szarvas 54
INFLUENCE OF THE FRONT AXLE SPRINGING TO THE TRACTOR DRAWING PARAMETERS M. Szente – Zs. Kassai Non-profit Co. of HIAE for QT., Gödöllő 14	COMPARATIVE ENGINE TESTS AND ENVIRONMENTAL EFFECT ANALYSIS OF FUELS MADE OF ANIMAL FAT AND VARIOUS KINDS OF PLANT OILS L. Jánosi ¹ – J. Hancsók ² – F. Kovács ² ¹ Szent István University, Gödöllő ² University of Veszprém 57
EFFECT OF BIOLOGICAL PRESERVATIVES ON THE QUALITY OF SILAGE PRESERVED IN PLASTIC TUBE (OTKA T 030031) Z. Bellus ¹ – J. Csemely ¹ – J. Schmidt ² ¹ Hungarian Institute of Agricultural Engineering, Gödöllő ² University of West Hungary, Mosonmagyaróvár..... 16	RENEWABLE ENERGY FROM HAZARDOUS ORGANIC WASTE K. Kovács ^{1,2} – I. Kalmár ³ – Z. Bagi ^{1,2} – P. Valastyán ⁴ , ¹ University of Szeged ² Institute of Biophysics, Biological Researcher Center, Hungarian Academy of Sciences, Szeged ³ Tessedik Samuel College, Mezőtúr ⁴ Unicotech Kht., Szeged 61
THE DEVELOPMENT OF DRYING TECHNOLOGIES M. Herdovics Hungarian Institute of Agricultural Engineering, Gödöllő..... 19	DOMESTIC EXPERIENCES OF OPERATING WIND GENERATORS L. Tóth – G. Horváth – G. Tóth – N. Schrempf – L. Fogarasi Szent István University, Gödöllő..... 63
COMPARISON OF BALE WRAPPING MACHINES Z. Bellus Hungarian Institute of Agricultural Engineering, Gödöllő..... 21	ENERGETIC MODELLING OF WHEAT KERNEL HARDNESS A. Véha – E. Gyimes Szeged University 66
ON DETERMINATION OF THE HEAT CONDUCTIVITY OF CEREALS AND AGRICULTURAL GRIST MATERIALS E. Judák – G. Kovács – L. Fogarasi – P. Korzenszky Szent István University, Gödöllő..... 25	INFLUENCE OF LOAD ON THE FRICTION COEFFICIENT BETWEEN STEEL AND POLYAMIDE ROLLING COUPLES R. Cotetiu ¹ – A. Cotetiu ¹ – O. Eberst ¹ – G. Kalácska ² ¹ North University of Baia Mare, Romania ² Szent István University, Gödöllő 68
DETECTION OF SMALL SCALE MECHANICAL CHANGES BY ACOUSTIC MEASURING SYSTEM J. Felföldi – A. Fekete BKAE University, Faculty of Food Science, Budapest 28	THE APPLICATION OF THE BENCHMARKING METHODS FOR RATIONALISING THE LOGISTICAL COSTS OF THE AGRICULTURAL MACHINERY A. Tátrai Business College of Budapest..... 72
SOME PROPERTIES OF PARSLEY LEAVES DRYING J. Beke Szent István University, Gödöllő..... 30	THE POTENTIALS AND LIMITATIONS OF JUST IN TIME (JIT) J. Benkő Szent István University, Gödöllő..... 74
APPRECIATION OF AN COMPLEX ULTRASOUND SYSTEM ACCORDING TO THE SURVIVAL CELL COUNT A. Lőrincz – M. Neményi University of West Hungary, Mosonmagyaróvár..... 32	OPERATION FEATURES OF PNEUMATICALLY CONTROLLED LINEAR CYLINDER IN THE WIEV OF ENERGY SAVING Zs. Bartus – L. Jánosi Szent István University, Gödöllő..... 77
PHISICAL PROPERTIES OF SEEDS OF VEGETABLES N. I. Polyák - Z. Csizmazia Centre of Agricultural Sciences University of Debrecen 35	STUDIES ON THE DINAMICS OF TRUNK SHAKERS E. Horváth Szent István University, Faculty of Horticultural Science, Budapest 81
THE ENERGY BALANCE METHOD OF CHARACTERIZING SPRAYS FROM HYDRAULIC NOZZLES I. Sztachó-Pekári College of Kecskemét 38	INCREASING THE RAW MATERIAL BASIS OF BIO-BRIQUETTE PRODUCTION BY USING NEW MATERIALS B. Marosvölgyi – D.I. A. Vityi – R. Ivelics – L. Szűcs Szabó University of West Hungary, Sopron..... 84
ALTERNATIVES OF THE DOMESTIC AGRICULTURAL MACHINERY MARKET J. Hajdú – L. Magó Hungarian Institute of Agricultural Engineering, Gödöllő..... 41	QFD METHOD ADOPTION TO SELECT SOIL TILLAGE SYSTEMS M. Birkás ¹ – L. Csík ² ¹ Szent István University, Gödöllő ² MEZŐGÉP Ltd..... 86
CHANGES IN SOME INDICES OF CAPITAL EFFICIENCY OF FARMS, SPECIALITY OF REGIONS I. Takács Szent István University, Gödöllő..... 44	A NEW CHALLENGE IN ENVIRONMENTAL POLLUTION: ELECTROSMOG P. Szendrő ¹ – A. Szasz ² ¹ Szent István University, Gödöllő ² Strathclyde University, Glasgow, Great-Britain..... 89
WASTE MANAGAMENT IN THE WOOD PRODUCT INDUSTRY M. Varga – G. Németh University of West Hungary, Sopron..... 47	
EXAMINATION OF FALSE HEARTWOOD FORMING IN BEECH TREE IN THE WOODS OF SEFAG RT. J. Rumpf – B. Biró University of West Hungary, Sopron..... 52	

Contents of the
“Mezőgazdasági Technika”
 periodical of the year 2003.

MEZŐGAZDASÁGI
TECHNIKA
 2100 GÖDÖLLŐ, TESSEDIK S.U.4.

N° 1

New results of the mechanization research for the energy-forest harvesting in Hungary (B. Marosvölgyi – A. Kürtösi – J. Püske)2

Novelties from EIMA Garden 2002, Bologna (J. Hajdú)4

Winter operation of tractors and lorries (V. Varga)23

Special aspects of TQM in agriculture (I. Husti)35

Selection of the best cultivation system by QFD method (M. Birkás – L. Csík)40

N° 2

The role, the situation and the task of the technical background of agriculture in the connection process to EU (I. Németh)2

The static and dynamic ground pressure of the Case IH 9370 Quadtrac rubber belt tractor (I. Jóri J. – Gy. Kerényi – Zs. Farkas)6

Feeding tools for organic-acid (Gy. Komka)31

New developments for agri-tires (G. Antos)53

The survey of milking robots can be found on the european market (D. Motika – R. Francia – L. Tóth)58

Machinery cost for 2003 (L. Gockler)61

N° 3

AGRO+MASHEXPO 2003 (J. Hajdú – A. Horváth – G. Pálincás)1

Prism applying to optical sun-collector (I. Patay – Gy. Babák)2

Can be follow the production process in the agriculture – Challenges and possibilities (Z. Láng)4

Expert's visit in the Zweibrücken factory of John Deere (G. Pálincás)6

Air filters for tractors (V. Varga)21

AGROMEK 2003 (J. Hajdú)36

Campbell-„fever” in Hungary Part II (M. Birkás)39

N° 4

Real spread pattern with N-and complex fertilizer by ballistic phenomena (Á. Gindert-Kele)2

User-friendly PC model of machines (J. Janik – I. Zsoldos – I. Pálincás)15

Potato planter (J. Fűzy)21

AGRO+MASHEXPO 2003 (A. Horváth – G. Pálincás)33

X. Machinery Day at Derecske – Meeting and field show of KASZ-COOP company (S. Soós)36

SIMA 2003. Paris (J. Hajdú)42

N° 5

The energetic comparison of the single-and double acting sun-collector systems (Z. Láng)2

Quality wheat production in the Pannon region (Gy. Tátrai – J. Hajdú)15

The Rollers (S. Soós)21

The machine investment of hungarian agriculture in 2002. (J. Hajdú)32

Hillside combine harvester-„The good price buying” (I. Sörös)36

The situation of agricultural machine stock in Hungary at the EU connection time (L. Gockler)41

N° 6

The 30th anniversary of Crop Production Systems (A. Horváth)1

Wind energy and the agriculture (G. Tóth)2

Multipurpose haymaking equipments (Zs. Kelemen)21

The change of the machine park's power and operational cost based on the data of MGI's basic farms (L. Gockler)33

The lessons of the anti-plough movement (1920-1930) Part 1. (M. Birkás)36

The combine harvester's world – the combine havesters of the world (J. Hajdú)40

N° 7

The experimental evaluation of the transport process at the parsley leaf drying (J. Beke)2

Agricultural machinery on the Agro 2003, Kiev (J. Hajdú)12

The overview of West European tractor market (J. Hajdú)20

Wind motors, wind generators (L. Tóth)27

The main direction of agricultural machinery development and its economical effects. Part 1. (L. Gockler)43

The 8th „Alföldi” Crop Production Days (A. Horváth – G. Pálincás – S. Soós)48

The lessons of anti-plough movement (1920-1930). Part 2. (M. Birkás)53

N° 8

The comparison of convection and micro-wave drying process of carrot and tomato samples (G. Bihercz – Z. Kurják)2

Experiences of a Northern Russia study tour (L. Fenyvesi – Gy. Tátrai)6

Manure spreader (Zs. Kassai)29

The Hungarian show of CLAAS novelties (A. Horváth)42

The test results of the CASE-IH and New Holland combine harvesters (Zs. Kelemen – I. Komlódi)49

ATV-a development story from motor bike to tractor (J. Hajdú)54

N° 9

The DFT 1500 fuel additive effects on the operation characteristics of the Perkins 1004-4T diesel engine (T. Mezei)2

Ventilation of farm buildings (I. Pazsiczki)23

Prognostic for agricultural machine market-the predictable development of world machine market (J. Hajdú)37

FarmerExpo at Debrecen (L. Tóth)40

The GRIMME machine-set for bed-type potato production (J. Fűzy – S. Soós)43

N° 10

The comparison of fruit-tree shapes by suitability for the shaker type harvesting (Z. Láng – L. Csorba)2

Evaluation of the corn drying process (J. Csermely – M. Herdovics)5

AGCO Machinenshow of newest development (G. Pálincás)12

The self-loading wagons with transporter (Zs. Kelemen)23

Farm Progress Show of Bábolna (A. Horváth – G. Pálincás)34

Horticultural Show of KITE (J. Hajdú)38

N° 11

The improvement of spreading uniformity (CV) of the manure spreaders (Zs. Kassai)2

The new generation of New Holland Braud grape harvesters (A. Horváth)14

The seed loss monitors (I. Bognár)23

Tillage 2003 – the soil cultivation show in England (M. Birkás)32

The Fendt tractor novelties (A. Horváth)36

JD – Technology that pays (G. Pálincás)42

N° 12

Heat treatment operations in fodder-mixture production (J. Csermely – M. Herdovics – Gy. Komka)2

Potato storage machines (J. Fűzy)21

Innovations of AGRITECHNICA 2003 (J. Hajdú)32

Recent data on machine park of agriculture (L. Gockler)38

In memoriam Ede Kühne (Gy. Réz)42

Do you want to know more from
Hungarian Agriculture Machinery!

SENDTMS ORDER FROM TO:

The Hungarian Agricultural Machinery Journal
H-2001 Gödöllő, Tessedik Sámuel u. 4.

ORDER FORM

I want order the Hungarian Agriculture Machinery Journal
from day month 200.....

The subscription fee: 3240 HUF

Name:

Adress:

Code, City:

Country:

Date: day month 200.....

.....

signature

Do you want to know more from
Hungarian Agricultural Machinery?

SEND THIS ORDER FROM TO:

The Hungarian Agricultural Machinery Journal
11-2001 Góddóly, Tiszadob, Hungary

ORDER FOR:

I want to receive the Hungarian Agricultural Machinery Journal

for _____ months

at the rate of _____

Name

Address

City

Country

Phone

11-2001

