

HUNGARIAN

AGRICULTURAL

ENGINEERING

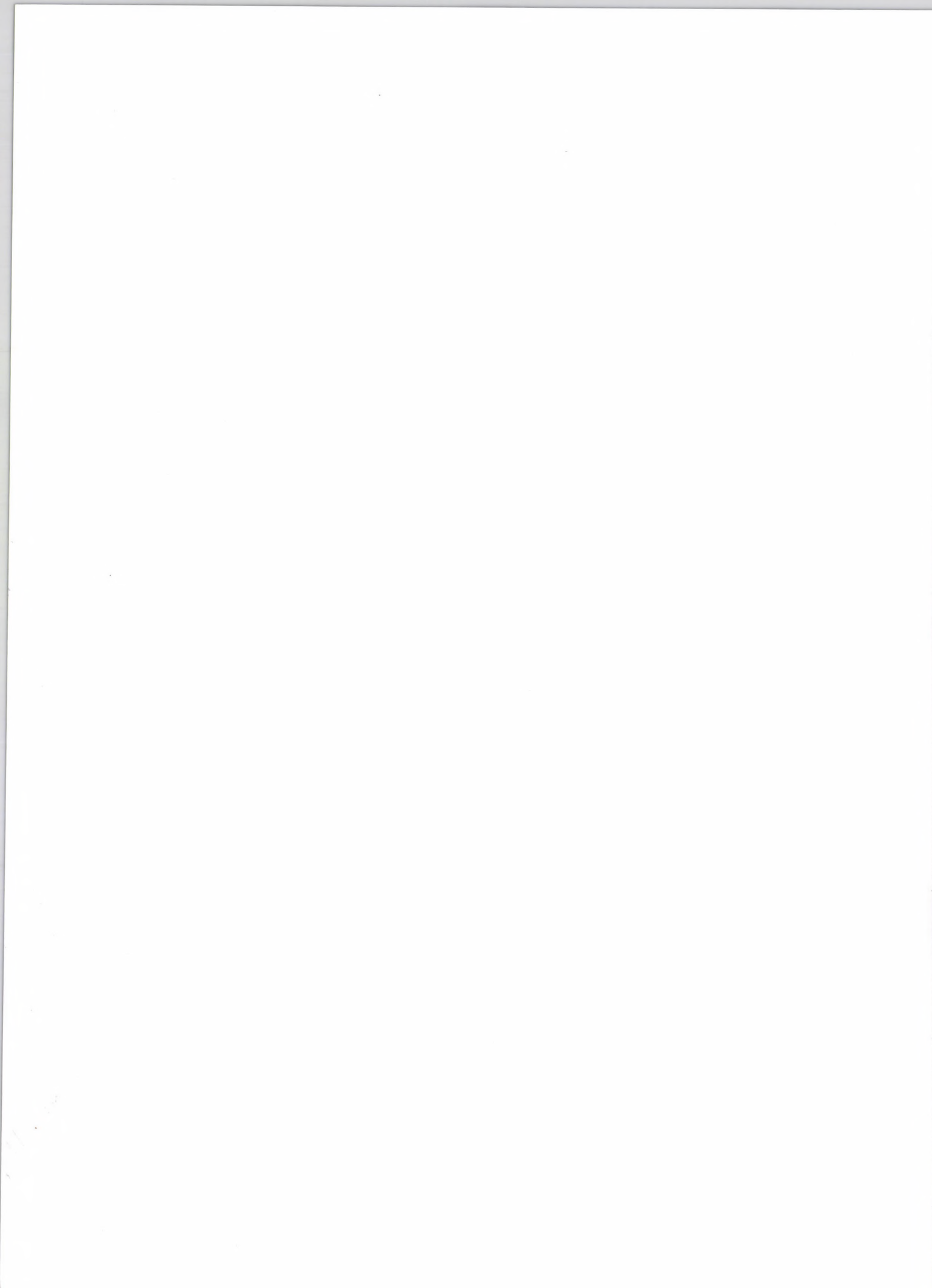





Hungarian Agricultural Engineering

N^o 26/2014

Editors-in-Chief:
Dr. László TÓTH
Dr. István SZABÓ

Managing Editor:
Dr. Csaba FOGARASSY

Secretary of Editorial board:
Dr. László MAGÓ

Editorial Board:

Dr. Imre DIMÉNY
Dr. György SITKEI
Dr. Gábor KESZTHELYI-SZABÓ
Dr. László TÓTH
Dr. János BEKE
Dr. István SZABÓ
Dr. István J. JÓRI
Dr. Béla HORVÁTH
Dr. Péter SEMBERY
Dr. László FENYVESI
Dr. Csaba FOGARASSY
Dr. Zoltán BÁRTFAI
Dr. László MAGÓ
Dr. Bahattin AKDEMIR ✓
Dr. R. Cengiz AKDENIZ ✓
Dr. József NYERS ✓
Dr. Míco V. OLJAČA ✓
Dr. Zdenek PASTOREK ✓
Dr. Vijaya G.S. RAGHAVAN ✓
Dr. Lazar SAVIN ✓
Dr. Bart SONCK ✓
Dr. Goran TOPISIROVIĆ ✓
Dr. Valentin VLADUT ✓

ON
PERIODICAL OF THE COMMITTEE OF
and Biosystem
AGRICULTURAL ENGINEERING OF
THE
HUNGARIAN ACADEMY OF SCIENCES

Published by

Szent István University, Gödöllő
Faculty of Mechanical Engineering
H-2103 Gödöllő, Páter K. u. 1.



and the
Szent Istvan University
Climate Council

Gödöllő
2014

Published online: <http://hae-journals.org>
HU ISSN 0864-7410 (Print)
HU ISSN 2415-9751(Online)

PREFACE

In the name of the Committee on Agricultural and Biosystem Engineering within the Hungarian Academy of Sciences' Section of Agricultural Sciences we would like to welcome everyone who is interested in reading our journal. The Hungarian Agricultural Engineering (HAE) journal was published 27 years ago for the very first time with an aim to introduce the most valuable and internationally recognized (DOI numbered) Hungarian studies about mechanization in the field of agriculture. Initially the "Hungarian Institute of Agricultural Engineering" was responsible for the publication of the magazine which mostly based on the articles and the presentations of the annually organized International Mechanization Conference. Later on – thanks to these international meetings – we were able to publish the researches of experts from different international universities. Basically we used the printed paper form to publish our journal and distribute amongst the libraries of well-known Hungarian and international research centers and to everyone who subscribed for it. In the year of 2014 the drafting committee decided to spread it also in electronic (on-line) edition and make it entirely international. After that the Szent István University's Faculty of Mechanical Engineering took the responsibility to publish the paper in cooperation with the Hungarian Academy of Sciences. Our goal is to occasionally report the most recent researches regarding mechanization in agricultural sciences (agricultural and environmental technology and chemistry, livestock, crop production, feed and food processing, agricultural and environmental economics and energy) with the help of several authors. The drafting committee has been established with the involvement of outstanding Hungarian researchers who are recognized on international level as well. We hope that our journal provides with accurate information for the international scientific community and serves the aim of the Hungarian agricultural engineering research and development.

Gödöllő, 15.12.2014.

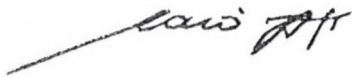

Dr. István SZABÓ
editor in chief

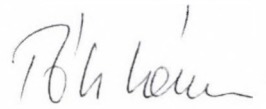

Dr. László TÓTH
editor in chief

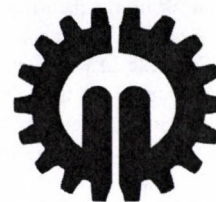

EXTERNALITY ANALYSIS OF SUSTAINABLE CATTLE BREEDING SYSTEMS

Author(s):

Cs. Fogarassy – M. Bakosné Böröcz

Affiliation:

Szent István University, Faculty of Economics and Social Sciences,
Institute of Regional Economics and Rural Development., 1. Páter Károly street, Gödöllő, 2100, Hungary

Email address:

Fogarassy.Csaba@gtk.szie.hu, Borocz.Maria@gtk.szie.hu

Abstract

In Hungary, extensive beef production has a very long tradition. The importance of sustainability in agriculture is unquestionable, as it generates externalities as a by-product, which is to be managed. The problem of sustainability in agriculture could be handled long-term by extensive farming. According to [1] J.K. Bithas (2011), sustainable development requires a sufficiently long time period of consideration to cover the interests of generations even far in the future. Environmental impacts and the relevant environmental externalities inhibit the prospect of sustainability. Hence, externality is a key concept for sustainability. In our research, we highlighted the relevance of extensive cattle-breeding systems from a sustainability aspect.

Keywords

sustainable agriculture, extensive farming systems, benchmarking, externality

1. Introduction

The export of Hungarian livestock and beef was significant until the 80's. However, the number of livestock is continuously decreasing nowadays, including the number of beef cattle as well. The reasons for this decrease were international and domestic, economic and social changes. The BSE epidemic in the 90's, the funding system for the beef sector, the elevated competition and the level of saturation on the international market all had negative effects on the sector. Due to extensive production, and cattle raised on grasslands, beef of good quality can be produced, which may serve as a basis for health prevention in the future. This kind of technology meets the criteria of sustainability, since the animals are fed with natural food, their diet doesn't include tankage that would lead to diseases. If we're searching for the connection between sustainability and the externalities, we can think back on Van de Bergh[2], who describes this connection as follows; if we internalize all externalities, which are inconsistent with sustainability, will we realize sustainable development. Van de Bergh [2] states: „Without environmental externalities, the problem of unsustainability vanishes”. According to Bithas [1] environmental impacts cause environmental externalities, so they have extensive physical dimensions time- and space-wise. The problem of sustainability is mainly related to environmental

impacts that affect future generations and individuals in geographically distant locations. Van de Bergh [2] concludes that sustainability is compatible with a positive level of externalities, defined by the assimilation capacity of the environment, and the technological status.

2. Materials and methods

In our research, we used benchmarking to validate our hypotheses that extensive farming systems have less externalities compared to intensive systems. Benchmarking originates from Robert C. Camp [3], facilitating the spread of the benchmarking method. According to Camp [3] benchmarking means the discovery and realization of the never-failing best practices. Evans [4] says that benchmarking is a leadership tool, and if we use it, we can find the best business practices leading to performances of the highest level. It provides information which lets us view what we currently lack, thus helping to achieve the goals we set for ourselves.

Management has taken the expression 'benchmark' from surveying and architecture: it refers to a column made of stone with which other points correlate. The original meaning of the word is simply 'level of height'. According to Pálfalvi [5], we may call also this a level-improvement, since it is about defining where the target firm is compared to the others on the market, and what we need to do to improve its status, and develop its adaptability. To identify and examine the externalities of cattle breeding systems, benchmarking is a good solution, since externalities in agricultural production can be evaluated with this method.

In our research, we've investigated the impacts of different technologies on Hungary's meat-cattle sector. The information sources we used for the benchmarking analysis were professional sources, professional publications and statistics. We've carried out our investigations by combining the elements of functional- and process-based benchmarking. During the benchmarking, several questions can be raised: what should the aim of the analysis be, what the company and the sector should be compared to, etc. The information sources of benchmarking can be professional associations, chambers, experts, colleagues, suppliers, clients, professional magazines, publications, databanks, relationships and product analyses. According to Pigou [6] "An externality occurs in economics when a decision causes costs or benefits to stakeholders other than the person

making the decision. In other words, the decision-maker does not bear all of the costs or reap all of the benefits from his action. As a result, in a competitive market, too much or too little of the good is consumed from the point of view of society.” We examined the intensive and extensive farming systems in light of externalities, searching for the most sustainable variant of cattle-breeding farming.

During our analyses, we defined traditional technologies as an intensive/semi-intensive technology, where animals are kept in closed buildings, and large amounts of supplementary fodder are consumed. Intensive farming isn't widely used in Hungary, because it includes grazing as well, albeit to a much lesser extent compared to extensive or ecological farming [7]. We considered extensive farming to be when the animals mainly graze. They get supplementary feed, but much less compared to conventional technology. In this case however, we can't achieve the same volume of daily weight increase. Regarding ecological farming, feeding is primarily based on grasslands, but supplementary fodder also has to come from ecological farms, which causes the costs to increase. Ecological breeding is used mostly for Hungarian grey stock, since it tolerates extreme weather conditions quite well. It doesn't have high demands, but its reproduction capacity is lower than that of others [8].

During the benchmarking analysis, we have defined three aspects, based on the different technologies which we examined. These were the following: ecological, economic and technological. Within those aspects, we have analyzed 10 indicators in each case [9]. We have selected 10 indicators,

because we intended to have a balance between the different aspects, since they have the same significance. We specified the indicators, after which we selected a base indicator, and assigned a performance indicator to it. In both cases, we explained the actuality of the selection. As for the different technologies, different impacts have to be considered. Therefore, this method was suitable for ranking the different possible solutions. The basis for defining the aspects and carrying out the research was professional sources, and my own examinations.

In the next part, we will give an example through animal manure to explain how we defined the status-, and performance indicators.

Status indicator

Dealing with manure created (Technological aspect: 6)

Reason for selecting the indicator: The quantity and quality of manure, and possible ways of its usage vary for different technologies. Liquid manure causes a lot of environmental problems. In ecological breeding, mainly the Hungarian grey is used, due to its frugality, thus its manure doesn't need any special treatment. This is also true for extensive breeding, since the nutrition content of the manure is absorbed by the grassland.

In conventional technology, the created manure (45 kg/animal) has to be transported and treated if necessary, meaning extra costs for the farmers.

The amount of manure created by cattle is summarized in Chart 1:

Chart 1. Manure of cattle
Source: Nyiri, [10]

Livestock	Fecal (kg)	Urine (kg)
Cattle:	20,0-30,0	10,-15,0

Performance indicator

Creation and treatment of manure according to different technologies: different amounts of manure have to be calculated by the farmers depending on the technology applied. Liquid manure is very dangerous for the environment, so having to dispose of it is inevitable.

Method for performance qualification: The amount of manure which has to be treated per animal.

The scale of my assessment was between (-2) and (+2):

(-2) extremely unfavorable effect: over 30 liters/animal daily

(-1) unfavorable effect: over 20 liters/animal daily

(0) no effect: average 15-20 liters/animal daily

(+1) favorable effect: less than 15 liters/animal daily

(+2) extremely favorable effect: less than 12 liters/animal daily

In this analysis, conventional technology got (-2), extensive and ecological ones got (+1), since the amount of manure is not significant in the cases of the extensive and ecological systems.

Following the above mentioned logic, according to the environmental aspects we can demonstrate the reason for selecting the indicator in the next way. If we have environmental status indicator „Utilizing environmentally sensitive lands” we can use as a performance indicator „Changes in the size of lands involved”. In this context we analyzed the size of the involved environmental sensitive lands and we can state, that we can expand the grazing animal keeping extensive systems in this type of lands. We gave (-1) for the intensive system, since in this kind of lands there are strict regulations which have to be taken to

consider. We gave (+2) for the extensive and ecological ones since extensive farming systems can use this kind of lands.

When we analyze the status indicator „Possibility to open towards new sales channels” in the case of economic aspects we chose performance indicator „Trends of the market demand”. We gave (+2) for the intensive system, since in this kind products could be made in lower price than the ecological products, therefore it is easier to enter to the market for them. We gave (0) for the extensive and (-2) ecological systems, since the market demand for the ecological products depends significantly from the solvent request of the people, and the marketing instruments.

During benchmarking, the products, services, and processes can be compared to each other in a way that the reasons for differences in performance can also be seen, and they highlight the possibilities for improvement. We have prepared the analysis based on such considerations, to examine the shortcomings and possibilities of each technology [11]. As a first step, we defined the elements of the Logframe - matrix. It helps us to see the logical relationship between the activities, results and goals. The cells of the Logframe - matrix are built on each other both vertically and horizontally.

Logframe- matrix

The Logframe Matrix (LFA) is a chart that includes the aims, the methods and indicators of control, and their necessary conditions (Chart 2).

Chart 2. Logframe matrix for evaluation
Source: Bakosné [11]

	Aims	Indicators	Control	External conditions
Output	To discover externalities related to meat-cattle production	Environmental, economic and technological features	Summarizing the positive and negative external effects	Regulatory environment, market acceptability
Direct impact	Resource-efficient farming methods, ecological-extensive cattle breeding, taking environmental economic aspects into consideration-protection of water base	Volume of manual labor and energy, newcomers of the extensification program, improving environmental conditions	Analyzing changes in the environment, examination of market viability	The higher costs must be accepted by the market, cooperation of consumers, information
Indirect impact	Levying tax on the sources of negative externalities, supporting the sources of positive externalities	Defining the volume of support, controlling innovation capacity, examination of supply and demand reactions	Examination of support- and tax system	Recognizing positive and negative externalities in the right way

3. Results and discussion

The results can be evaluated with the help of the indicators, comparing them to the goals. We defined three types of indicators:

1. indicators of environmental aspects (Chart 3)
2. indicators of technological aspects (Chart 4)
3. indicators of economic aspects (Chart 5)

Chart 3. Indicators of environmental aspects
Source: Bakosné [11]

Environmental aspects			
Code	Status indicators	Code	Performance indicators
1.	Effects related to soil contamination	1.	The change in the quantity of materials contaminating the soil.
2.	Spread of farming methods adapted to landscape	2.	Changes in the sizes of extensive and ecological agricultural lands.
3.	Utilizing environmentally sensitive lands	3.	Changes in the size of lands involved.
4.	Using grasslands	4.	Changes in the size of grasslands grazed.
5.	In situ effect on natural treasures	5.	Impact on the landscapes.
6.	Maintaining biodiversity	6.	The constitution of the land, activities influencing other varieties.
7.	The amount of waste, handling waste produced	7.	The amount of waste produced by different technologies, and how to handle them.
8.	Handling produced manure	8.	Manure produced and handled by the various technologies.
9.	Necessity of renewable energy sources	9.	Quantity of non-renewable energy sources needed.
10.	Effects related to water contamination	10.	Changes in the amount of materials contaminating the water.

We considered status indicators from an environmental aspect, for example the use of grasslands, utilization of environmentally sensitive lands, or manure management. We also considered

status indicators from a technological aspect, for example water usage, natural resource usage, and asset demand (Chart 4).

Chart 4. Indicators of technological aspects
Source: Bakosné [11]

Technological aspects			
Code	Status indicators	Code	Performance indicators
1.	Energy-conserving technologies	1.	Spread of energy-conserving, green technologies
2.	Efficiency of manpower	2.	Changes in the efficiency of manpower
3.	Keeping the environmental limits	3.	Changes of environmental standards
4.	Greenhouse gas emission	4.	Quantity of greenhouse gases
5.	Water usage	5.	Water used by different technologies
6.	Liquid manure produced using different technologies	6.	Quantity of liquid manure
7.	CO2 economical technologies	7.	CO2 emission reduction
8.	Usage of natural resources	8.	Quantity of natural resources used
9.	Asset demand	9.	Fixed and current assets need
10.	Range of varieties	10.	Number of varieties which can be used

Chart 5. Indicators of economic aspects
Source: Bakosné [11]

Economic aspects			
Code	Status indicators	Code	Performance indicators
1.	Economic subventions	1.	Changes in the volume of support
2.	Environmentally conscious production	2.	Extent of transition to extensive farming
3.	Animal health costs	3.	Costs and their changes
4.	Costs of entering the market	4.	Costs of putting the product on the market
5.	Domestic consumer needs	5.	Ability to meet the domestic demand
6.	Meeting special consumer needs	6.	Ability to meet the special consumer demand
7.	Possible expansion of the product range	7.	Exploiting the product possibilities using a given technology
8.	Possibility to open towards new sales channels	8.	Trends of the market demand
9.	Supplementary forage demand	9.	Need for supplementary forage
10.	Costs related to the maintenance of buildings	10.	Changes in building maintenance costs

We evaluated the results of the benchmarking analysis, by summing up the values of each aspect (the last row of the table). While doing the assessment, we calculated the average of the two extreme values. We considered the value closest to this average to be the optimum.

Based on the evaluation of environmental aspects (Chart 6), we can say that the most positive externalities are accumulated by extensive breeding. Its average value is 6,33. That means that's the case where most positive externalities are created. According to this, the extensive technology generates the highest amount of

positive externalities. On the basis of environmental aspects, conventional technology accumulates the highest number of negative externalities. The extensive group is the closest one to the average value. Conventional technology has negative impacts on in-situ goods and biodiversity. It uses more non-renewable energy resources than the other two technologies. In addition, conventional technology uses a lot of water as well. Extensive and ecological farming are quite close to each other from an environmental point of view. The environmental burden is low in both cases. The transition towards extensive breeding is

encouraged by subsidies because of such environmental effects. Extensive and ecological breeding can be carried out even in environmentally sensitive areas. The amount of liquid manure produced in extensive and ecological breeding is much lower, when compared to conventional practice. There isn't even water produced, therefore it doesn't pollute the soil.

Chart 6. Chart of the evaluation of environmental aspects
Source: self-made

Code	Conventional	Extensive	Ecological
1	0	+1	+2
2	-1	+1	+2
3	-1	+2	+2
4	+1	+2	+2
5	-2	+1	+2
6	-2	+1	+2
7	-1	+1	+1
8	-2	+1	+2
9	-2	+1	+2
10	-1	0	+2
SUM	-11	+11	+19

Chart 7. Chart of evaluation of technological aspects
Source: self-made

Code	Conventional	Extensive	Ecological
1	0	+1	+1
2	+2	0	0
3	+1	+1	+2
4	-1	0	+1
5	-1	0	0
6	-2	+1	+1
7	-1	+1	+2
8	-1	0	+1
9	+1	-1	-1
10	+1	0	-1
SUM	-1	+3	+6

On the basis of technological aspects (Chart 7), extensive farming seemed to be the best regarding energy efficiency and liquid manure creation. Conventional technology accumulated the most externalities regarding this as well. As for the remaining ones, energy use, greenhouse gas emission and the use of natural resources depend on technology applied. And as for the variety, not all varieties are suitable for using in ecological farming. There

is no significant difference between ecological and extensive farming regarding the technological aspects. The average value is 2, 66.

Chart 8. Chart of evaluation of economic aspects
Source: self-made

Code	Conventional	Extensive	Ecological
1	+1	+0	+1
2	+2	+0	+1
3	-2	-1	0
4	+2	+1	-2
5	+2	+1	0
6	+2	0	-2
7	+2	0	-2
8	+2	0	-2
9	+1	0	-2
10	+2	+1	+1
SUM	+14	+2	-5

On the basis of economic aspects (Chart 8), we can say that ecological farming accumulates the most negative externalities. The average value is at 3, 66. Economic aspects include meeting the standards and consumer demands, exploiting market possibilities, and the costs of entering the market. Based on such aspects, ecological technology accumulated the most negative externalities, since it has the highest administrative requirements and the highest costs required as well. The other two breeding methods didn't have notable advantages in this respect, because the costs and the regulatory elements won't allow too much space for the farmers to decide. From an ecological aspect, conventional technology accumulates the most positive externalities, since production can be more cost-efficient under intensive conditions. On the basis of average value, extensive breeding is the economically optimal solution, since it can help meet consumer demands. The need for supplementary forage is low, and the system of subsidies encourages this type of farming as well. Ecological breeding lags behind extensive, since the farmers need to meet several conditions for it; furthermore, it requires more administration, and not all varieties are suitable for this type of breeding. Quality procedure results in higher administrative loads, regulations on forage are compulsory for the farmers, thus it is more costly compared to the other two.

Summarizing all the aspects, we can state that extensive breeding creates the most positive externalities. Conventional breeding accumulates the most negative externalities.

Chart 9. Summarizing evaluation tables Source: self-made

Type of production	Conventional production	Extensive production	Ecological production	Market equilibrium value
Type of evaluation aspect				
Environmental aspect	-11	+11	+19	6.333
Technological aspect	-1	+3	+6	2.666
Ecologic aspect	+14	+2	-5	3.666
Summary of external effects (arithmetic average)	+3	+16	+20	13

After summarizing the data of the previous charts (Chart 9), we arrived at the conclusion that extensive farming creates the highest amount of externalities. Based on the research, conventional breeding causes higher environmental burden,

and has more negative externalities than the other two. The problem is that exaggerated externality content cannot be validated in the form of money on the market, since consumers intend to pay for it only to a certain extent. Accumulating too

many positive or negative externalities is therefore not desirable.

4. Conclusions

While comparing the results of the benchmarking analysis, we have come to the conclusion that extensive technology is the best from both environmental and economic aspects for the domestic meat-cattle sector. There is grassland in both sufficient quantity and quality in Hungary to allow extensive cattle fattening to expand further. This type of breeding is also preferred by the European Union, thus encouraging the activity with premiums related to extensive meat-cattle breeding. The agriculture's environmental footprint seems to have grown in past decades, as agriculture has become more and more industrialized. The cons of industrial agriculture are the damages caused by it, such as degradation of natural resources and biodiversity. After assessing the environmental aspects, the conclusion is that extensive breeding was the one that accumulated the fewest externalities, creating the fewest positive and negative impacts. However, positive externalities are fewer in the case of extensive technology compared to ecological, but compared to intensive farming systems, we can say it's more sustainable long-term. From the economic aspects, we can state that the most financial negative externalities occur under ecological conditions, since the fixed costs are higher due to the strict regulations. The distance from market equilibrium shows how sustainable the analyzed systems are. This distance is lowest for the extensive production system, which shows its sustainability, according to the three different key resources.

From an environmental aspect, the conventional, while from an economic aspect, the ecological farming aggregates the highest amount of externalities. The less adequate the equilibrium on the market is, the more externalities will be present. From the viewpoint of technological aspects, the system which is the best platform for innovation is the extensive production, with the least amount of externalities (value of 3). The distance from market equilibrium (Chart 10) clearly shows us the results of the multi-aspect benchmarking. According to the analysis, extensive farming can be called the most sustainable system operation, while conventional production generates the highest amounts of externalities (value of 10) in the resource system.

Chart 10. Distance from the market equilibrium
Source: self-made

Type of production	Conventional production	Extensive production	Ecological production
Distance from market equilibrium	10	3	7

The role of cost-efficient raw material production in the fattening industry is expected to become more prominent in the future, and the technology chosen will have a greater significance. Due to the extensive technology, costs may be saved, since it does not require costly assets, and the forage costs may also decrease due to grazing. In addition, when adhering to extensive and ecological farming, meeting the animal welfare and animal health standards does not cause difficulty for the farmers. By reasons of economic aspect, the framework of the agricultural production system in both the EU and Hungary has to be changed, due to the externality aggregations which can either be positive or negative. Without internalization of these external effects, we cannot balance our food production system in a sustainable way.

References

- [1] **Bithas, K. Sustainability and externalities:** Is the internalization of externalities a sufficient condition for sustainability? *Ecological Economics* 70, 2011.p 1703-1706
- [2] **Jeroen, van den Bergh** Externality or sustainability economics? *Ecological Economics* 69, 2010. p. 2047–2052.
- [3] **Camp, R. C. :** Üzleti folyamat benchmarking (Camp, R. C. 1995. *Business Process Benchmarking*. American Society for Quality.). Budapest, 1998, Műszaki Könyvkiadó. pp. 298.-309 (language: Hungarian)
- [4] **Evans, S. – Dale, B.G.:** „Benchmarking the engineer availability process: A case study", *Benchmarking: An International Journal*, (1), (1997) pp. 7 – 17
- [5] **Pálfalvi, J.** A benchmarking módszerről I., *A Tudás* 365 napja+1, [IX]. 2002.
<http://www.valtozovilag.hu/t365/tux0928.htm>
- [6] **Pigou, A. C.** *The Economics of Welfare*, Macmillian, Part II., London, 1920.
http://files.libertyfund.org/files/1410/Pigou_0316.pdf
- [7] **Marsalek, S.** Környezeti állapot, mezőgazdaság, fenntartható fejlődés (Environment, agriculture and sustainable development). *Gazdálkodás* [50] 2006. p. 12-27
- [8] **Farkas, F. M. - Fogarassy, C. – Szucs, I.** Allowance for external effects in efficiency calculations. In: Edited by Szucs. I. –Fekete. F. M. - *Efficiency in the agriculture (Theory in practice)* Agroinform Publisher, Budapest, 2008. p. 114-122
- [9] **Fogarassy, Cs.** Externalities in the agriculture - commodity and non-commodity outputs in the local food providing systems. *Development Prospect of Rural Areas Lagging behind in the CEE Region, Visegrad Founders' Conference*, 24-27 May, 2011. Gödöllő.
- [10] **Nyiri, L.** *Földműveléstan (Soil cultivation)*. Mezőgazda Kiadó, Budapest, 1993. p. 45-60
- [11] **Bakosné, B. M.:** Economic analysis and environmental assessment of cattle breeding, In: *Economics and sustainable agriculture*, Gödöllő, 2011, pp. 152-173

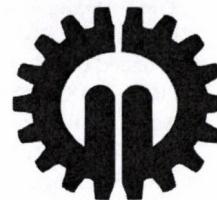

POSSIBILITY OF DENDROMASS PRODUCTION ON WOODY ENERGY PLANTATIONS

Author(s):

A. Vágvolgyi – M. Dancs – I. Czupy

Affiliation:

University of West –Hungary, Faculty of Forestry, Institute of Forest- and Environmental Techniques,
H-9400 Sopron, Ady E. st. 5.,

Email address:

avagvolgyi@emk.nyime.hu, dancs@mnsk.nyime.hu, iczupy@emk.nyime.hu

Abstract

Much more renewable energy utilized green economy need to build in Hungary, this way avoid for economic dependence. Biomass as a “green energy” could be to the long-term solution. The majority of the biomass is wood-based (i.e. dendromass). One alternative the producing large quantities of wood in short time are the woody energy plantations. We examined in our research past and present situation of woody energy plantations. Energy plantations examination look back more decade, but their area is not significant yet. The biggest area is produce poplars including AF2 and Monviso clones. The results of examinations have proven that with stump diameters between 8-112 mm or 2 90 mm diameters at breast height the tree mass can be estimated, thus the plantation yield can be determined. So can we value the plantation yield without cutting the trees. We examined the relation between the plantations and markets. We established that the dendromass quantity from the plantations is only minimally sufficient to needs of power stations. Finally we analysed that problems which influence the plantations yield and survival.

Keywords

dendromass, energy plantations, tree mass estimation, yield of the plantations

1. Introduction

The annual energy consumption of Hungary is estimated 1000-1100 PJ [6]. With domestic energy production decreasing continuously our dependence on import has been increasing steadily. It would be wiser to build our future on a green economy basing on local renewable resources instead of depending on import-based and incalculable energies.

Our country renewable energy potential would enables that we could meet almost the half of our energy demand. In view of the country ability our possibility long distance is the „green energy”. Not only has biomass a significant role in energetics but is an important factor to rural and agricultural development too.

The majority of this biomass is wood-based [1,5]. One of the possibility the fast and large biomass production is energy plantation.

2. Situation of energy plantation in our country

Energy plantations examination look back more decade equally in abroad and our country. Before 2005 had been energy plantations examinations on 50-60 ha. If we had started the energy plantations deployment in 2005-2006 on 5-10000 ha the energy plantation area should grown 60000 ha by 2010. 1 million t/year biomass were produced on this area. (counting 16 t/ha/year) [9].

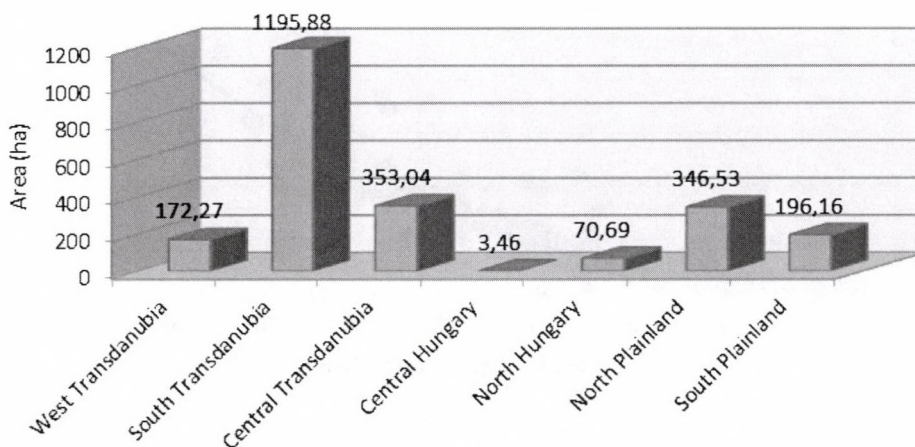

Figure 1. Area of woody energy plantations in Hungarian regions [8]

The first data of energy plantations area we traceable in 2009: 1505 ha [4]. By data of Forest management NÉBIH the announced energy plantations area are in year 2012 2080 ha [7], in 2013: 2338 ha [8].

Analysed the area distrain we can see (Fig. 1.) that the region "South Transdanubia" is prominent, where is found important outlet. (Pannonpower group).

Energy plantations should be installed in a location where the markets are available.

Three species territorial control are significant in our country: poplar, willow, and locust. This species deployment authorized

by relevant law. The poplar species have got the most significant area (69%), followed by willows (26%) and standing of the line the locust (5%) (details tab year 2013).

Two Italian varieties territorial control are significant out of poplars: AF2 clone 869 ha and Monviso clone 522 ha. In one respect these varieties adulterant stand by the market and the other hand the yield these clones are greater 10% than the remaining clones. We examined the deployment year of energy plantations (Fig. 2.). Mostly in year 2008 grew the energy plantation area then in year 2012 were a recent deployment wave.

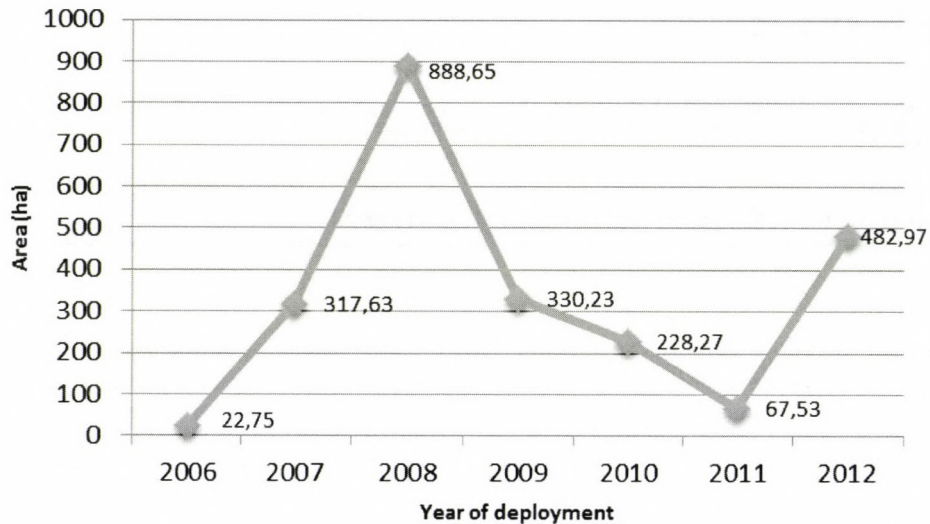

Figure 2. Woody energy plantations deployment yearly 2006-2012 [ha] [8]

3. Yield estimation on woody energy plantation

Because of the lack of yield estimation functions in Hungary, and in order to develop a tool to predict yield we made a suite of own measurements in 36 separate plantations by 19 settlements. Our aim was to collect data for various site conditions. Yield measurements were carried out in each case outside the vegetation period, in AF2, AF6, Monviso, Kopecky, Pannonia, I214 poplar plantations 1-7 years of age. Predominantly AF2, Kopecky and Monviso plantations were surveyed. Measured were

10 m long sections with three replicates for each plot respectively. Taking in account shoot and row space, we measured the diameter at soil surface and breast height (1.3 m) level with mm accuracy, afterwards felling trees on 3x10 m sections and weighing them with an accuracy of 10 g for each.

After ordering data along age and clone type we produced yield graphs. Our measurements were carried out for a range of 8-112 mm diameter at soil surface and 2-90 mm breast height diameter, and they resulted in high correlation yield estimation functions (Fig. 3., 4.). [2, 3].

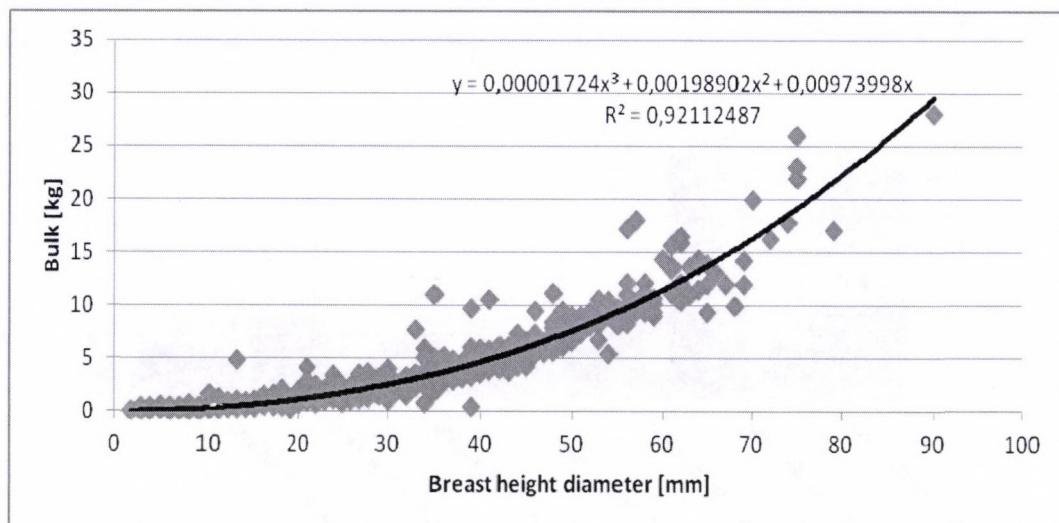

Figure 3. Estimated bulk weight as a function of shoot diameter 1,3 m above ground [3]

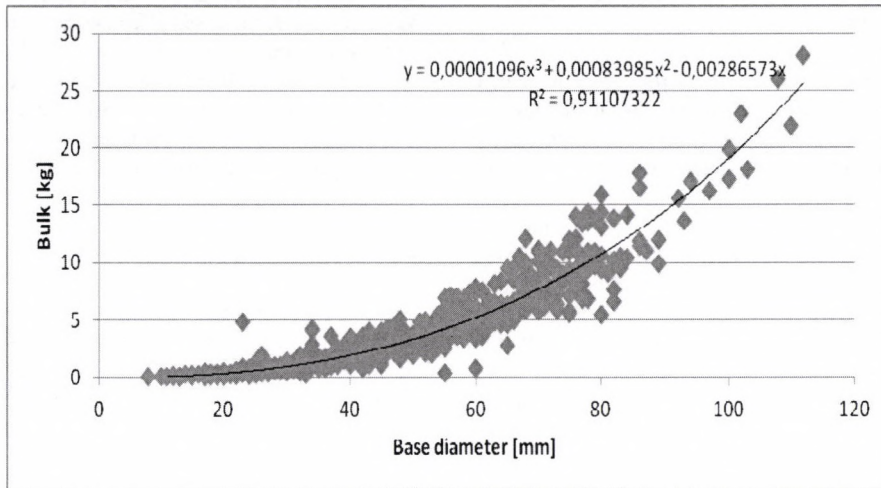

Figure 4. Estimated bulk weight as a function of soil surface level (base) shoot diameter [3]

Chart 1. Comparison of yield estimation results with measured biomass from harvesting in a Kopecky poplar clone plantation by Kiskunlacháza [3]

	1 [t/ha/2year]	2 [t/ha/2year]	3 [t/ha/2year]	4 [t/ha/2year]	5 [t/ha/2year]	6 [t/ha/2year]	7 [t/ha/2year]
	19,03	20,52	18,7	20,02	22,08	19,7	19,6
difference to measurement	-3%	+4%	-5%	+2%	+12%	-0,5%	-

Key to signs: 1 – Yield with base diameter by „Kiskunlacháza” diagram, 2 – Yield with breast height diameter by „Kiskunlacháza” diagram, 3 – Yield with base diameter by „Kopecky” diagram, 4 – Yield with breast height diameter by „Kopecky” diagram, 5 – Yield with base diameter by „global” diagram 6 – Yield with breast height diameter by „global” diagram, 7 – Measure yield after harvesting

Results of the yield estimation method were compared with the total biomass measured after harvesting a 2 years old Kopecky poplar plantation (Chart 1.).

Chart 1 clearly indicates, that there is no significant difference between the estimates and the measured data (maximum deviation 12%), so it was stated that all our yield estimation functions can be used to predict the amount of dendromass.

In case of the plantations of this measurement, with an age ranging from 1-7 years (later already after 3 harvesting), yield estimation functions predict 2 t/ha to 50 lutro-t/ha yearly biomass production (6.600 shoots/ha, 90% planting success).

is characterized by decentralization, which is running in a smaller scale, at multiple sites, closer to the end-users. As nowadays the decentralized energy production has only a small proportion in Hungary, biomass has often to be transported to big (30 MW) power plants, the profitability of the plantations is limited.

We examined the location of power plants and plantations creating a matrix, from which the different input-output of them can be determined.

We can ascertainable that biomass demand of active power plants in Hungary are (Fig. 5.) 1.500.000t/year, on the woody energy plantation produced biomass satisfy of this 1,3%.

4. Location matrix of energy power plant and woody energy plantation

Conventional power generation in our country is still largely under central control, the innovative (electrical) power generation

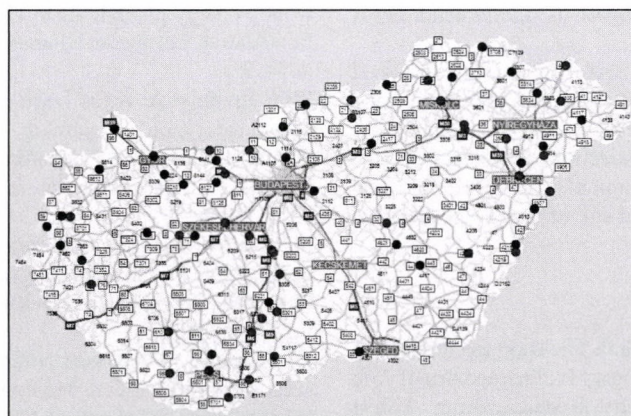

Figure 5. Biomass power plants in Hungary (blue dots=running; red dots=planned) [3]

5. Technologies, difficulties, reasons and consequences in woody energy plantations

The laws gives a large control above the woody energy plantations. It is important to simplify or discontinue the laws.

Based on the experiences in Hungary, the economic efficiency of woody energy plantations largely depends on the attitude of the farmers.

The law doesn't make obligatory the preliminary site. Therefore many case was not the right species/clones for the specific site so we can find several plantations with low productivity or even total failure and the area was ploughed.

Weed control has a crucial role in plantations in Hungary. On sites with limited water supply of the plants, strong weed concurrence can effect tree growth dramatically in a negative sense, even leading to total failure of planting.

In Hungarian energy plantations there is no irrigation, and fertilization activity is low. Rust is the most important disease

caused by various fungi of the *Melampsora* spp., and energy plantation is in some cases effected by the red poplar leaf beetle (*Chrysomela populi* L.), while pest control is virtually unknown to private farmers. Significant damage occurs only in the first year, from the second growing season stocks are not appreciably effected unless yield is partly decreasing.

In Hungary the significant number of wild game is important for woody energy plantations, red deer and roe deer can cause the highest damage to them. In some registered cases game damage made up to 100%. Fencing can extremely increase the cost of establishment. [2]

Further problems can arise in terms of harvesting, as indeed only few proper machines are available. In the future expected additional investigation and machinery technology adaptation which we can take care of the harvesting optimal and economically. Difficulties, reasons and consequences in energy plantation are summarized in Fig. 6.

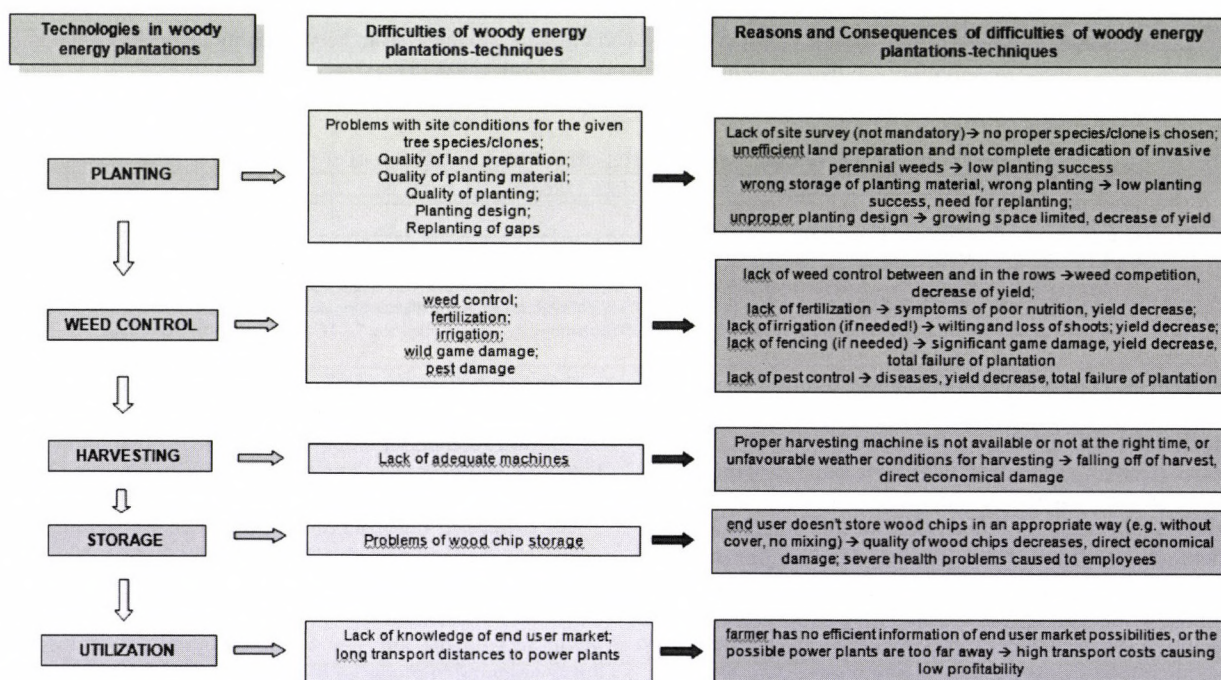

Figure 6. Technologies, difficulties, reasons and consequences in energy plantation [3]

6. Conclusion

We can establish the result of research that increase of woody energy plantations area would be needed in coming years in our country. So can the wood energy plantations signify dendromass base for energy plants.

Area increase promote a deliberate economic and legal regulation besides would be needed the supporting incentive and the continuation of the results home machinery development.

Knowledge with woody energy plantation of farmers would be needed increase so they can eliminate the problems and deficiency and extend the yield and age of energy plantations, improve the sanitary status.

References

[1] Czupy I., Vágvolgyi A., Horváth B. The Biomass Production and its Technical Backgorund in Hungary In: Proceedings of 45th International Symposium on Forestry Mechanization: "Forest Engineering: Concern, Knowledge and Accountability in Today's

Environment". Dubrovnik; Cavtat, Horvátország, 2012. 10.08-10.12. Zagreb: University of Zagreb. pp. 1-9. ISBN:978-953-292-025-3.

[2] Vágvolgyi A., Heil B., Kovács G. Development trends of woody energy plantations in Hungary. Tudományos közlemény In: Central European Biomass Conference Proceedings CD. 2014, 8 p.

[3] Vágvolgyi A. A fás szárú energetikai ültetvények helyzete Magyarországon napjainkig, üzemeltetésük, hasznosításuk alternatívái". Nyugat-magyarországi Egyetem, Erdőmérnöki kar, Kitaibel Pál környezettudományi doktori iskola PhD dolgozat. 2013.,195 p.

[4] Szajkó G. et al. Erdészeti és ültetvény eredetű fás szárú energetikai biomassa Magyarországon. Műhelytanulmány, Regionális Energiagazdasági Kutatóközpont, Budapesti Corvinus Egyetem, 2009.

[5] Gógös Z. Biomassa potenciál és hasznosítása Magyarországon. In: Agrárágazat, Mezőgazdasági havilap, 2005 augusztus.

[6] Központi Statisztikai Hivatal (KSH) adatbázisa, 2013. www.ksh.hu

[7] **Kopányi I.** Energetikai ültetvény adatok.
KopanyiI@nebih.gov.hu, 2012. [E-mail] Message to Vágvölgyi
Andrea (avagvolgyi@emk.nyme.hu). Küldés: 2012. július 11.(Sz)
10:24

[8] Energetikai fásszárú ültetvények Magyarországon 2013
https://www.nebih.gov.hu/szakteruletek/szakteruletek/erdeszeti_i_gazgatosag/kozerdeku_adatok/adatok/ada_tok.html

[9] **Giber J., Gerse K., Tringer Á.** A magyar energiapolitikai
tézisei a 2006-2030 közötti időszakra 12. fejezet. A megújuló
energiaforrások szerepe az energiaellátásban. Gazdasági és
Közlekedési Minisztérium, 2005.



APPLICATION OF NUMERICAL ANALYSIS FOR THE DESIGN OF ROTATING TOOLS

Author(s):

T. Major¹ – V.Csanády²

Affiliation:

¹University of West –Hungary, Faculty of Forestry, Institute of Forest- and Environmental Techniques
H-9400 Sopron, Ady E. st. 5.,

²University of West –Hungary, Faculty of Forestry, Institute of Mathematics, H-9400 Sopron, Ady E. st. 5.,

Email address:

major@emk.nyme.hu, vcsanady@emk.nyme.hu

Abstract

By modelling the interaction of the tool and the soil, development time and costs can be significantly reduced. Since the operation of the rotating tool involves large forces and displacements, traditional finite element methods cannot be applied. Instead, we turned to a combined FEM/SPH simulation. Using the combined FEM/SPH simulation, the horizontal force acting upon the rotating tool as a function of time was determined at 1 km/h and 1.5 km/h forward speeds. By fitting a function to the results of the simulation, the value of the average and maximum horizontal forces was obtained. For setting up the geometry, first we created the model of the soil surrounding the tool using the DesignModeler module of the Ansys software

Keywords

soil tiller, soil and the soil-tool interaction, Solid Edge software, Ansys software

1. Introduction

The soil tiller equipment investigated has a rotating tiller with four knives, the knives having an arc ($R=340$ mm) and three pairs of wings having decreasing widths towards the free end (55 mm, 45 mm and 35 mm). The placement of the wings is perpendicular to the arc of the knives, and the knives bend back with regards to the direction of the rotation. The edges of the knives and the wings are sharpened to 50° to ease their penetration into the soil. We created a geometrical model of the rotating tool (Figure 1) using Solid Edge software and used Ansys 13 finite element program for the numerical analysis.

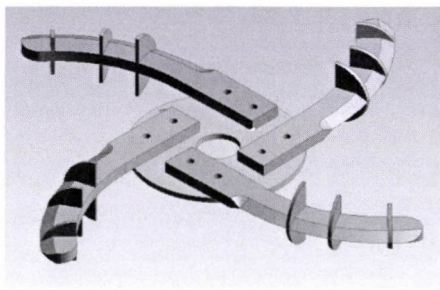

Figure 1. Geometrical model of the rotating tool

2. Material and method

For setting up the geometry, first we created the model of the soil surrounding the tool using the DesignModeler module of the Ansys software. The surface of the soil was set at 200 mm from the axis of the tool, thus, given the size of the tiller, the working depth was 220 mm. We created a 1100 mm long, 600 mm wide and 350 mm deep soil trough around the tool (Figure 2).

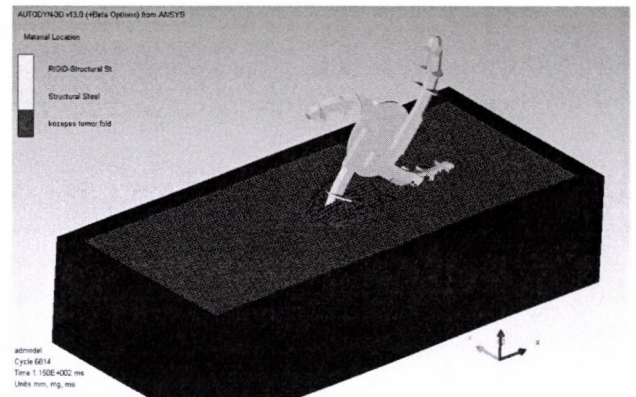

Figure 2. The rotating tool and the soil trough

We did some simplification on the geometrical model to improve the mesh, that is, we removed the screw holes and the axle hole.

During the modelling tetrahedral elements were used for the mesh of the tool.

We considered the tiller a solid body and used Drucker-Prager model (Bojtár, 1988) for the description of the mechanical properties of the soil. The Drucker-Prager model is a modification of the Mohr-Coulomb mechanical model. The D-P has a cone shape in the principal stress field (Figure 3) and therefore this shape does not introduce numerical problems on the plasticity surface.

The basic data for the mechanical model (medium soil compactness) come from measurements carried out at the Geotechnical Department of the Faculty of Civil Engineering of the Budapest University of Technology and Economics (Mouazen - Neményi - Horváth, 1998), since no such investigation has been conducted for forest soils.

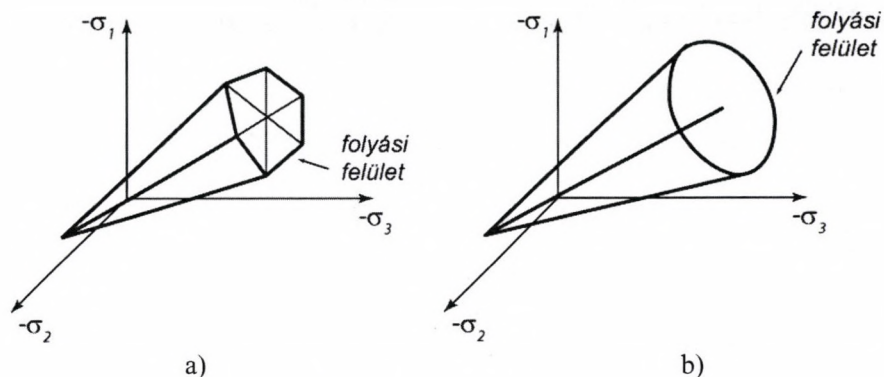

Figure 3. Yield criterion for 3D stress state
(a) Mohr-Coulomb model; (b) Drucker-Prager model

Chart 1. Properties of the soil and the soil-tool interaction

Property	Value
<i>Soil properties:</i>	
- cohesion [kPa]:	15,5
- inner friction angle [deg]:	31,8
- density [kg/m ³]:	1731
- Poisson's ratio:	0,3596
- Young's modulus [kPa]:	8067
<i>Properties of the soil-tool interaction:</i>	
- friction angle between soil and metal [deg]:	23
- adhesion between soil and metal [kPa]:	0

The operation of the rotating tool (simultaneous linear and rotational motions) is a transient phenomenon, during which large forces or displacements can occur. The finite element method (FEM) is suitable only for small forces and displacements, because for large displacements, the continuity of the finite element mesh is broken and the simulation sticks. A traditional FEM is practically incapable of modelling material discontinuities, therefore we used a combined FEM-SPH simulation for modelling the interaction between the soil and the tool. The tool was built up from traditional finite elements and the soil from SPH elements. SPH (Smooth Particle Hydrodynamics), unlike FEM, is a completely mesh-independent numerical method (Gingold - Monaghan, 1977; Monaghan, 1988; Monaghan, 1992), originally applied for astronomical calculations and later for modelling fluid mechanics. Recently, it has been successfully used for modelling landslides (Bui H. H. et. al., 2008).

SPH elements can be thought of as independent particles with certain properties (e.g. mass, density etc.) whose position and speed is known for any moment in time. They are not tied to a node, they can experience any amount of displacement. A radius is given for each particle, such that the algorithm considers every other particle within a distance twice that radius a neighbour. The physical properties of a particle are calculated from the properties of its neighbours using a special weight function that we choose. A great advantage of SPH simulations is that bodies can undergo substantial deformations, splinter, mix up with each other, without practically hindering the calculation.

We chose 14 mm for the size of the SPH elements. The number of SPH elements in the calculation was 147885 and the elements in the FEM mesh was 34446.

Constraints were used to stop the tool from sinking or slewing.

3. Results and conclusion

Running the simulation at 1 km/h and 1.5 km/h forward speed and 58 RPM yielded a horizontal reaction force acting upon the tool, shown on Figure 4. In spite of the noise, a sinusoid function can be observed. The reason for this is that the part of the tool immersed in the ground is changing continuously.

Part Summary (Ident 0 - admodel)

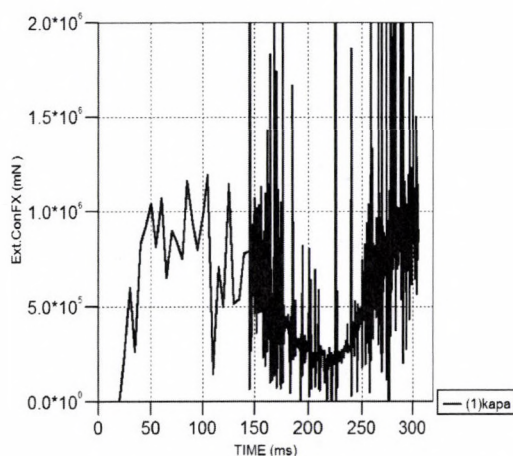

Figure 4. Traction force as a function of time, at 1 km/h forward speed

In order to determine the average and maximum tractive force, we fitted a sinusoid function on the data points using the software STATISTICA, and carried out a correlation analysis.

$$\text{var2} = b_3 \cdot \sin(b_2 \cdot (\text{var1} - b_1)) + b_0$$

where:

var2: horizontal reaction force [mN],

var1: time [ms].

b₀, b₁, b₂, b₃ are coefficients of the function with values shown in chart 2.

Chart 2. Coefficients of the function and its correlation coefficient

Forward speed [km/h]	<i>b₀</i>	<i>b₁</i>	<i>b₂</i>	<i>b₃</i>	<i>R</i>
1	322478	0,030228	366,4032	559621,3	0,76605
1,5	355581	0,033438	237,8738	635920,9	0,67366

By refining the data, the value of the correlation coefficient can be improved (to R=0,89344) but the shape of the function remains substantially the same.

The coefficients of the function lead to an average tractive force of 560 N and maximal tractive force of 882 N at 1 km/h; and an

average tractive force of 636 N and maximal tractive force of 992 N at 1.5 km/h.

The fitted functions and the data points are shown on Figures 5 and 6.

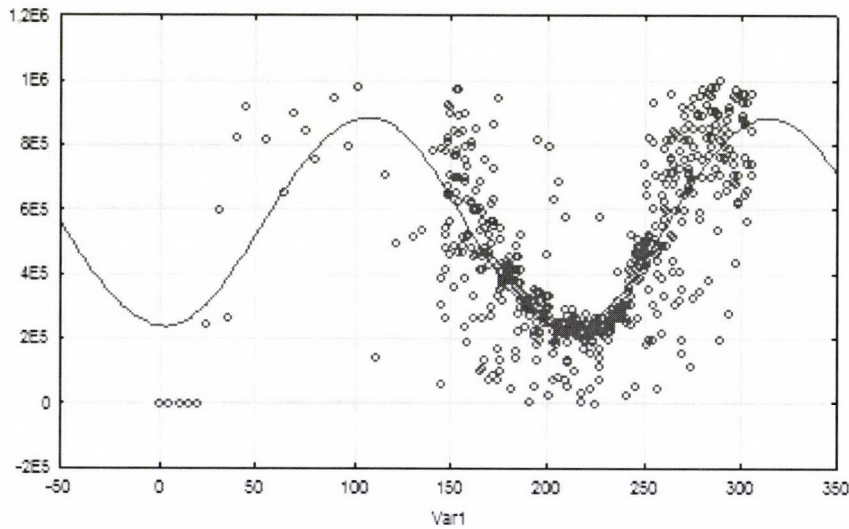

Figure 5. Fitted function at 1 km/h tractor speed

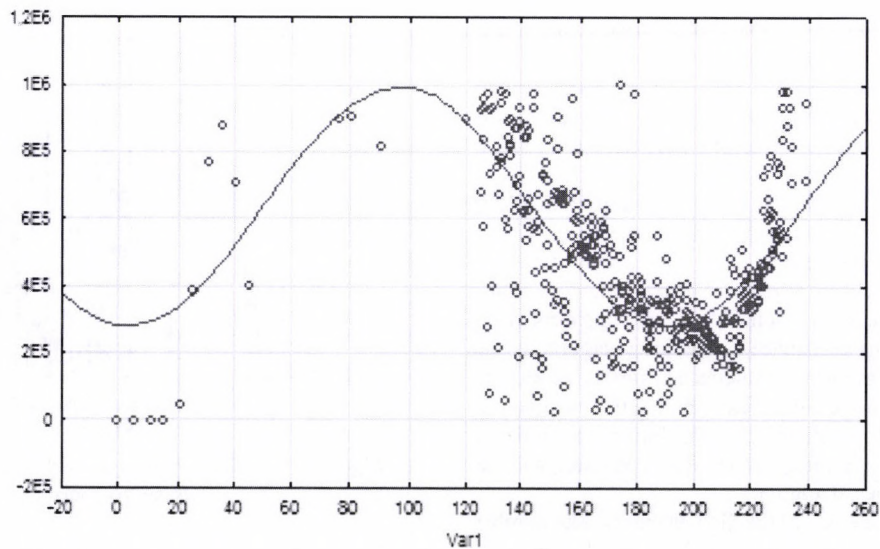

Figure 5. Fitted function at 1 km/h tractor speed

4. Summary

Earlier equipment, including cultivation tools, were designed by relying on practical experience, largely without theoretical investigation. The investigation and modelling of tools is nowadays an important part of the development process of new agricultural equipment. The precise mechanical sizing of a new tool must be carried out through field tests and modern mathematical-mechanical methods (finite element method). By modelling the interaction of the tool and the soil, development time and costs can be significantly reduced.

Since the operation of the rotating tool involves large forces and displacements, traditional finite element methods cannot be applied. Instead, we turned to a combined FEM/SPH simulation. Using the combined FEM/SPH simulation, the horizontal force acting upon the rotating tool as a function of time was determined at 1 km/h and 1.5 km/h forward speeds. By fitting a function to the results of the simulation, the value of the average and maximum horizontal forces was obtained.

References

- [1] **Bojtár I.** (1988): Mechanikai anyagmodellek. Tankönyvkiadó, Budapest.
- [2] **Bui H. H. – Fukagawa R. – Sako K. – Wells J. C.** (2008): SPH-Based Numerical Simulations for Large Deformation of Geomaterial Considering Soil-Structure Interaction. The 12th International Conference of International Association for Computer Methods and Advances in Geomechanics (IACMAG), 1:570-578.
- [3] **Gingold R. A. – Monaghan J. J.** (1977): Smoothed Particle Hydrodynamics: theory and application to non-spherical stars. Mon. Not. R. astr. Soc. 181:375-389.
- [4] **Monaghan J. J.** (1988): An introduction to SPH. Computer Physics Communications. 48:89-96.
- [5] **Monaghan J. J.** (1992): Smoothed Particle Hydrodynamics. Annu. Rev. Astron. Astrophys. 30:543-574.
- [6] **Mouazen A. M. – Neményi M. – Horváth B.** (1998): Investigation of Forestry deep subsoiling by the finite element method. Hungarian Agricultural Engineering. 11:47-49.



EXAMINING THE VELOCITY- AND TIME-DEPENDENT FRICTION IN CASE OF STEEL AND POLYAMIDE

Author(s):

A. Csatár¹ – F. Safranyik²

Affiliation:

¹Scientific Deputy General Director, Hungarian Institute of Agricultural Engineering

²Szent István University, Faculty of Mechanical Engineering, Department of Mechanics and Technical Drawing

Email address:

csatar.attila@gek.szie.hu, [safranyik.ferenc@hallgato.szie.hu](mailto:sufranyik.ferenc@hallgato.szie.hu)

Abstract

The phenomenon of friction reduces the efficiency of almost all machines in practice. For reduce the deficits we have to understand this phenomenon and we have to take it in all cases into consideration during design. Nevertheless in certain cases the describing of a friction process is very difficult; because this depends on a lot of parameters. In case of polymers, granular materials or in geology the rate- and state dependent friction have great importance. In this paper velocity- and time dependent friction of polyamide and steel is examined with the help of a direct shear apparatus, which was developed in our earlier work. Based on the results of experimental measurements the previously developed apparatus is suitable for examine time dependent properties of friction.

Keywords

friction, time-dependence, velocity-dependence

1. Introduction

The friction process was examined first almost three centuries ago by Coulomb [5] and it was discovered that the kinetic friction does not depend on the shear velocity. Later with more precise experiments showed that this phenomenon depends on a lot of parameters, such as materials, roughness, temperature or the shear velocity. Due to the diverse parameters the description of a friction process is very difficult in certain cases. In geology, mining- and earthquake science, in case of polymers, granular materials or other special materials the time- and velocity-dependent friction (creep and relaxation) have great importance and only few researchers investigate the thermodynamic aspects of this time dependence of friction [6, 7, 8]. The aim of our work is to examine the velocity dependent friction of polyamide and steel and the revise of the previously by our developed direct shear testing apparatus.

1.1 Friction test

The knowledge on the shear strength is very important in description of a friction process. This parameter means the relationship between the displacement and the shear force and a lot of parameters have influence on this [1]. The shear strength

can be evaluated by using direct shear test; in course of this the surfaces are pressed together with constant normal load meanwhile moving on each other. During the shear process, the shear force is measured as function of displacement. The material properties, the roughness and the shear velocity have great influence on shear strength [1].

During the direct shear test of two smooth surfaces (under constant normal load and constant shear velocity) the shear strength increases to an initial peak, which is followed by slowly displacement weakening and then stabilization at a residual shear strength, which does not change or increases very slowly with additional displacement [1].

Based on shear tests with different normal loads, the shear strength is in linear correlation with normal strength. The slope of this line is the friction coefficient concerning to the materials, the designate constant of this line is the cohesion between the surfaces. The shear strength is based on the Mohr-Coulomb equation [5]:

$$\tau(\phi) = c + \sigma_n \cdot \tan \phi, \quad 1$$

where c is the cohesion, ϕ is the friction angle between the surfaces.

The residual strength is [5]:

$$\tau(\phi) = \sigma_n \cdot \tan \phi_r, \quad 2$$

where ϕ_r is the residual friction angle between the surfaces.

1.2 Time- and velocity-dependent experiments

The time- and velocity-dependent friction have great importance in geology: faults may undergo decelerating postseismic slip (afterslip), long term stable slip (fault creep) in the absence of earthquake instability, and perhaps slow postseismic slip [2]. For this reason Dietrich et al. made laboratory shear experiments with clean surfaces of granite [3, 4] and with a layer of simulated fault gouge consisting of crushed and sieved granite [2]. These experiments were made with different shear parameters (normal load, shear velocity). The sample assembly consists of a three blocks, sandwich type direct shear configuration (Fig. 1.).

Three different types of tests were made: constant velocity, multiple velocity and time dependence shear tests. The constant velocity tests were made at 2.5 $\mu\text{m/s}$ (Fig. 2/a). In the multiply-

velocity tests the shear velocity was constant for a predetermined displacement, then suddenly changed by a factor of 10, held constant for another displacement then changed again and so on (Fig. 2/b). The third group of shear test was the time-dependence tests, in which constant velocity shear was interrupted at a specified displacement where the control displacement is held at zero for a specified time interval (Fig. 2/c) [2].

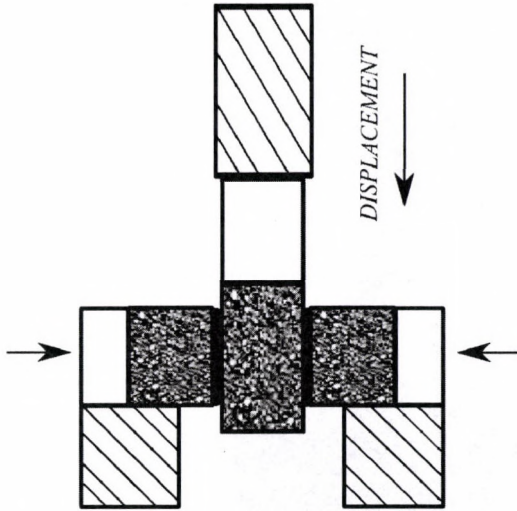

Figure 1. The sample assembly by Dietrich [2]

The aim of the constant velocity tests were to examine the overall form of stress-displacement curves (Fig. 2/d) to permit reasonably direct comparison to be made for the control of strength by the fault parameters. Based on these curves the shear strength increases to an initial peak, which is followed by a slow displacement weakening and then stabilization at residual shear strength (Fig. 2/d). If the shear stress cycling to zero after reaching residual strength, acts to restore the peak in the stress-displacement curves. This cycling increases the total displacement and also the peak and residual strength [2].

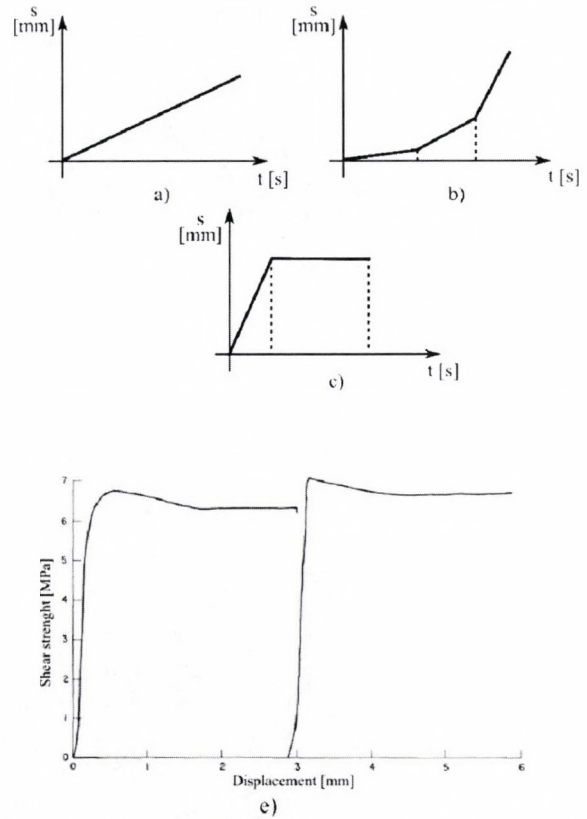

Figure 2. a) Constant velocity test; b) Multiply velocity-test; c) Time dependence test; d) Shear diagram with constant velocity and normal stress [2]

The purpose of the multiply-velocity tests was to look for variations of strength as a function of velocity. A step increase of shear velocity results an immediate jump in frictional coefficient followed by displacement dependent decay and stabilization at a new steady-state friction. The reverse is seen if the shear speed is decreased (Fig. 3.) [3].

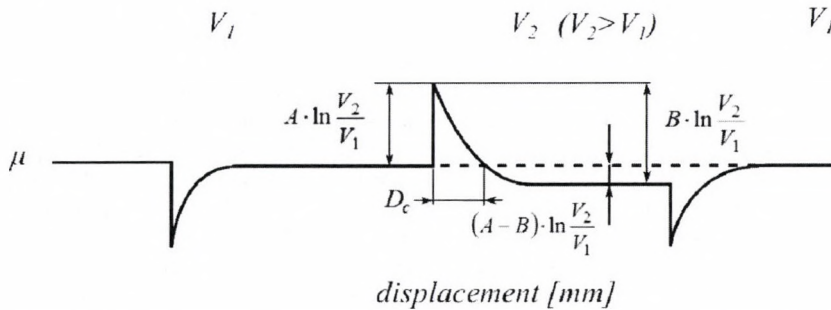

Figure 3. Effect of steps in shear speed on a friction coefficient, the case of velocity weakening [3]

Dietrich and Kilgore [3] made a shear rate- and state-dependent constitutive formulation for fault tests. This formulation provides a descriptive framework for the interpretation of the transient shearing phenomenon. The coefficient of friction can be represented [3]:

$$\mu = \frac{\tau}{\sigma} = \mu_0 + A \cdot \ln\left(\frac{V}{V^*} + 1\right) + B \cdot \ln\left(\frac{\Theta}{\Theta^*} + 1\right) \quad 3$$

where τ and σ are shear and normal stress V is a shear speed and Θ is a state variable. Parameters μ_0 , A and B are experimentally determined constants and V^* and Θ^* are normalizing constants [3].

1.3 The developed shear testing apparatus

The design of our test apparatus was made on the basis of Dietrich's vertical shear tester [2]. In case of Dietrich's arrangement the displacement was vertical and the normal force was horizontal, while in our case the normal force is provided by an INSTRON 5581 type universal material testing machine, so it should be vertical thus the displacement must be horizontal. The shear force was measured by a load cell which is at the holding point of the fixed part; the displacement was measured by an inductive displacement transducer at the moving part. The displacement provided by a stepper motor (Fig. 4.).

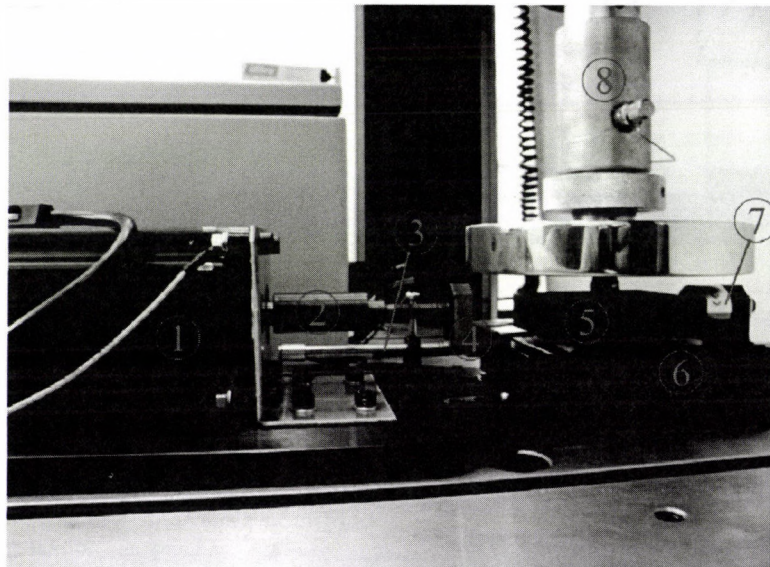
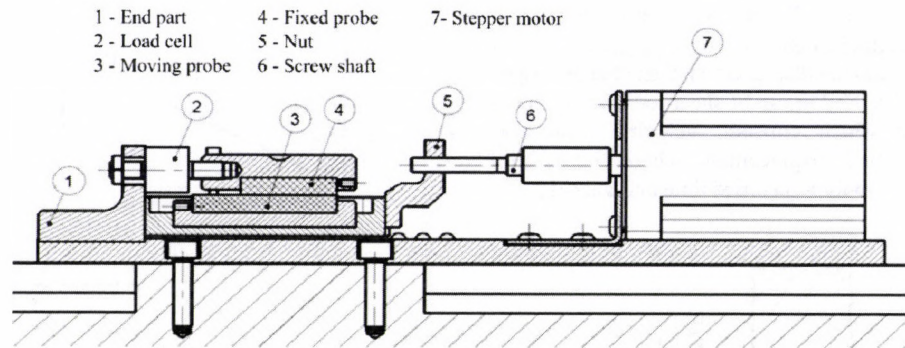

Figure 4. The test assembly and the finished apparatus

On Fig. 4 the finished shear apparatus can be seen: 1 – stepper motor; 2 – screw shaft and cased coupling; 3 – displacement transducer; 4 – nut; 5 – fixed part; 6 – moving part; 7 – load cell; 8 – INSTRON 5581. The normal load was provided by the INSTRON 5581 type universal material testing machine the load was transferred through a steel ball that ensures the punctual load to the fixed part.

The chosen motor is a three phase stepper motor that divides a full rotation into a number of equal steps; therefore in order to achieve the minimum speed a XINJE DP-7022 digital stepper drive was used. With its microstep function no more than 65535 step/rotation can be set up which ensures the low and exact angular velocity of the stepper motor. Microstepping is a way of moving a stepper smoothly. The measurement system of the appliance is a separate module. The displacement is measured by an HBM WETA 1/10 inductive economic displacement transducer, the shear force by an HBM U9B 5 kN force transducer. The Spider 8 and the Catman 4.5 software carry out the data acquisition. [9]

2. Experimental measurements and results

Experimental measurements were carried out with polyamide and steel probes. The usual experimental protocol for evaluating slip rate and state dependence of friction of changing the shear velocity in a stepwise manner under of constant normal stress. Normal stress was held constant during the measurements which were ensured by the force regulated INSTRON 5581 universal material testing machine. Multiple velocity tests were carried out with constant shear velocity for a predetermined displacement,

then suddenly changed by a factor of 10, then held constant for another displacement and changed back to the first velocity. The tests were carried out with two different speed levels, 2 and 4 $\mu\text{m/s}$, for both materials. Additionally two different normal stress levels were investigated, 20 and 40 kPa. During the tests the shear force and the displacement were measured and the shear diagrams were determined (Fig. 5.).

The purpose of these multiple-velocity tests was to look the time dependent friction coefficient as seen in the earlier rock friction experiments of Dietrich [2, 4, 6]. In these earlier works two different velocity effects was observed, the step increase of shear velocity results in an immediate jump in frictional coefficient followed by displacement dependent decay and stabilization at a new steady-state friction. The reverse is seen if the shear speed is decreased. This friction coefficient jump on the higher speed level and the decrease on lower speed level can be seen on the shear diagrams (Fig. 5.).

Step changes of velocity results residual and transient changes in friction coefficient. Firstly at constant sliding velocity has proceeded for a sufficient distance for μ to have stabilized at a residual value (μ_1) then due to the suddenly increase of velocity produces an immediate increase in friction coefficient then this followed by a decrease (μ_2) to a new residual value. This new residual value is generally less than the residual coefficient on the previous slower velocity phase. After predetermined sliding displacement the shear velocity abruptly decrease to the previously lower level results a positive jump in the friction coefficient to a new residual value (μ_3), which is greater than the residual coefficient at the first phase of the test with the same sliding velocity.

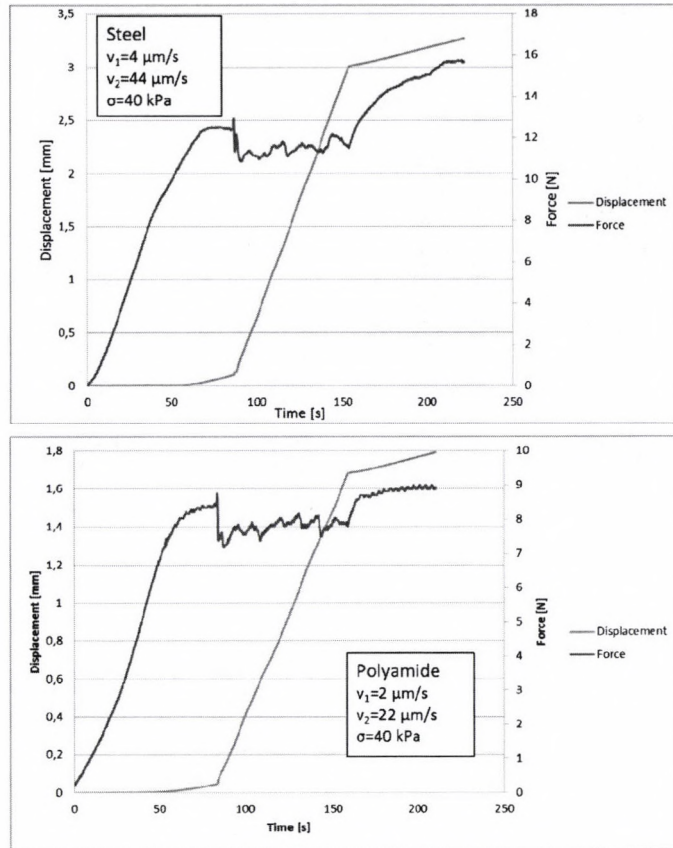

Figure 5. Displacement in function of time

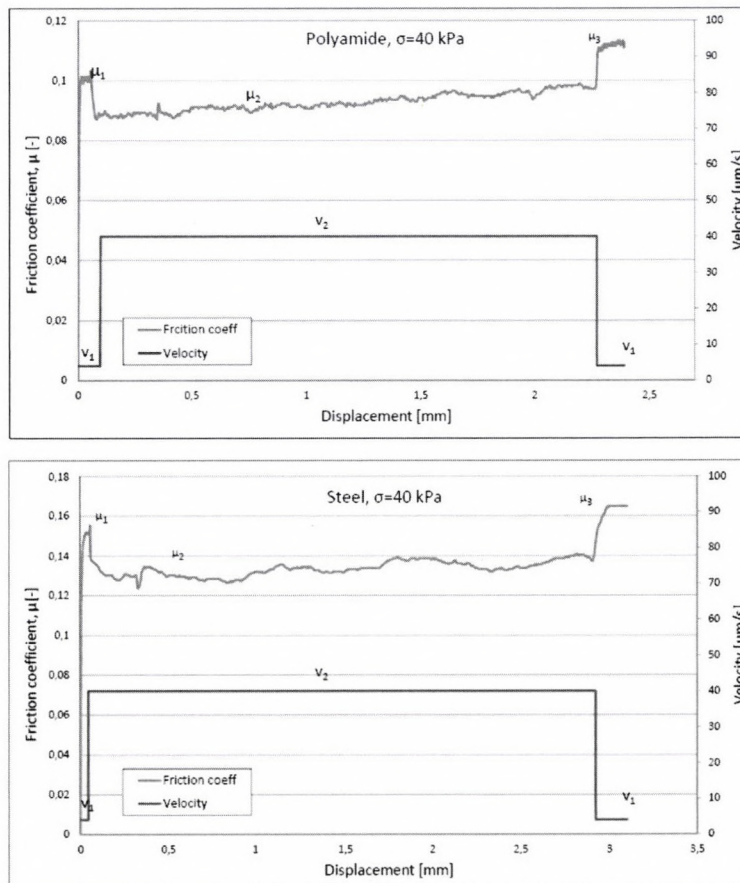

Figure 6. Friction coefficient versus displacement

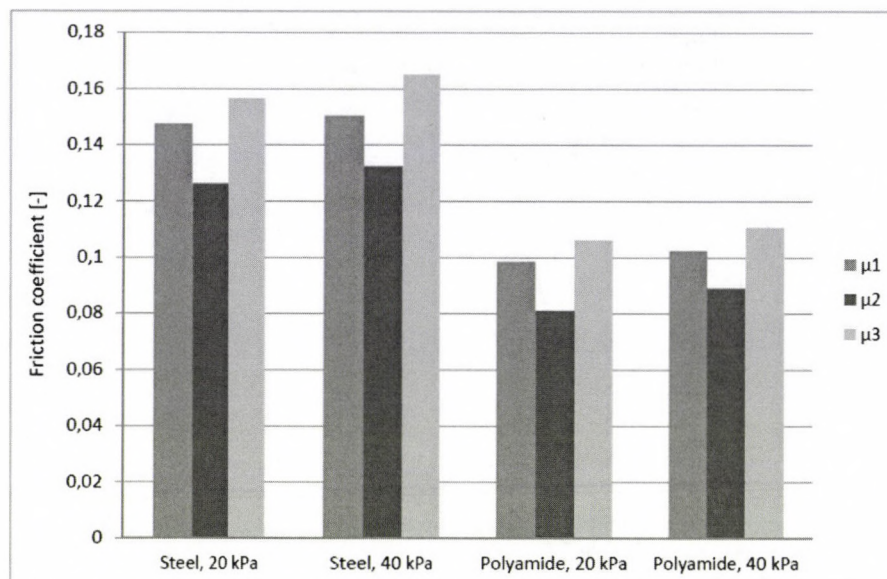

Figure 7. The changes of residual strengths in case of different normal stress

Based on the different measurements determinable that the μ_1 , μ_2 , μ_3 values depend on the normal stress and the material. In case of rigid materials (steel) the residual friction coefficient decrease and increase are greater than a less rigid material (polyamide). Based on these observation verifiable that our shear apparatus (which based on Dietrich's work) is suitable for examine the time- and velocity-dependence of friction.

3. Summary

We have developed a simple experimental device for testing time- and velocity dependent properties of friction. The first measurements were performed with poliamid and steel. They show velocity weakening and stick-slip phenomena at the higher velocity level for both materials. Therefore we have demonstrated, that the apparatus is able to reproduce several important time dependent friction phenomena and therefore it is suitable for experimental investigations. We have also investigated effects related to shear strength.

4. Acknowledgment

This paper was supported by the János Bolyai Research Scholarship of the Hungarian Academy of Sciences.

References

[1] Asszonyi, Cs., Kertész, P., Richter, R.: A kőzetmechanika anyagszerkezeti és reológiai alapjai, Veszprémi Akadémiai Bizottság, Veszprém, 1980, pp. 446.

[2] Dietrich, J. H.: Constitutive properties of faults with simulated gouge, Geophysical Monograph Series, Vol. 24, 1981, p. 103-120.

[3] Dietrich, J. H., Kilgore, B. D.: Direct observation of frictional contacts: New insights for state-dependent properties, Pure and Applied Geophysics PAGEOPH, Vol. 143, 1994, p. 283-302.

[4] Dietrich, J. H.: Modeling of Rock Friction I.: Experimental Results and Constitutive Equations, Journal of Geophysical Research, Vol. 84, 1979, p. 2161-2168.

[5] Dowson, D.: History of tribology, Longman, New York, 1979.

[6] Ruina, A. L.: Slip Instability and State Variable Friction Laws, Journal of Geophysical Research, Vol. 88, 1983, p. 10359-10370.

[7] N. Mitsui and P. Ván: Thermodynamic aspects of rock friction, Acta Geodaetica et Geophysica, Vol. 49, 2014, p.135-146, (arXiv:1312.4930 [physics.geo-ph])

[8] Ván P.: A képlékenység termodinamikája. In: Fülöp T. (szerk.) Idő és térderiváltak anyagtörvényekben. Mérnökgeológia-Kőzetmechanika Kiskönyvtár 10, Műegyetemi Kiadó, Budapest, 2010, pp. 15-50.

[9] A. Csátár; F. Safranyik; G. Bércesi: A NEW direct shear testing apparatus for the examination of the velocity- and time-dependent friction, Hungarian Agricultural Engineering 25; p. 54-58; (ISSN 0864-7410)



LOOKING BEHIND THE PROCESS OF PYROLYSIS IN WASTE MANAGEMENT: QUESTIONS ON THE COMPOSITION AND QUALITY OF END-PRODUCT AND THEIR ANSWERS BY MEAS OF ANALYTICAL CHEMISTRY

Author(s):

K. Lányi¹, E. Molnár¹, I. Vanó¹ and P. Korzenszky²

Affiliation:

¹Faculty of Economics, Agricultural and Healthcare Studies, Szent István University
Szabadság út 1-3., Szarvas, H-5540, Hungary, Tel.:+36 66 561630

²Faculty of Mechanical Engineering, Szent István University, Páter K. út. 1, Gödöllő, H-2100, Hungary

Email address:

lanyi.katalin@gk.szie.hu, Molnar.Erik@gfh.szie.hu, Vano.Imre@gek.szie.hu, Korzenszky.Peter@gek.szie.hu

Abstract

Recycling technologies gained increased importance in the past decades, since environmental issues and the questions of depleting natural resources. Wastes may be considered as resources of valuable secondary raw materials. This literature review aims at compiling the information available on questions arising from the differences between the chemical composition of traditional fuels and chemical industrial raw materials, together with the analytical chemical methods being able to answer these questions. Issues of technical optimisation, the composition of end-products, and their dependence on the technical parameters of pyrolysis will also be discussed.

Keywords

pyrolysis, waste recycling, secondary raw materials, energy from waste

1. Introduction

According to a recent World Bank study (Hoornweg and Bhada-Tata, 2012) 70% increase is forecasted in the municipal solid waste globally, from the annual amount of 1.3 billion tonnes presently to an estimated 2.2 billion tons by 2025. It means also a vast increase in the solid waste management costs from \$205 billion to \$375 billion in the same term. Developing countries face the greatest challenge, however, the burdens of developed countries will also not decrease.

In the European Union, the 2004/12/EC Directive regulates the issues of packaging and packaging waste. According to this Directive, minimum 60% of packaging waste shall be recovered or incinerated at waste incineration plants with energy recovery; between 55 % and 80 % of packaging waste shall be recycled. For plastics in packaging waste the minimum recycling target of 22.5% shall be attained counting exclusively material that is recycled back into plastics. This requirement, together with the ever-growing amounts of solid waste, puts European governments and the environmental technology sector under great pressure in the field of waste recycling.

Due to the previous, the importance of waste management processes will increase that are:

- cost-effective
- the cost-benefit ration can be improved further via producing secondary energy resources or raw materials
- do not produce significant amount of any further waste to be disposed.

Recycling technologies gained increased importance in the past decades, since the environmental issues caused by the still growing amount of wastes cannot be left unconsidered anymore. At the same time, wastes may be considered as resources of valuable secondary raw materials, such as pyrolysis gas (PG) used for energy production and pyrolysis oil that can be used as fuel or as a raw material in the chemical industrial processes. Many researches dealt with the questions of technical optimisation, the composition of end-products, and their dependence on the technical parameters of pyrolysis. However, the environmental consequences of the pyrolysis process itself as well as the compliance of pyrolytic end-products with the regulatory environment have been treated to far below their importance. Moreover, the available scientific methods being able to handle these questions of compliance have not been collected yet.

This literature review aims at compiling, as far as possible, the information available on questions arising from the differences between the chemical composition of traditional fuels and chemical industrial raw materials, together with the analytical chemical methods being able to answer these questions. International standards and legislative prescriptions will be compared to the composition data from literature, as well as, the main problem-areas will be highlighted. Analytical chemical methods suitable to aiming these areas will be collected and presented. Consequences will be drawn in order to support the efforts made for more effective re-utilization of wastes of high carbon content, and to highlight the possible traps and difficulties in these processes.

2. Discussion

Issues of chemical composition in waste pyrolysis

The dependence of plastic materials' thermal decomposition on the technical parameters have been studied intensively in the

last decade. Among many other interesting findings, it was determined (Lopez-Urionabarrenechea et al, 2012) that stepwise catalytic pyrolysis can be a useful alternative for recycling mixed plastic waste, however, if PVC is present in the original mixture, it will lead to unfavourable levels of chlorinated organic compounds in the pyrolysis oil, which causes reduced utilisation options as a secondary raw material. Influence of time and temperature on pyrolysis behaviour of plastic wastes was also an intensively studied issue.

A very important technical parameter of pyrolysis is the temperature of reaction. Many investigations dealt with this issue, but the results are not in harmony with each other every time. A Spanish research group found (López et al, 2011a) that by raising pyrolysis temperature, gas yields significantly increase to the detriment of liquid yields. 460 °C was the lower temperature at which total conversion could be achieved. However, the liquids appeared to be extremely viscous which meant difficulties in handling. 500 °C seemed to be the optimal temperature for plastic waste pyrolysis, in terms of both conversion and quality of the pyrolysis liquids. Reaction time in the range 15–30 min seemed to be enough to achieve total conversion of the plastic waste. The obtained ratios of different pyrolysis end-products can be seen in the Chart 1.

Chart 1. Effect of temperature on pyrolysis yields (wt%). (López et al, 2011a)

Temperature (°C)	Liquids	Gases	Solids
460	72.0	26.9	1.1
500	65.2	34.0	0.8
600	42.9	56.2	0.9

In an other research, Chinese researchers (Lin, 2009) found that with a fluidized-bed reactor system, excellent heat and mass transfer, and much less proneness to clogging with molten

polymer could be reached at 390 °C. The technology used gave a nearly constant temperature throughout the reactor. The fluidizing cracking reactions were shown to be a useful method for the production of potentially valuable hydrocarbons.

The effect of catalyst can be also a determining factor in obtaining the desired end-products from the pyrolysis process. Researchers showed (López et al. 2011b) that ZSM-5 zeolite is a rather active catalyst for plastic waste pyrolysis; on the one hand, it promotes gas production and causes lower molecular weight and higher ratio of aromatic compounds in the liquids phase even at low temperatures. In this research, Red Mud showed also noticeable activity in plastic waste pyrolysis. However, it needed higher temperatures than zeolite: it showed no activity at 440 °C while at 500 °C it increased gas yields, decreased liquids viscosity and promoted liquids aromatization, which are all important factors of further utilization. The comparative results of this research can be seen in the Figure 1.

Without catalysts and at atmospheric pressure the pyrolysis process shows different characteristics (Miskolczi and Nagy, 2012), however, the end-products are similar. But the ratio of different phases, and the composition of the end-products can differ strongly. In the pyrolysis oil, paraffin, olefin, aromatics and naphthenic hydrocarbons were found that made the material favourable for further energetic applications.

Pyrolysis temperature has also significant effect on the composition of the pyrolysis liquids, which is a determining factor in the further utilization options. Owing to this fact, the question of temperature can be a key factor in balancing the cost-effectiveness of the pyrolytic waste management processes. Researchers found (Lee and Shin, 2007) that 50 °C change in the reaction's temperature resulted in significant changes in the composition of pyrolysis oil. Decreasing the temperature from 400 °C to 350 ° caused the amount of aromatic hydrocarbons to decrease slightly, and the open-chain paraffins to decrease significantly. At the same time, the amount of open-chain olefins increased by the decrease in temperature (see figure 1).

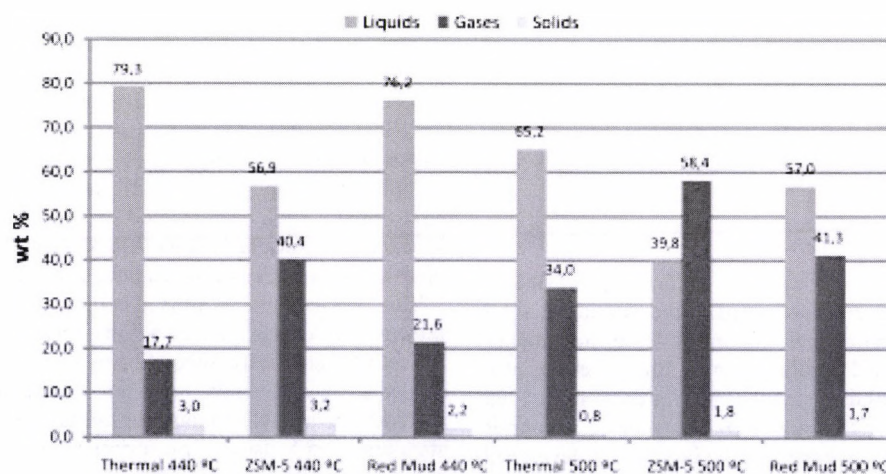

Figure 1. Pyrolysis yields (wt%) as a function of temperature and catalyst used. (López et al. 2011b)

Despite the differences in the findings in issues of temperature, or catalyst, researchers generally agree on the significance of the chemical composition of raw waste to be pyrolyzed. Spanish researchers studied intensively (López et al, 2010) the question of pyrolysis raw materials and their effects on the composition of end-product. They studied four different types of incoming waste-mixtures rejected from waste management plants: samples 1 and 2 contained more than 90 wt% packaging plastics while such

materials were much less abundant in samples 3 and 4, which contained more than 30 wt% of materials inappropriate for pyrolysis. Sample 1 contained about 98% packaging materials while samples 2, 3 and 4 had unusually high film, paper and glass contents. According to their study, the composition of the raw material played a very important role in the distribution and quality of the pyrolysis products. Figure 3. shows the details of the secondary analysis of data from this research.

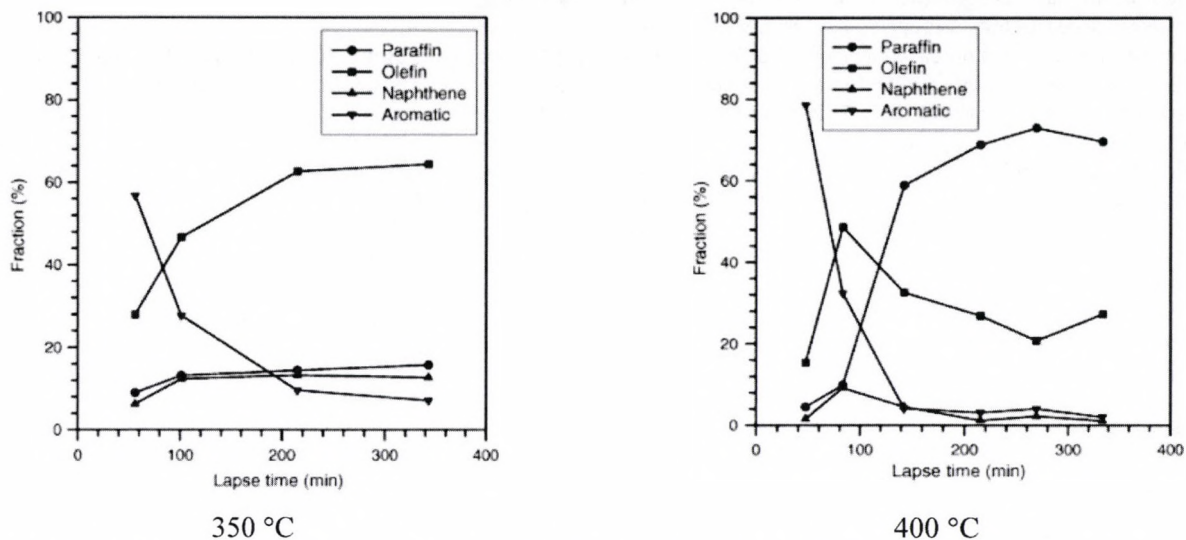

Figure 2. Distribution of compounds of interest in the liquid product of pyrolysis at 350 °C and 400 °C, respectively (Lee and Shin, 2007)

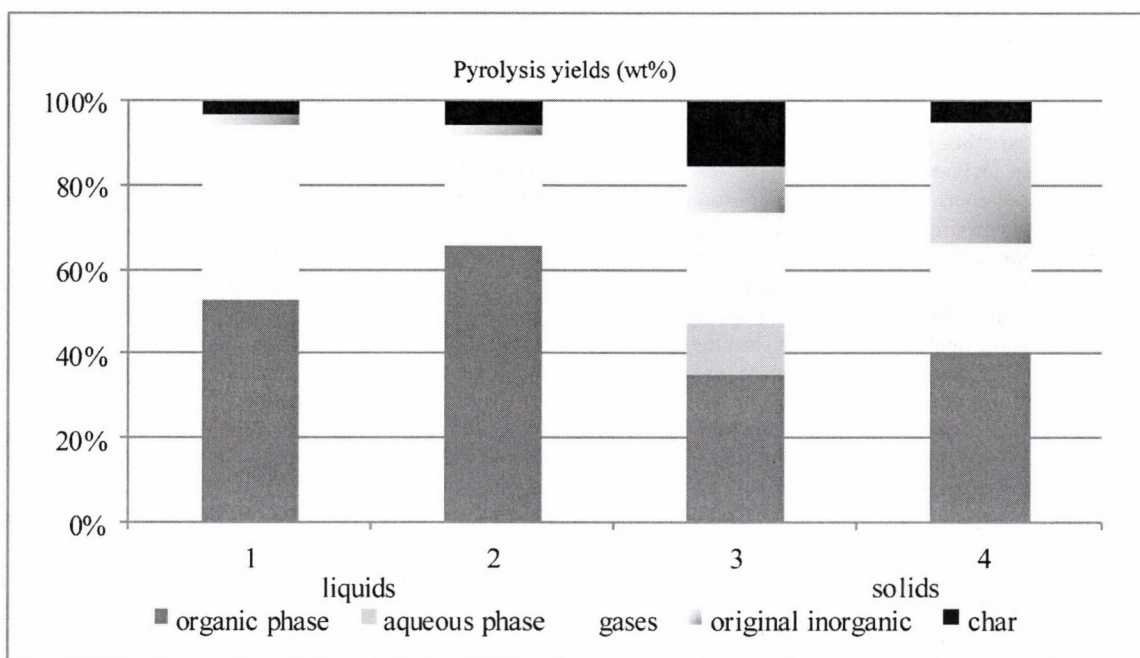

Figure 3. Pyrolysis yields of various waste mixtures (own compilation by López et al. 2010.)

According to the professionals in the field (Hancsók et al, 2013), the materials used as fuels shall comply with the following requirements, as the most important ones:

- good combustion characteristics
- high octane number (petrol), or cetane rating (diesel oils)
- flame temperature is not too high
- lower level of pollutant emission
- very low level of sulphur (≤ 10 mg/kg)
- decreased level of aromatic compounds (petrol: benzene $\leq 1,0$ v%; total aromatics ≤ 35 v%; diesel oils: polyaromatic hydrocarbons: ≤ 8 v%)
- decreased level of olefins (petrol: ≤ 18 v%).

It can be clearly seen, that the requirements for utilizing the pyrolysis oil as fuel, or as a secondary raw material in the chemical industry (re-polymerisation, etc.) contradict each other significantly.

Analytical chemical procedures

From the previous, it can be clear that the sulphur content is a key factor in the utilization options of pyrolysis oils. According to the ASTM D 3246-96 standard determination of sulphur in petroleum gas is done by microcoulometric analysis of the product. In addition to the difficulties caused by the complex method requiring high level of expertise and specialised equipment, the detection limit of this method (1-100 ppm) makes it unsuitable for characterizing pyrolysis oils. Several alternatives appeared in the literature, from the rather old idea of using gas chromatograph coupled with flame ionization detector (GC-FID) for determining the sulphur content of petroleum products (Visser et al, 1981), to the most up-to-date approach of X-ray fluorescence (XRF) spectrometry used also by the ASTM D7039-07 standard.

Amount of aromatic compounds can be also important and shall be investigated carefully. European standard EN 12916:2006 determines the aromatic compound content of petroleum products by high-performance liquid chromatography coupled with refractive index detector (HPLC-RI). This robust method is reliable, fast and relatively easy to carry out. However, the total aromatic content of pyrolysis oils can be out of the range of this method (7-42 m/m%). Alternative method can be the Fourier transformation infrared spectrometry (FTIR) (Khanmohammadi et al. 2013), or gas chromatograph coupled with mass spectrometer (GC-MS) (Sandercock, Du Pasquier, 2003). However, the detection limits, especially the too high level of analyte to be determined can be a problem also in the case of these alternatives.

3. Conclusions

In the recent decades, pyrolysis of plastic wastes proved to be a reliable and useful method for decreasing solid waste instead of landfilling it. However, the fate of end-products from this process rises many questions in the field of chemical composition, which determines further utilisation options, and therefore influences strongly the cost-effectiveness – and thus the sustainability – of the whole process. Although the pyrolysis oil – the most intensively utilised fraction of pyrolysis products – is rather similar in its physical appearance to traditional diesel oils, its chemical composition can differ from it significantly, therefore the simple substitution of diesel oils by pyrolysis oil in machines is questionable. On the other hand, the more and more strong requirements towards technologies resulting in low carbon dioxide loads lead researchers to study other utilisation options for pyrolysis oils not involving combustion: re-polymerisation, or other chemical industrial processes. For these utilisations different chemical composition can be needed that for combustion technologies. The industrial standards for petroleum products in the field of composition analysis have only limited use for analysing pyrolysis oils, due to the differences in chemical composition and the difference in utilisation options. Further investigations in the field of analytical chemical methods will be required in order to promote the technological and economic sustainability of waste pyrolysis processes.

4. Acknowledgements

This research was supported by the Hungarian Government and the European Union, with the co-financing of the European Social Fund, within the framework of the TÁMOP-4.2.2.A-11/1/KONV-2012-0015 project.

References

- [1] **D. Hoornweg and P. Bhada-Tata** (2012), What A Waste - A Global Review of Solid Waste Management. World Bank.
- [2] **A. Lopez-Urionabarrenechea I. de Marco, B.M. Caballero, M.F. Laresgoiti, A. Adrados** (2012), Catalytic stepwise pyrolysis of packaging plastic waste. *Journal of Analytical and Applied Pyrolysis*, Vol. 96. pp. 54–62.
- [3] **A. López I. de Marco, B.M. Caballero, M.F. Laresgoiti, A. Adrados, A. Aranzabal** (2011a), Influence of time and temperature on pyrolysis of plastic wastes in a semi-batch reactor. *Chemical Engineering Journal*, Vol. 173. pp. 62– 71.
- [4] **Yeuh-Hui Lin** (2009), Production of valuable hydrocarbons by catalytic degradation of a mixture of post-consumer plastic waste in a fluidized-bed reactor. *Polymer Degradation and Stability*, Vol. 94. pp. 1924–1931.
- [5] **Miskolczi, N. and Nagy R.** (2012), Hydrocarbons obtained by waste plastic pyrolysis: Comparative analysis of decomposition described by different kinetic models. *Fuel Processing Technology*, Vol. 104. pp. 96–104.
- [6] **A. López I. de Marco, B.M. Caballero, M.F. Laresgoiti, A. Adrados, A. Aranzabal** (2011b), Catalytic pyrolysis of plastic wastes with two different types of catalysts: ZSM-5 zeolite and Red Mud. *Applied Catalysis B: Environmental*, Vol. 104. pp. 211– 219.
- [7] **A. López, I. de Marco, B.M. Caballero, M.F. Laresgoiti, A. Adrados** (2010), Pyrolysis of municipal plastic wastes: Influence of raw material composition. *Waste Management*, Vol. 30. pp. 620–627.
- [8] **Hancsók., J.; Varga Z.; Eller, Z.; Pölcsmann, Gy., Kasza., T.** (2013), Liquid Alternative Diesel Fuels with High Hydrogen Content. 9th International Colloquium Fuels. January 15-17, 2013, Stuttgart/Ostfildern, Germany.
- [9] **R. Visser and A Hovestad** (1981), Determination of the total sulphur content in gas oils with a flame photometric detector. *Journal of Chromatography*, Vol. 204. pp. 153-157.
- [10] **M. Khanmohammadi, A.B. Garmarudi, K. Ghasemi, M. de la Guardia** (2013), Quality based classification of gasoline samples by ATR-FTIR spectrometry using spectral feature selection with quadratic discriminant analysis. *Fuel*, Vol. 111. pp. 96–102.
- [11] **P.M.L. Sandercock, E. Du Pasquier** (2003), Chemical fingerprinting of unevaporated automotive gasoline samples. *Forensic Science International*, Vol. 134. pp. 1–10.
- [12] **Korzenszky P., Puskás J., Mozsgai K., Lányi K., Mák Z.** (2014), Innovation possibilities of a thermolysis plant to be established in Hungary, 20th International Symposium on Analytical & Applied Pyrolysis, Birmingham, pp. 115.



APPLE CLASSIFICATION WITH SHAPE DESCRIPTION USING 3D IMAGING TECHNOLOGIES

Author(s):

A. Lágymányosi, I. Szabó

Affiliation:

Faculty of Mechanical Engineering, Szent István University, Páter K. u. 1., Gödöllő, H-2103, Hungary

Email address:

lagymanyosi.attila@gek.szie.hu, szabo.istvan@gek.szie.hu

Abstract

In agricultural crop classification color and shape are the mostly investigated characteristics. In most cases classification is traditionally carried out by people using simple visualization or by automated image processing. The aim of the image processing analysis, is to search for specific shape properties of crop class, or give a description of the specific geometry of the total crop. The applied image resolution is critical parameter regarding image processing procedures. The high-resolution image data might be significantly large and so the processing usually slow, while on the other hand the essential shape characteristics may be lost due to the few pixels in the case of low resolution. In the imaging studies of shape characteristics fundamentally two main lines are being distinguished. One is the conventional two-dimensional imaging, and the other is the image analyses applied on 3D images. In this article a 3D image based evaluation technique is presented which provides an additional method to apple grade classifications. With this method the conventional identification used to classify apples can be extended and so the accuracy can be improved.

Keywords

3D-imaging, image processing, shape feature

1. Introduction

There are several different features need to be defined together in order to precisely describe an apple. These main characteristics are colour, smell, flavour and shape. Traditionally, to assess these features the manual examination by using human sensory organs, such as vision, scent and taste, is inevitable. To define shape and colour the vision of the inspector is needed.

When machines are used for identification of the above mentioned characteristics devices with various operational principles are needed [3]. For example, in case of flavour the so called artificial tongue, while to recognize shape and colour artificial vision or machine vision is the appropriate solution [1]. The applied image processing procedure needs entirely different principles for colour and shape description.

Some of the shape characteristics of an apple can be derived from a conventional two-dimensional image [4]. In this case, the information is provided by the shape of the apple's projection.

The inspector, however, evaluates the fruit in three-dimension as default. Therefore, the person also sees the shape of those parts which remain hidden on a projected image. So as to describe an apple's characteristic shape in two dimensions it is sliced lengthwise and width wise resulting in longitudinal and cross section.

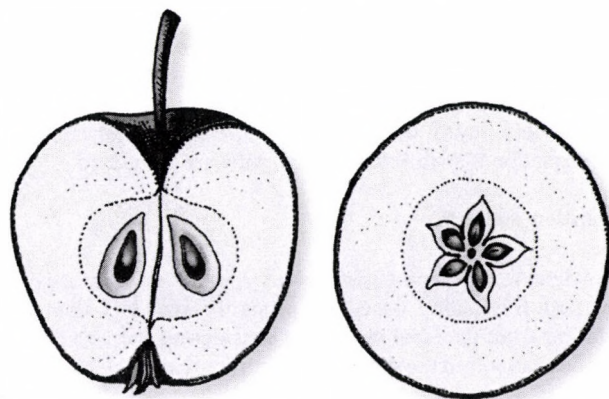

Figure 1. The apple section planes

After the fruit has been sliced sections can be well defined by means of two-dimensional image acquisition methods. This way the features of core can also be assessed which, in this particular case, is another important piece of information. Nevertheless, it is a destructive method in which the value of the fruit will finally be lost.

In classification for quality the core parameters are usually not relevant. In this case, the main classification features are shape, colour and size which are external characteristics [2]. The shape characteristics are specific to a variety and changes (possible deformations) are used as basic quality classification factor. This is underpinned by the fact that specific shape does not necessarily define a variety but a variety has specific shape characteristics.

By using three-dimensional imaging the 3D image of the apple can be acquired. Compared to a two-dimensional image this contains numerous pieces of information concerning shape [6]. The information, however, remains hidden within the data. Dataset can be larger with orders than in case of a simple two-dimensional image. So the hidden information within a three-dimensional image can provide with many additional shape attributes but these can only be derived from the descriptive dataset with an appropriately chosen mathematical model. At

present, the most limiting factor detaining the spread and use of 3D technologies is the difficulties with handling such large volume of data. Therefore, the general aim of the researchers, working on the area of 3D imaging, is to search and develop such algorithms by which data volume and processing time be reduced significantly [5]. There are no universal, generally applicable image processing methods! With regard to this, the ultimate aim is to always identify and develop a problem-specifically designed and tuned algorithm. In case of the 3D-image-based-apple-classification, the aim has been the same.

2. Applied system elements

In order to exclude the measuring errors originated in the operational principle 3D scanner two 3D scanners, with two operational principles, were used.

a./ A laser scanning:

3D laser scanner of the type Zscanner 700 was used. The main technical parameters were: sampling rate 18000 sample / sec., 2 built in cameras, improved resolution of 0,1 mm, maximal accuracy of XY positioning is 50 µm if the investigated volume is 100 mm x 100 mm.

b./ Procedure based on a projected contrast grid (dark and bright bands):

Breckmann optoTOP –HE 1097 where the Sensor Principle of operation Miniaturised Projection Technique with Light source 100 W halogen, Imaging High resolution digital camera Digitizing 1384 x 1036 pixels, Operating distance from approx. 50 mm, Min. depth resolution 2 µm, Acquisition time < 1s.

For 3D image acquisition to evaluate an apple the original software of scanners were used.

Files were saved with *.stl extension. For mathematical transformation Matlab and MS Excel software were used.

3. Applied method

According to the hypothesis a given apple variety is usually classified for quality based on primarily size and then on deviation from the ideal shape. By considering the size based classification solved the shape characteristics remain in the centre of interest.

An ideal apple is considered as symmetric on the axis that connects the stem and the calyx. Parameterizing the deviation from the ideal the increase of deviation can be defined as quality reduction. By having an unambiguously quantified value which expresses the deviation of an ideal apple an exact classification into quality classes will be feasible.

The deviation can be measured in several ways. From these methods the one, which can squarely described, repeated and validated must be selected. Furthermore, the selected method should use simple calculation mechanism on preferably few input data.

The above described criteria can only be fulfilled if a well-defined reference system can also be provided. For example, the lengthwise section of an apple will obviously depend on the direction of slicing even if it is absolutely perpendicular to the width wise axis.

The fundamentals of the new method, developed by authors are the followings:

- ensuring standard resolution in case of all measurement,
- transformation to a uniform orientation system,
- easily calculated and validated quality parameters.

Images generated by 3D scanners contain measuring points in altering densities on the object's surface. The alteration is caused

by the orography of surface. The contiguous and ruption-less surface is usually described by triangulation method and with the normal vector of the surface elements. Drawback of this technique is that during generating a section a surface where no measured data available can be sliced.

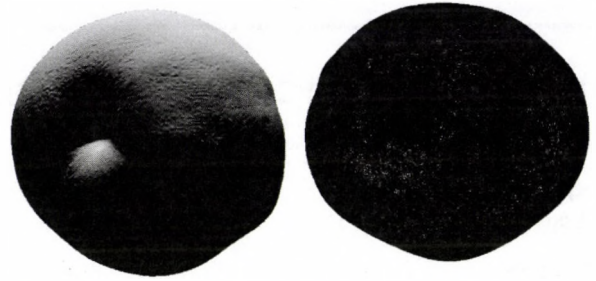

Figure 2. An apple with original *.stl and with variable from matrix

Ensuring standard resolution

In order to ensure same number of points that form an object a predefined (100x100x100) matrix was created uploaded with 0 values. After this, the original 3D dataset's minimum coordinates were translated to the origin. Then, all surface elements were assigned to each cell of the 0 matrix depending on the distance from the origin. In this selected cell the value was changed to 1. This was a matrix was created where all characteristic positions of surface are 1 and every other position is 0.

All surface elements' position was defined with closed surface with 1% accuracy at standard resolution.

This transformation resulted in (depending on the size and shape of the apple) 1/8 to 1/10 less surface elements than the original scanned image.

Change to a uniform orientation system

During the measurement the origin of the coordinate system and the lengthwise direction of apple depend on which scanner was used and what was the starting position of apple at the beginning of scan. The logging of minimal values was done during ensuring the standard resolution. Nevertheless, due to the differently positioned apples the translation solely does not ensure uniform reference system.

As an origin of the uniform orientation system the apples' centre of gravity was chosen. In order to eliminate the effect of random rotation among the rotation axes along the centre of gravity of an apple, considered as homogenous body, the so called inertial main axes were selected. These axes are perpendicular to each other, pair wise.

Like this, a reference system was created where all apples' longitudinal axis overlaps with one of the reference system's main axes and the origin is situated in all apples' centre of gravity.

The procedure was carried out by with the following mathematical apparatus:

If the x, y, z variables represents the apple surface points.
 J_s the tensor of the moment of inertial to mass centre

$$J_s = \begin{bmatrix} \sum y^2 + z^2 & -\sum x * y & -\sum x * z \\ -\sum x * y & \sum x^2 + z^2 & -\sum y * z \\ -\sum x * z & -\sum y * z & \sum x^2 + y^2 \end{bmatrix}$$

$J_{s,p}$ the tensor of the primary axis, where the $\lambda_1, \lambda_2, \lambda_3$ the J_s eigenvalues

$$J_{s,p} = \begin{bmatrix} \lambda_1 & 0 & 0 \\ 0 & \lambda_2 & 0 \\ 0 & 0 & \lambda_3 \end{bmatrix}$$

With the $J_{s,p}$ create the Q matrix where the column represents the $\lambda_1 \dots \lambda_3$ eigenvectors

$$Q = \begin{bmatrix} \lambda_{1x} & \lambda_{2x} & \lambda_{3x} \\ \lambda_{1y} & \lambda_{2y} & \lambda_{3y} \\ \lambda_{1z} & \lambda_{2z} & \lambda_{3z} \end{bmatrix}$$

Finally to the coordinate transformation was used the next equation

$$\begin{bmatrix} x' \\ y' \\ z' \end{bmatrix} = Q \begin{bmatrix} x \\ y \\ z \end{bmatrix}$$

The selection and creation of the quality parameters

By using the standard resolution and uniform direction of matrixes several attributes were examined. These were the comparison of torque on the selected main axes, the torque ratios on the main axes of a particular apple's and the distance between the origin and main axes' points intersecting the surface.

According to authors' experience the deviation from an eye-appeal, variety specific shaped apple are basically not the knobs on the surface but distortions, assumingly originated in development disorder. These distortions occurred near the stem and the calyx in various levels.

That is why the selected parameter, primarily due to the simple and quick calculation method, is the distance between the stem and/or calyx and the nearest main axis.

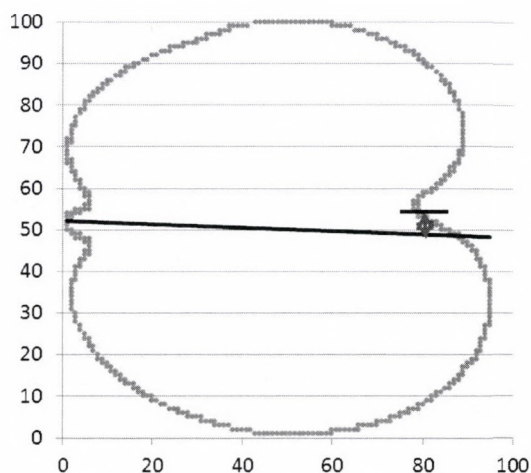

Figure 3. 2D slice with the difference from primary axis

4. The results

Authors have developed a method that creates a uniform reference system for evaluating the shape attributes of the apple. It is capable of treating the characteristic dataset uniformly, independently from size and orientation. Out of several shape features on have been selected that can be used to describe the apple distortion's level (deviation from ideal) by using a simple value, or value pair.

By completing the automatic classification of apples with this characteristic the quality of classification can be further increased.

References

- [1] **Bense L, Nagy I.** Robotok a gyümölcsösben. Agrofórum, 2013. 03: 146-149. ISSN 1788-5884
- [2] **Hajagos A,** et al The effect of rootstocks on development of fruit quality parameters of some sweet cherry (*Prunus avium* L.) cultivars, 'Regina' and 'Kordia', during the ripening process. 2012, Acta Universitatis Sapientiae, Agriculture and Environment, 4, pp. 59-70.
- [3] **Kátai L,** et al 3D Scanning and Computer Analysis of Morphological Aspects for Agricultural Applications. In: Hungarian Agricultural Engineering, 23/2011 December p.105-108. HU ISSN 0864-7410
- [4] **Blahunka Z. Faust D, Bártfai Z, Lefánti R.** Synergy of optical insect counter and mobile robot, Synergy in The Technical Development of Agriculture and Food Industry 2011, Gödöllő, ISBN:978-963-269-250-0
- [5] **Kátai L, Szabó I.** Digital Image Processing for Qualifying Chopped Plant Bulks. In: Hungarian Agricultural Engineering, 1997. 10. p.35-36.
- [6] **Molto, E.** et al An artificial vision system for fruit quality assessment Conference of European Agricultural Engineering, Madrid 1996, 96F-078

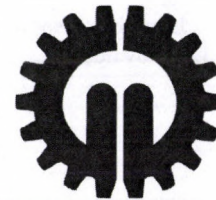

WATER MANAGEMENT IN MIDDLE EAST AND NORTH AFRICA

Author(s):

J. S. Zsarnóczai, Bahaa Asma, A. Vajda

Affiliation:Szent István University, Faculty of Economic and Social Sciences,
Institute of Regional Economics and Rural Development, 2103 Gödöllő, Páter Károly utca 1., Hungary**Email address:**

zsarnoczai.sandor@gtk.szie.hu, kekk@gtk.szie.hu, vajdandi@gmail.com

Abstract

In Middle East and North Africa (MENA) the natural water supply is very important for water consumption of population and the agricultural sector. The total available freshwater in MENA region is 467 billion m³ (km³) of which 81,8% is for only Middle East, and of which 70% is only for two countries, namely Turkey and Iran. The remaining 30% is availability for the Arab countries in Middle East (11,8%) and North Africa (18,2%). Also the other unfavourable issue for the MENA region (without Turkey), that only 22,7% of all available water is groundwater. The large portion of the surface water results in serious difficulties, because of the warm dry weather the water evaporation is very considerable.

The Great Man-Made River (GMR) Project would yield five times more water cost effectively than the earlier traditional water resource options before 1983. The Great Man-Made River Authority was created and invested with the responsibility of taking water from the aquifers in the south, and conveying it by the most economical and practical means for use, predominantly for irrigation, in the Libyan coastal belt.

These natural conditions show how the water use for irrigation has mainly been concentrating on two smaller regions of MENA, namely Nile river and cultivable agricultural fields between Euphrates and Tiger rivers as it has been called Mesopotamia for several thousands of years. The concentrated irrigated lands did not help to extend the improved technologies for irrigation; therefore the other sub-sectors of the agriculture cannot be developed, for example animal husbandry and plan production. The possible development trend of the technology and techniques can be solved by improving the renewable natural resource use from water, wind and solar energy within the sustainable investment; also we do not forget the salinization of sea water to make it be satisfactory drinking for population of these regions.

Keywords

Water supply, Groundwater, Surface water, Grate Man-Made River Project

1. Introduction

The study uses wide-side international scientific literatures and statistical data given by the international special organizations, the regional one and national institutions specialised in water use

and irrigation. The total available freshwater in MENA region is 467 billion m³ (km³) of which 81,8% is for only Middle East, and of which 70% is only for two countries, namely Turkey and Iran. The remaining 30% is availability for the Arab countries in Middle East (11,8%) and North Africa (18,2%). Also there is a significant difficulty, namely the soil degradation is mainly resulted by wind in North Africa, which needs forestry settlement (Yahia Ali Mughram - Zsarnóczai, 2008).

The social-economic demands need improvement of water using technologies and also to widen the water using diversification in MENA region, for example in field of energy resource production and use from renewable natural resources, as most important one is the water. The growth of population needs much more food production and in consequence of which, water use within unfavourable dry weather conditions based on the global warming process (Ligetvári et al. 2006, 96-97. p.). Naturally the natural conditions for water use is not favourable in MENA region, because the drought period almost without raining is extending for more than half of the year, which tendency has been keeping for the last several centuries.

2. Materials and Methods

The study analyses the water management in Middle East and North Africa emphasizing the similarities and differences of water conditions and use in several countries of these regions based on the compare methods. The compare methods use mainly statistical data characterizing the special given natural conditions for using water resources in fields of water supply for the agricultural sector, mainly for irrigation. Based on the SWOT analyses the study would like to focus on backwardness of MENA, as two regions from the real demand level for the water use and also the possible diversified water uses.

In general the approximate annual evaporate-transpiration rate, which we can call as the loss of water to the air, is almost higher by two or 20 times more than the averagely rainfall per year in this region. Water can be lost by the evaporation from surface, plants produced by farmers. Also 22,7% of all available water is groundwater in the MENA region, which can make more difficulty for the water supply. The natural and climatic changes of these two regions, namely the Middle East and North Africa need special water uses and irrigation system meeting the social demands, natural conditions and technical developed levels in countries of these regions.

3. Results and discussion

The Middle East and North Africa (MENA) region has very considerable difficulties concerning the environmental conditions, because, excluding Turkey, this region has 1.100 million hectare land where the humid zone is less than 10 percent of the region, the other 90% is dry or drier part of the region, where the 30% of population lives. Also the large scale irrigated areas are only 2% of this total area. The large scale irrigated area includes the Nile and Euphrates-Tiger river-valleys. While 20 million ha of land are irrigated, as 32% of 62,5 million hectare cultivated lands (FAO, No.33).

These natural conditions show how the water use for irrigation has mainly been concentrating on two smaller regions of MENA, namely in Nile river valley and cultivable agricultural fields between Euphrates and Tiger rivers as it has been called Mesopotamia for several thousands of years. The concentrated irrigated lands did not help to extend the improved technologies for irrigation; therefore the other sub-sectors of the agriculture can not be developed, for example animal husbandry and plan production. Therefore the technical backwardness could be more permanent, which led to the general backwardness for society of MENA region. Until now the developing trade of these regions and its possible incomes could not solve the wider future technical development and investments therefore the capital created by the even profitable trade should almost withdraw from these regions.

In 2000 the average yield of wheat was 1,4 ton per hectare. Comparably the average middle yield of wheat was 3 ton per hectare, and its good average yield was 6 ton per hectare in Hungary. In Middle East and North Africa region it often happens. Either forestry or cultivate plants production cannot decrease the wind influences for soil degradation, because the dry and warm climatic conditions cannot create adequate natural background for them. The other important difficulty is that the withdrawing groundwater in Libyan coastal, Nile Delta of Egypt and the Middle East's coastal areas. Because the water

withdrawing is very intensive mainly for agriculture, in this case in 3-5 km distance from the coast the freshwater is reduced and the sea water intruded and took positions closer to the surface. Pumps started pumping the salt water into the place of earlier ground fresh water. Continuously the level of the sea water flowing into place of the earlier freshwater increases over the sea level near to the coast. In order to discontinue this problem under face cistern system should be set up.

The highland mixed farming system is extending mostly in this region, while and also this farming system is laying in MENA region, as much as about 75 million ha, which includes 8 percent of population in both of regions. The farmers cultivate 22 million hectare, of which 5 million hectare can only be irrigated. Based on this farming system the producers can get rained cereal, legume cropping, tree crops, fruits and olives in terraces with vines from their lands. Also they use grazing animal husbandry technology by livestock mainly sheep, which is very famous from Iran to Morocco (see detailed in Table-1).

In the climatic conditions of tropical areas, the aridisols are extensive and they are characterised by strong potential evaporation exceeding precipitation mainly during most of the year. The soils cannot be cropped without irrigation. They have low level of soil organic matters associating with the lack of vegetation, because of low rainfall, chemical reaction. By the hand aridisols are can be quite productive if they are irrigated, by the other hand they can be so much saline. The parse – arid – farming system covers more than 60 percent of MENA region, which includes vast desert zones, and main soil is aridisols. About four million people lives within this farming system, as much about five percent of MENA region's agricultural population, who mainly lives in oases and in some of irrigation schemes of North Africa: from Morocco to Libya. 1,2 million hectare is irrigated and dates, other palms, fodder, vegetables are produced. Cattle, camels, sheep and goat are the famous for animal husbandry. Within this farming system grazing for the herds of pastoralists is going on (see in detailed in Norman et al, 1995).

Chart 1. Major Farming Systems of Middle East and North Africa
Source: FAO data

Farming Systems	Land-Area (% of region)	Agric. Population (% of region)	Principal Livelihoods	Prevalence of Poverty
Irrigated	2	17	Fruits, vegetables cash crops	Moderate
Highland Mixed	7	30	Cereals, legumes, sheep, off-farm work	Extensive
Rainfed Mixed	2	17	Tree crops, cereals, legumes, off-farm work	Moderate (for small farmers)
Dryland Mixed	4	14	Cereals, sheep, off-farm work	Extensive (for small farmers)
Pastoral	23	9	Sheep, goats, barley, off-farm work	Extensive (for small herders)
Sparse (Arid)	62	5	Camels, sheep, off-farm work	Limited
Coastal Artisanal	--	1	Fishing, off-farm work	Moderate
Fishing	--	1	Fishing, off-farm work	--
Urban Based	<1	5	Horticulture, poultry, off-farm work	Limited

In Libya

The idea of the Great Man-Made River was mooted at the General People's Congress on 3rd October 1983. This followed geological

revelations that up to 120.000 km³ of water lay beneath the Sahara Desert dating 14-38 000 years. It emerged that within a given budget, the Great Man-Made River (GMR) Project would yield five times more water cost effectively than the above three

options combined in October 1983, the Great Man-Made River Authority was created and invested with the responsibility of taking water from the aquifers in the south, and conveying it by the most economical and practical means for use, predominantly for irrigation, in the Libyan coastal belt.

The phase I. of the project was commissioned in 1990, and completed in November 1994. The system is able to supply 2.000.000 m³ of water per day to Benghazi, the second-largest city in Libya. The phase II. of the project finished in September 2000, completed the water supply section for the main city of Tripoli. It brings 2,5 million tones of water to Tripoli. The phase III. will increase water flow in the Phase I system by 1.680.000 m³/day while phase IV. will provide 1.000.000 m³/day of water through a pipeline to Tobruk. Phase V. will connect Phases I. and II, and install two power stations to pump the 1.000.000 m³/day of water. The Great Man - Made River aims at the mass transfer of waters from the Kufra and Sareer Basins beneath the earth surface to the coastal concentration of population in Benghazi, Sirte and Tripoli. Upon completion the huge network of pipelines will extend to about 4.000 kilometers and two aqueducts of some 1.000 km. The project will carry more than 5 million m³ per day across the desert and increase the size of arable land from 327.000 hectares (1991) by 60.000 hectares (1992) and another 180.000 hectares in the second half of the decade (Huda Fathi Salem et al, 2005; The Large Farm, 2005).

The animal husbandry has considerably developed since the first units of GMR Project started their operation. The favourable situations were established for interest of increasing plant production and animal husbandry. The FAO declared some basic principles for growth of MENA regions within several international panels a round meetings, of which participants could declare that

the GMR in Libya became one of the most successful investments of all of the developing countries, (UNDP/FAO, 2005):

- in the growth of the agricultural production based on the supports for farmers to buy agricultural machines, fertilisers, seeds with establishment of national sized advisory network to provide information for farmers and to build up the service network of machines;
 - promote co-operation between farmers in fields of selling and buying in order to increase food-self sufficiency, decrease of food-import, also to establish family farm units.
- The international organizations, like FAO and Arab League follow some main aims to be implemented in MENA regions, as follows:
- to follow the domestic market price system for agricultural and food products at low level for interest of domestic purchasing capacity and in the same time;
 - to realise the governmental financial support, by the other name direct payment for farmers, as well.

According to previous plans, number of these water reservoirs is in south west of Benghazi, to a total capacity of 76 million m³, with further reservoirs in the Sirt area sized at 37 million m³. Other smaller reservoirs are constructed in Nuwfaliyah, Bishr and for the existing development projects at certain wadis. Upon completion of the Great Man Made River Project, about 155.000 hectares of fertile land will be cultivated and irrigated by the water from the project. The reclamation and development of some 38.000 hectares south of the Benghazi plain served by the Ajdabiya-Benghazi line, and some 18.000 hectares on the Ajdabiya-Sirt line, has already started, in addition to preparations for irrigation of the existing wadi developments (Pallas, 1980).



Map 1. Water resources in Middle East with Euphrates and Tiger rivers
 Knowledge in English: 1. column: Water dams, irrigated areas, conflicts for water use.
 2. column: Mountain, ploughed areas, drought areas, Source: Larusse, Budapest, 2012

In Syria

There are 141 dams in Syria with a total storage capacity of 15,8 km³. The largest dam is located at Al-Tabka on the Euphrates. It forms the Al-Assad lake with a storage capacity of 11,2 km³. The majority of these dams are located near Homs and Hama. Concerning the irrigation and drainage development, estimates on irrigation potential, based solely on soil resources, were about 5,9 million ha, which is roughly equal to the cultivable area. Considering the water resources available at present, irrigation potential is estimated at 1.250.000 ha. Syria depends on international agreements with neighbouring countries on the sharing of river waters in the future (Haddad - Zsarnóczyai, 2008).

The interior region plays considerable role for agricultural production. Surface irrigation is reported to be practiced on 981.273 ha. The predominant system of surface irrigation practiced is basin irrigation. Traditionally, irrigation in Syria has relied on flooding for cereals, furrow irrigation for vegetables and basin irrigation for fruit trees. Sprinkler irrigation is practiced on 30.000 ha, mostly in the Homs, Aleppo and Al-Hassakeh governorates. It has been developing on a wider scale recently,

mainly because of groundwater scarcity, which has encouraged farmers to develop water-saving techniques, and because of equipment becoming available on the local market. Micro-irrigation is practiced on 2.000 ha. Earlier in 1993 it was estimated that 60,2% of the area was irrigated from groundwater and 39,8 % from surface water (gravity-fed or pumped from the rivers and lakes). The increase in irrigation from groundwater is the large number of farmers with small farm holdings. The latest available data estimate that over 75% of the farmers have holdings of less than 10 ha. On average, it is estimated that a household has 3,5 ha of irrigated land. Since most private farmers want secure and independent access to a supply of water. (Ministry of Agriculture and Agrarian Reform, 2005, see the Map).

Of the total area of 1.013.273 ha equipped for irrigation, 349.820 ha are involved in government irrigation projects and 78% of this land is also equipped for drainage. It is estimated that 105.000 ha of these government irrigated areas need rehabilitation. The irrigated area produces over 50% of the total agricultural production on about 18,6% of the cultivated land. Irrigated agricultural areas have already been seriously reduced in the Damascus basin in recent decades (see Chart 2).

Chart 2. Government's projects in Syria in 2000s
Source: UNDP/FAO (2005): Improved management of water resources for agricultural use (phase II). SYR/90/001. Damascus, Syria.

Size	Criteria	Total area in ha	as % of total
Large	> 20 000 ha	257 860	74
Medium		47 840	14
Small	< 2 000 ha	44 220	12
Total		349 820	100



Map 2. Water resources in geographical map of Middle East
Source: Larusse, Budapest, 2012

The Government projects extended on 349.820 hectare area, which includes large, medium and small scale farms. The small scale government project is under 2000 hectare, but large scale project over 20.000 hectare areas. The Syrian Government wants to ensure the food supply for sharply increasing population based on established governmental agricultural projects, as state-owned farms. There is a wide variation in cropping patterns in the irrigated areas, depending on the water resources available and the agro-climatologically conditions. Strategic crops such as wheat and cotton are concentrated in the northern and eastern part of the country. More than 50% of the wheat and cotton produced comes from the Al-Hassakeh governorate, in the north-eastern part of the country. (UNDP/FAO, 2005; see Table-2). Preparing inventories of technologies, knowledge, know-how and practices, also traditional and modern technologies should be used for implementing modernization for irrigation system. The sustainable agriculture means to remain highly developed

agricultural production level to supply foods. Promote national and multinational cooperation to realize main aims against effects of drought (Stekauerová Vlasta - Nagy: 2006, 289. p.).

According to the FAO guidelines on water quality for irrigation a severe restriction for irrigation is indicated when the electrical conductivity of the water exceeds 3ds/m. Water samples from three wells north of Deir el-zor within the steppe area have been analyzed. The EC values were ranging between 7 and 10 ds/m. Furthermore the guidelines also indicated limits for specific ion toxicity. In the analyzed samples sodium and chloride are found to be the dominant cations and anions respectively. A severe restriction degree is given in the guidelines when the concentration exceeds 9 meq/l for sodium and 10 meq/l for chloride. This concentration and the composition of these salts are considered the analyzed samples and similar waters are not suitable for irrigation (FAO-MAAR, 2001).

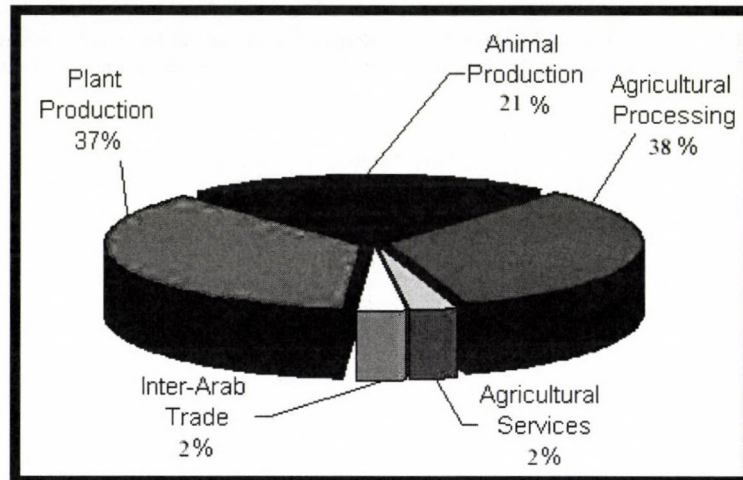

Figure 1. AAAID has sector distribution of this organization's costs and investments
Source: Annual Report of AAAID, Khartum, 2008

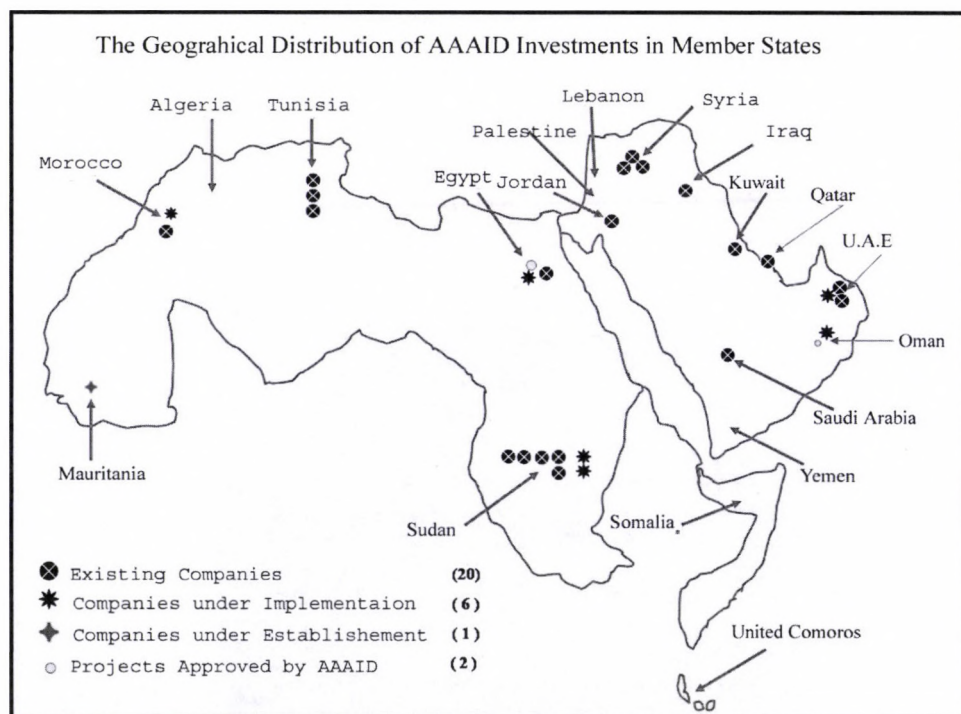

Figure 2. Distribution of Projects and Companies among Member States of AAAID
Source: Annual Report of AAAID, Khartum, 2008

Additionally to the irrigation and agricultural development at national level the international Arab organization like the Arab Authority for Agricultural Investment and Development (AAID) wants to strengthen the cooperation among Arab countries, as member states of this organization in field of agricultural and food industry development. This AAID is a regional financial and investment institution established in 1977, which has its centre in Khartoum, in Sudan. The AAID has been established and extended by 18 member countries, which are as follows: Saudi Arabia, Kuwait, Sudan, Iraq, United Arab Emirates, Qatar, Egypt, Algeria, Morocco, Mauritania, Somalia, Syria, Tunisia, Oman, Jordan, Lebanon, and State of Palestine, Yemen. At the beginning the Capital of this organization was as the total Authorized Capital of AAID as 150 million Kuwaiti dinars (approximately 495,0 million US Dollars).

At present AAID focuses on to invest projects increasing comparative advantageous for the production of food and agricultural products, for example cereals, specially wheat; vegetable oil, specially sunflower, sesame, peanut, cotton seed, olive oils; forages, specially alfalfa(jet), sorghum, and barley; sugar; milk and milk products, poultry, fish. Also the AAID gives priority for agricultural inputs, specially fertilizers, veterinary medicines and machines (see the Figure: sector distribution of this organization's costs and investments).

4. Conclusions

1. The possible development trend of the technology and techniques can be solved by improving the renewable natural resource use from water, wind and solar energy within the sustainable investment; also we do not forget the salinization of sea water to make it be satisfactory drinking for population of these regions. As Fogarassy et al, (2014a, on p. 1.) declared about the difficulties about calculating in advance the positive and negative long-term impacts of a sustainable investment, or a development venture. Then they declared how serious global problems arising from the fact that numerous environmental-protection oriented private and government ventures are implemented in an incorrect manner significantly impair the conditions of both the environment and the economy (market). There is a high number of innovative energy related investments, waste and water management projects, etc. in Europe, which cause more harmful effects than was earlier. Naturally it is true as above mentioned authors have right, that the innovative investments are needed for creating sustainable investment based on the environmental technology. But the MENA regions' countries have capital lack economies; even mostly the oil-crude exporting countries have this one, which obstacles their developing transfer technology in direction environment friendly one within as sustainable investments.

Naturally countries of MENA region should increase advanced technology of food manufacturing industry in order to increase highly value added of food products for export based on the comparative advantageous of these products. Also the highly level of irrigation investment cost can increase the domestic consumption prices of food products, in spite that the farmers do not pay fee for water-use. The agricultural development strategy including irrigation system network build up needs to increase qualitative level of agricultural and food products.

The developed farm management conception can be capable for sustaining agriculture based on projects to be achieved successfully by using foreign expertise and managers in these projects for applying high-tech production methods.

The Small-scale Irrigation Sub-System cannot adapt advanced irrigation technologies with rivers and water channels. This irrigation system extends in small perennial streams, in oasis or

areas belonging to flood of river water. This irrigation system can successfully base in case of cereals, fodder, vegetables and fruits.

2. Fogarassy et al (2014b, on p. 3228) focus on the importance on the decision makers, who must take the prevention of environmental problems, and other economic problems into consideration, which can surface due to the cessation of various products and processes. Without including the benefits and setbacks of these consequences, there can be no decision (Fogarassy et al, 2014b; on p. 3228). From this point of view the prevent needs technology developed based on the environment friendly.

Syria and Libya both of countries are depend from food import, and food export compulsion for re-paying foreign-credit, very strong demand for foreign technical equipment, lack of experts, farmers are not experienced. Not considerable use water is for energy resource, as renewable one. But in Libya there were more favourable supply capital resources, less population, almost desert area, 1% of and is irrigated, drought weather all of the year, salinization process more in the cost area.

In Syria the lack of capital, favourable cultivable land, more longer period of reining in a year, less occurs for appearing salt in continental areas are closed to cost, wider side dam net-work with more natural water supply, which elements characterize the agricultural sector and the irrigation possibility.

3. According to the natural and geographical conditions in the MENA regions the volume of soil water is so much different, for example it is not significant in Egypt and some countries of the Arabian Peninsula. The soil water cannot play significant role of MENA region, it can be important to discover groundwater storage, which can ensure water resource for irrigation. In some countries of the MENA regions the soil water contributes to less than 20 per cent of the national water use, for example in case of Jordan. In the other MENA countries, for example Turkey, Syria and Iran, which do not have considerable soil water during almost year, but rainfall can provide soil water for winter season, which can ensure some of water resources for dry-land farming and grazing. The soil water considerably contributes to increase agricultural yield and food supply for population of this part of MENA region (FAO, No.33).

4. Because the costs were so difficultly established and because much of the desalination activity is concentrated in economies that operate in a privileged world of oil enrichment it is not easy to provide reliable opportunity costs or definitive predictions of what the costs will be in the future (FAO, No. 33). The re-use of water has played a major role in the use and management of water in areas where topographic circumstances allowed water to drain from irrigated fields to those located at lower levels further down the system. According to the international estimations the national level Egyptian water utilization in agriculture, through re-use, is about over 70 per cent.

Also there are some main components in investment projects, which are as follows: 1/ the construction of a water treatment plant; 2/ rehabilitation of a large pipeline; 3/ construction of high capacity reservoirs.

5. As Fogarassy et al (2014c, on p. 33) focus on the importance of the „transition thinking”, which is a normative and practice oriented approach on sustainability development. Naturally the leaders of countries in MENA regions also have to follow this sustainable approach in order they can improve environment friendly technology. They authors have right to implement the knowledge of different fields of science, extended with practice experience. (Fogarassy et al, 2014c, on p. 33).

References

[1] FAO (No.33): Yield response to water. Irrigation and Drainage Paper, Rome

- [2] **FAO-MAAR** (2001). "The Utilization of Water Resources for Agriculture in Syria". FAO Report GCP/SYR/006/ITA.
- [3] **Fogarassy Cs, Bakosné Böröcz M, Molnár S** (2014a): Process of sustainable project development with Rubik's Cube using Game Theory interpretations. *International Journal of Advanced and Innovative Research*, 3: (10) pp. 1-6. <http://ijair.jctjournals.com/>
- [4] **Fogarassy Cs, Bakosné Böröcz M, Molnár S** (2014b): Sustainability Relations for Innovation, Low-Carbon Principles for "Rubik's Cube" Solution, *International Journal on Recent and Innovation Trends in Computing and Communication* 2: (10) pp. 3226-3232. <http://www.ijritcc.org/>
- [5] **Fogarassy Cs, Szarka K, Lehota J** (2014c): The „transition thinking” and 50plus generation thoughts of sustainability in different countries (case study in Hungary and Switzerland), *International Journal of Advanced Research in Management and Social Sciences* (ISSN: 2278-6236) Volume 3, Issue 11, November 2014 pp. 33-48 <http://www.garph.co.uk/index.html>
- [6] **Haddad G., Zsarnóczai J. S.** (2008): Geographical background for agriculture in Syria. (A mezőgazdaság földrajzi háttere Szíriában). VII. Alps-Adria Scientific Workshop on Soil-Plant Interrelations, Session: Land Use II., Stara Lesna, Slovakia, 28 April – 2 May, 2008. Edited by Hidvégi, Szilvia. Volume 36, Supplement 2008. Akadémia Kiadó. Pp. 1019-1022. (XXII.), Abstract p. 1019, ISSN 0546-8191
- [7] **Huda Fathi Salem, Villányi L., Karim K, Zsarnóczai J. S.** (2005): The Great Man-Made River Project and Its Importance in Libya. (Az ember alkotta nagy folyó beruházás és ennek fontossága Líbiában). *Bulletin of the Szent István University, Gödöllő*, pp. 227- 236., Abstract p. 227. ISSN 1586-4502
- [8] **Ligetvári F, Várallyay Gy, Schweitzer F.**(2006): Sivatagok és az elsivatagosodás nemzetközi éve, UNESCO 2006. *Agrokémia és Talajtan*, Vol. 55. No. 2 pp 487-498.
- [9] **Ministry of Agriculture and Agrarian Reform** (2005): Report: Balance of land utilization for 2005. Damascus, Syria
- [10] **Norman M J T, Pearson C J, Searle P G E,** (1995): The ecology of tropical food crops. Cambridge University Press, UK, p. 430. ISBN 0 521 42264 7
- [11] **Pallas, P.** (1980) Water resources of the Socialist People's Libyan Arab Jamahiriya. In: *The Geology of Libya. Proceedings of the Second Symposium on the Geology of Libya*. Academic Press, London.
- [12] **Stekauerová Vlasta, Nagy V.** (2006): Course of soil layer water content in agricultural cultivated soil during years 1999 and 2000. *Cereal Research Communications*, pp. 287-290.
- [13] **The Large Farm Project in Al-Khadra Area** (2004). The Great Man-Made River Project, Socialist People Libyan Arab Jamahiriya (SPLAJ = Libya), p. 23.
- [14] **Yahia Ali Mughram, Zsarnóczai J. S.** (2008): Irrigation Possibility in Middle East and North Africa. (Öntözési lehetőségek a Közel-Keleten és Észak-Afrikában). VII. Alps-Adria Scientific Workshop on Soil-Plant Interrelations, Session: Land Use II., Stara Lesna, Slovakia, 28 April – 2 May, 2008. Edited by Hidvégi, Szilvia. Volume 36, Supplement 2008. Akadémia Kiadó. Pp. 2083-2086. (XLIV.) ISSN 0546-8191
- [15] **UNDP/FAO** (2005): Improved management of water resources for agricultural use (phase II). SYR/90/001. Damascus, Syria.



TECHNOLOGICAL FEATURES OF BIOGAS PLANTS USING MIXED MATERIALS

Author(s):

L. Tóth, J.Beke, Z. Bártfai, I. Szabó, G. Hartdégén, I. Oldal, Z. Blahunka

Affiliation:

Szent István University, Hungary, Gödöllő, 2100 Páter K. u. 1.

Email address:

toth.laszlo@gek.szie.hu, beke.janos@gek.szie.hu, bartfai.zoltan@gek.szie.hu, szabo.istvan@gek.szie.hu, oldal.istvan@gek.szie.hu, blahunka.zoltan@gek.szie.hu

Abstract

The most ecological and environmentally sensible way of the utilisation of biomass is the biogas production. The applied technologies are basically mesophile and thermophile methods, or the mixture of them. The applicable, effective energy production technology for biomass always depends on the input materials. Incineration is a wide-spread technology, mainly for the primer biomass. Fermentation is applied for those of secondary and tertiary materials that need post-treatment. Lot of materials need some kind of post treatment because of the environmental requirements (infection, ground water damage etc). Materials utilised for biogas production are no harmful for the environment, moreover the residues can be used as nutrient in the plant production technologies.

Key words

biogas, sewage sludge, fermentation, foam formation

1. Introduction

Biogas plants use a wide variety of primer materials such as whole corn silage, root crops, seed crops residues etc. that make the operation of the biogas plant more stable as their structure is

mainly constant in time. A biogas plant is quite similar to a ruminant animal. For example in the feeding of cows the so called TMR (TOTAL MIXED RATIO) system is used, that means the same composition of the feeds are used during the whole season. The stomach flora adapt to the feed and able to transform rapidly the desired quantity.

The biogas plant we studied within the frame of our research project applies different kind of input materials as a mixture. The mixing ratio also differs from the usual. In agricultural circumstances biomass is used as primer and waste from animal husbandry as sounder material is used for biogas production. When the composition of the materials is almost constant, and the material supply is continuous the operation of the biogas plant is acceptable.

The other kind of technology is based on fermentation of sewage sludge from waste water plants. The constitution of the input material is also constant, but max 10% deviation can be accepted.

In the examined technology the ratio of the sewage sludge is 55-60% (respect to the dry mat-ter). The sewage sludge as an input material comes from 8-10 settlements and the consignments differ very much from each other. 10% of the total amount of input materials is waste from food industry.

Having an up-to-date computer based control system, the electric power production of the biogas plant is approximately 2,0 MW (see Figure 1.)

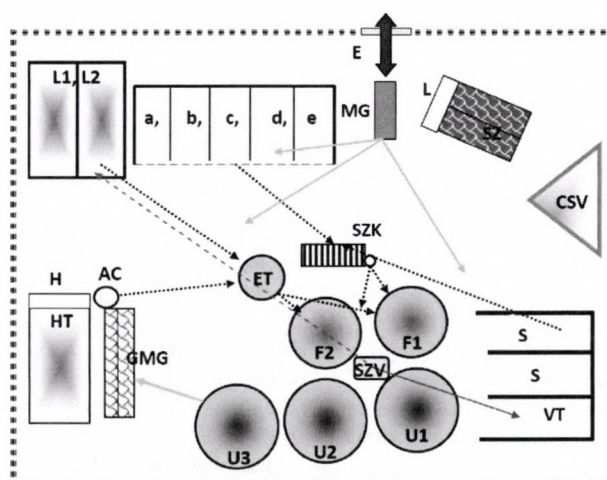

Figure 1. Scheme of the biogas plant

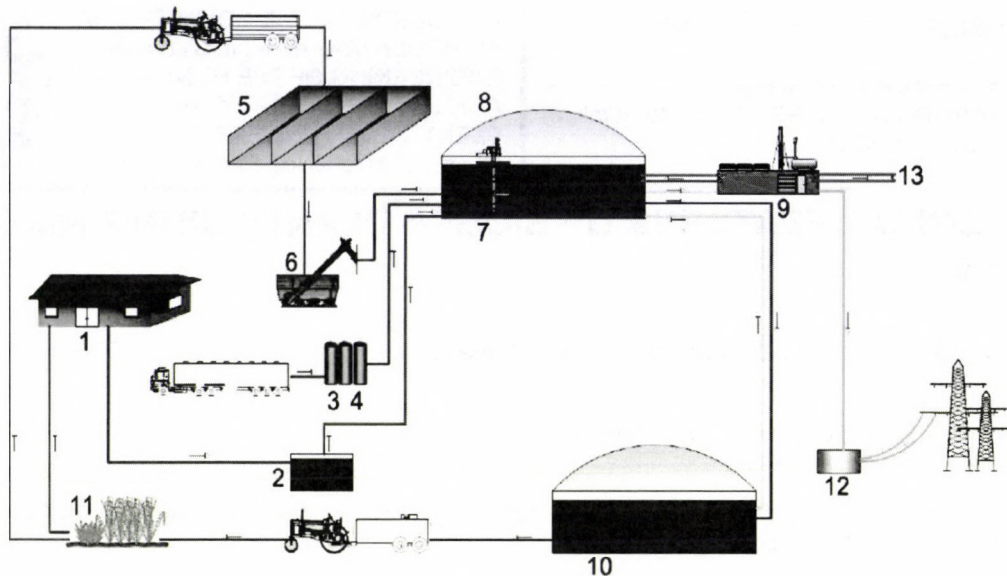

Figure 2. Biogas plant using mixed materials (Lemvig, Denmark)

1-manure, 2-liquid manure storage, 3-bio-waste storage, 4-autoclave, 5-solid matter storage, 6-chopping and feeding of solid matter, 7-biogas reactor, 8-biogas storage, 9-CHP unit, 10-substrate storage, 11-transport to field, 12-electrical transformer, 13- heat transport

According to their measurements the communities of bacteria don't have effect on foaming, meaning the indifference of the filamentous bacteria to the foam formation in the co-substrate based reactor. At the same time they confirm that filamentous bacteria, especially *Gordonia* species and *Microthrix parvicella* facilitate foaming in sewage sludge fermentation technologies.

Their articles emphasize the organic overloading and subsequently the accumulation of acetic acid as the cause of foam formation in wastewater sludge digesters (corresponding to Boe et al.).

Moreno-Andrade et al. (2004) performed a research with 10% starting value of sewage sludge that was increased continuously for 30 days. During the start up of the plant the sewage sludge was recirculated, and the pH value was set-up by lime.

According to McCarty the sewage sludge as a substrate contains all the necessary nutrients for the bacteria. 60-75% of the dry content of sewage sludge is organic material. In the mesophilic range 12-13 days are needed for the decomposition of the sewage sludge having 70% organic matter content. Under 50% of organic matter content the anaerobic decomposition is not economic.

Oláh et al. emphasize that direct charging of the organic matter into the reactor can cause the overload. In this case intensive foaming may occur within 30 minutes and the methane content of the biogas decrease as well.

The most important factors of foaming and solutions (based on literature):

- Composition of the organic matter should be constant, that helps to develop a well-balanced microbiological population (max. 4kg/day/m³ dry material).
- The best value of the C/N ratio is 15-30/1. When the level of nitrogen is low the carbon elaboration decreases-, while too much nitrogen reduces the methane production.
- Methane-producing bacteria live best under neutral to slightly alkaline conditions. Under anaerobic conditions, the pH will normally take on a value of between 7 and 7.5 (less than 6,8 can be harmful). In the presence of fermentative anaerobic organisms the optimal pH value is 4,5-6,3.
- The optimal dry matter content is 6-15 % in the case of mechanical mixing. Continuous mixing is needed in order to

maintain process stability and improving the efficiency within the digester.

- Fluctuation of the temperature reduces the methane development.
- Optimal temperature of the mesophilic bacteria is 35-40 °C.
- Dry matter content determines the load of the reactor. Quantity and the concentration together give the correct information.
- Volatile acids, the HCO₃ alkalinity and the ammonium concentration must be determined.
- Volatile acid concentration is less than 1000 mg acetic acid/l equivalent
- FOS/TAC value: 0,3-0,4 is good, but depends on the system. 0,2-0,3 is good in the second digester and the lagoon. When the value is less than 0,2 there is a lack of organic matter. Above 0,4 the organic matter content is too much.
- Air intake is needed for hydrogen sulphide oxidation (admissible content is 2-2,5% of the gas)

Applied materials for producing biogas in the investigated plant:

- corn silage
- cow manure
- liquid manure
- sewage sludge (from 12 waste water plants)
- food residues
- oil-, and fat sludge
- expired food (cold cuts, ice cream, chips)

The most important factors affecting the anaerob digestion:

- fresh inoculums
- constitution and concentration of the input material
- solids retention time, and the system load by the organic matter
- temperature, mixing and flowing compliance
- exclusion of toxic matter

In order to keep the desired efficiency, controlling some of the above mentioned factors (load, temperature, mixing) the operator is able to intervene, but changing the features of the sub-strate (chemical, microbiological constitution, toxic components) is complicated or sometimes impossible.

Discovering the real problem in the investigated plant, as a first step the constitution of the input material was examined with a

special focus on energy and ash content. At the beginning of the research project we established a target: preparing receipts to create optimal inputs for the reactors.

Determining parameters are:

- C/N
- FOS/TAC

-pH

Components are introduced in Chart 1. Components are signed Je. The desired ratio can be reached by changing the ratio of the components considering the reactor dry matter (SZA) capacity, and the load (SZA/kg).

Chart 1. Calculating table for the appropriate components ratio

Matter/Feature	Dimension	A		B		C.. etc..		$\Sigma_{inp.}$ kg	$\Sigma Je_{inp.}$ Je (desired)
		kg	Je*	kg	Je*	kg	Je*		
C/N	ratio								15-25
SZA	(%)								8-12
pH									6,5-7,8
TAC CaCO ₃	(mg/l)								13000
FOS acetic acid equivalent	(mg/l)								3000
FOS/TAC	ratio								2,1-3,0
KOI	(mg/l)								3000
NH ₃ -N	(mg/l)								1600
Phosphate	(mg/l)								10,5-12

Calculating example:

Je = feature determination e.g.: C/N

Materials weigh separately and sum total (kg)

$$\Sigma kg_{inp.} = Akg + Bkg + Ckg + \dots = \Sigma kg$$

Features separately and sum total (C/N)

$$\Sigma Je_{inp.} = (Akg * AJe + Bkg * BJe + Ckg * CJe \dots) / (Akg + Bkg + Ckg + \dots) = \Sigma Je \text{ (sum C/N)}$$

Calculation must be fulfilled for all the used input materials everytime, when feeding the reactor and always if any changes occur.

2. Discussion

Results of energetic and chemical tests of 3-3 samples (chosen from all the 12 input materials coming from different waste water plants) can be studied on figures 3-8. Dry matter content of the samples differs very much, but the C content is almost the same.

Significant difference can be found in the pH value and the C/N ratio of the samples. It is a big problem and intervention needed to make a better balance.

Although most of the samples show similar C content, the energy content differs very much. According to our results the higher the energy-, the lower the ash content, which means samples have a significant mineral content (maybe because the malfunction of the sand separator). This is undesirable because the sand content increases the dry material content and block the gas flowing. Figure 5. shows this result on two samples.

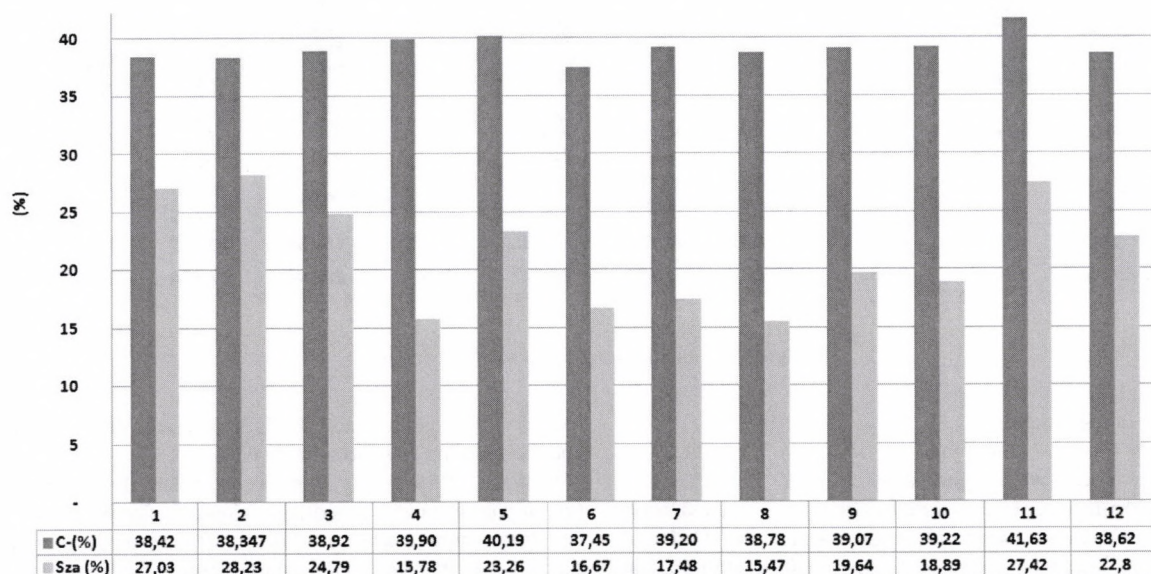

Figure 3. Dry matter content of the samples

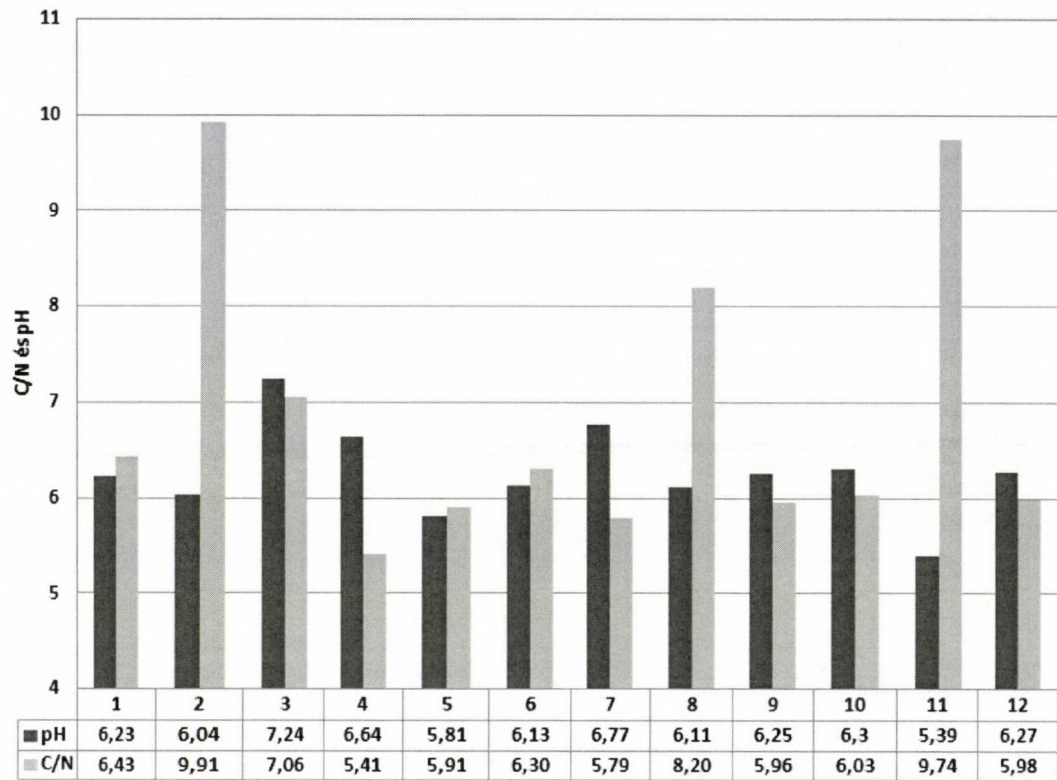

Figure 4. pH value and C/N ratio (average)

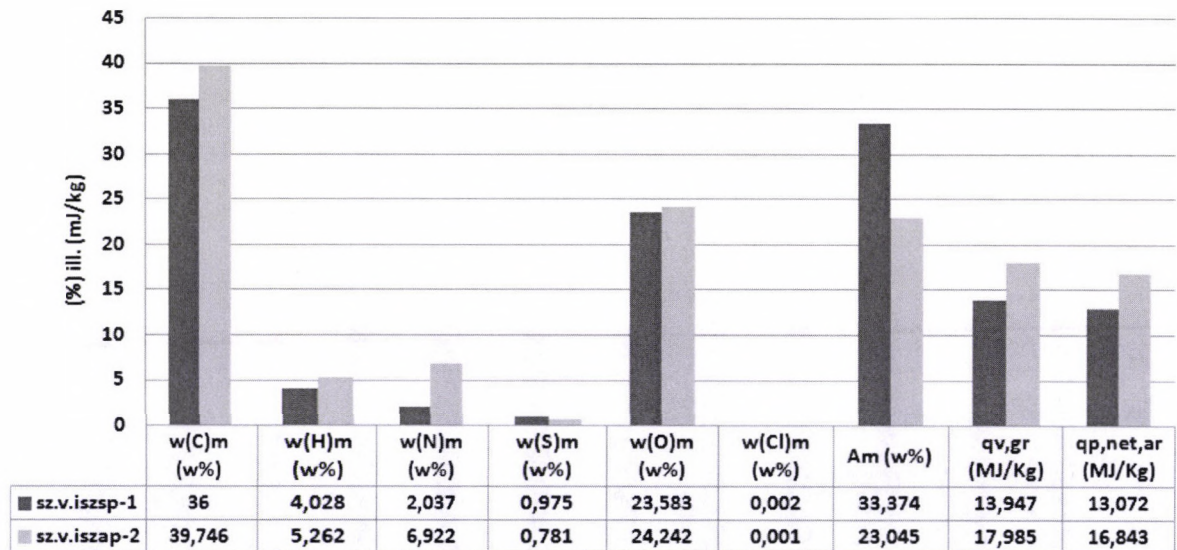

Figure 5. Constitution of two sewage sludge

Meaning of the symbols

- C-, H -, N -, S -, O -, Cl content (%)
- A_m – ash content (wet weight basis) (%)
- q_{v,gr} – calorific value (wet weight basis) (MJ/kg)
- q_{p,net,ar} – calc. calor. value (wet weight basis) (MJ/kg)

During the fermentation process C and the dry matter content decreases in the reactors. Com-pensation of the difference in the C/N ratio was carried out by manure and corn silage dosage. Because of the F2 digester operated using more sewage sludge,

the dry matter content and the C/N ratio was disadvantageous, and the foaming was more intensive there.

Features of the corn silage (brown column) and the manure (green column) can be studied in figure 7. The energy contents are almost same, but the ash content of the manure is approx. 6 times higher (because of the sand content of the manure).

Features of the other input materials were also tested. Significant difference was detected in the dry matter content, but they have more advantageous C/N ratio than the sewage sludge.

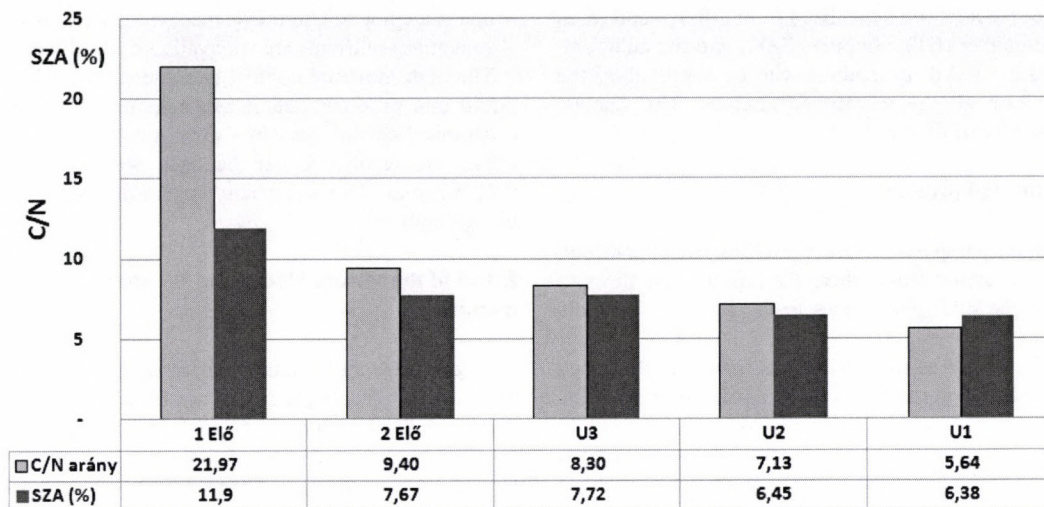

Figure 6. Changing the C/N ratio and the dry matter content in the reactors

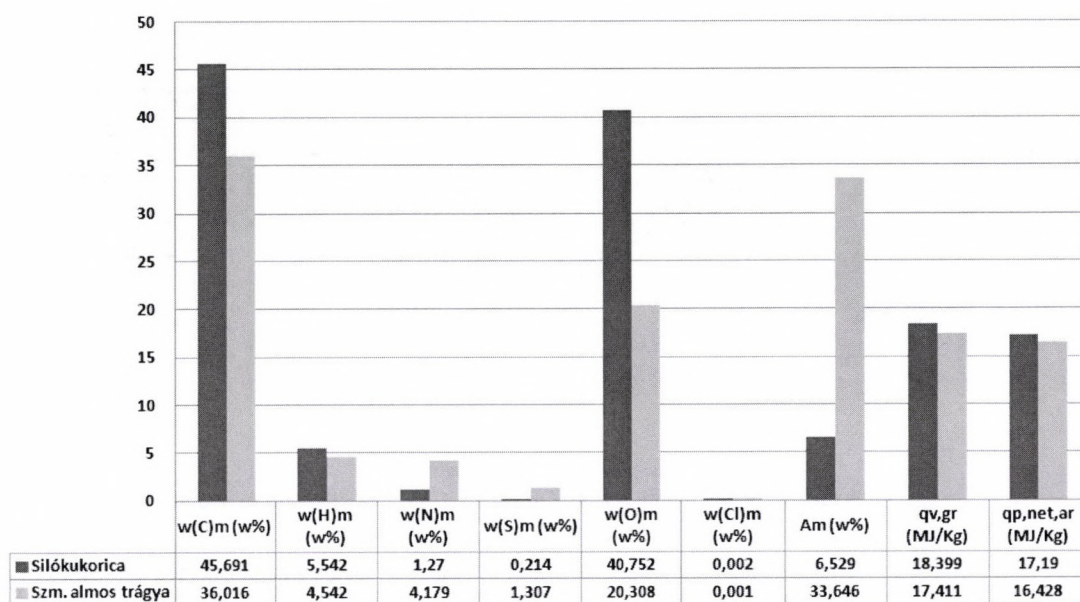

Figure 7. Features of the solids

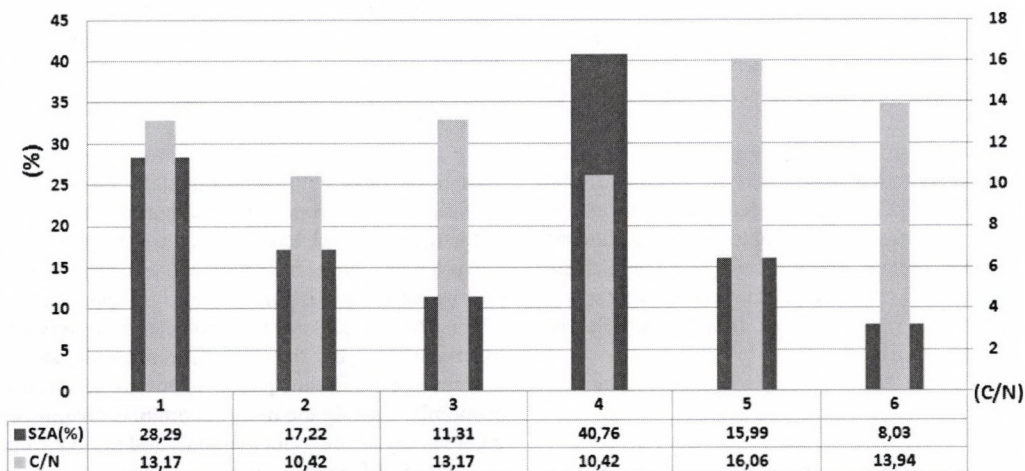

Figure 8. Features of the other materials

1) food residues, 2) liquid manure, 3) oil-, and fat sludge, 4) manure, 5) expired food (cold cuts, ice cream, chips), 6) cooked oil.

Feeding of the reactors can be realised from different sources, as the pre-storage bunker (ET), chopper (SZK) and the autoclave (AC) (see Figure 1.). All the reactors can be supplied by the central pump from all the mentioned sources. This can be important in the case of foaming.

Utilisation of the end product

With the help of the pump the substrate can flow from the second digesters to the separator, from where the liquid phase flows to the lagoon, and the solid phase goes to the concrete bunkers (VT).

Some quantity of the solid residues -as have a high energy content- can be re-used in the fermenter in order to increase the C content. The dry end product can be used as nutrient on the fields or can be composted. Also some quantity of the liquid from the lagoon can be used to help for pre-mixing (in order to control the dry content).

According to the current regulations the liquid end product (digestate) must be handled as liquid manure and may be spread out to the fields only one time a year. It must be ploughed into the soil. Problems of this procedure are:

- plants are not able to utilise the so much quantity
- sometimes nutrients are not available when plants need

The high moisture content is an advantage of spreading the liquid end product, and it can help a lot in drought. Other economical advantages can also be mentioned as digestate may substitute fertilisers, can be used well on sand soil (0,5-0,7GWh/year electric capacity ensure digestate for 1,0-1,2 ha ploughland).

Effect of the sewage sludge and the sand content of the manure

Sewage sludge and manure contain significant quantity of sand (quartz sand). As the particles are abrasive very much, the sand content is disadvantageous for the technical equipments (mainly for the chopper, and mixers). Sand stays at the bottom of the lagoon. This must be considered when using the digestate as diluent. Only precipitated digestate can be used for dilution!

The intensive abrasion makes serious problem in the chopper operation (figure 9.). Hammers wore rapidly, that cause inappropriate chopping. Fibrous material reduces the mixing efficiency that causes less gas production.

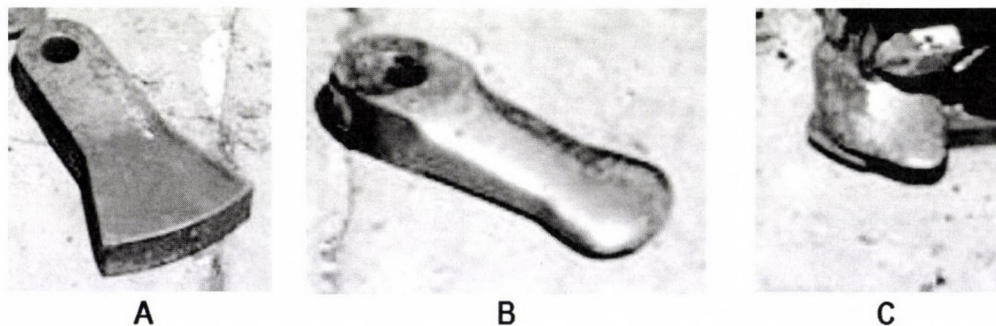

Figure 9. Abrasion of the hammers
A-original hammer, B-one month operated hammer, C-two months operated hammer

Strengthen of the edges (e.g. welding using hard metal) is suggested to avoid the intensive abrasion of the hammers.

Effect of the mixers

The digesters (F1, F2) have three same sized moveable mixers, and a bigger fix mixer. The second digesters (U1, U2, U3) have three, same sized moveable mixers. The vertical position of the smaller mixers can be changed, and they can be turned with 60 degrees from left to right.

Mixers play an important role in homogenisation. Optimal streamline inside the reactors supports the adequate heat exchange for the heating pipeline that is needed for ensuring the homogeneous reactor temperature. According to our monitoring the mixing process is inappropriate. Finding the optimal adjustment of the mixers modelling and simulation of the mixing process was performed. 135 variations were analysed. In a next article, we report on the modeling of mixing.

3. Results

During the 5 months research project our effort oriented to find the optimal feeding of the reactors. Ad hoc breakdowns of the system and sometimes stoppages of the needed input material supply resulted unwanted delays.

Application of the simulation resulted moderated foaming, and the number of the malfunctions of the system reduced. The specific gas production, relative to the input material increased (see Chart 2.). During three months the electric capacity value grown from 61,2 % to 68,7 %.

This proves our targets and the benefits of the research work, that would be sensible to continue in order to optimise the applied technology.

4. Summary

This article dealt with an operational segment of a biogas plant. As far as we can prognosticate biogas plants will be wide spread in the near future in Hungary as the concept is supported by the Government. Furthermore the concept of settling biogas plants near by wastewater treatment plants is supported by the European Union. Biogas plant can be established in the area of a wastewater treatment plant, but the idea of serving a biogas plant by at least 2-3 sewage treatment plants seems to be more effective and economic. Usually the most important problems derive from the great variety of the input materials and the very much difference in content of them. Foaming is maybe the most serious malfunction. Operation without any troublesome can be observed mainly where recipes are used in the technology based on laboratory tests, focusing all the critical parameters and features

of the input materials. If feeding is consistent, then the specific gas production (m³ gas/kg input material) increases. In Hungary the annual sewage production is 500.000 t, and only 20% is utilised for biogas production. A significant amount is sent to landfills, although the anaerobic digestion is the best solution

considering the ecological and economical aspect. The end-products of the biogas plants are energy (electric and heat as well) and good quality manure that can be used well in the plant production technologies.

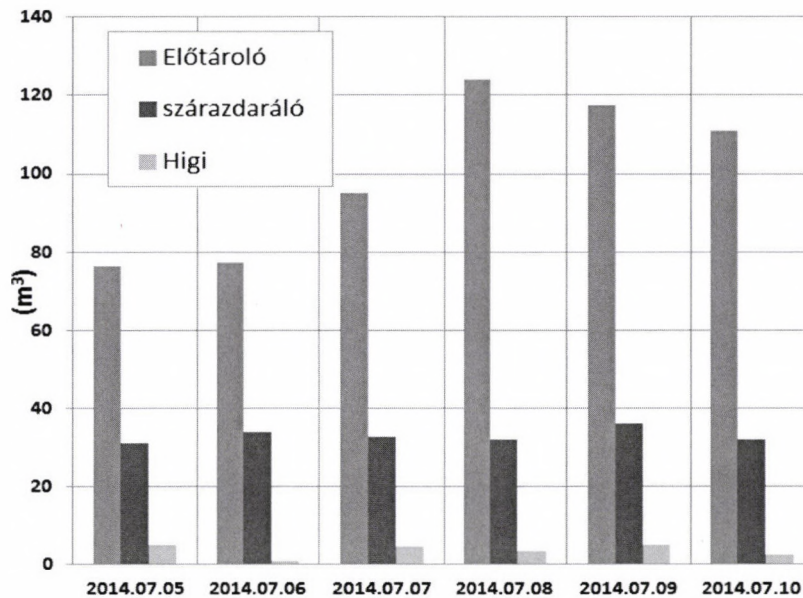

Figure 10. Fed materials
(blue-pre-storage, brown-solid chopper, green-autoclave)

Chart 2. Electric power capacity of the system

Rated capacity MWh/month	Effective capacity (MWh/month)	Calculated cap. from inputs** (MWh/month)	Calculated cap. from inputs * MWh/month)
1480,56	592,2	1017,6	916,2
100%	40,0%	68,7%	61,2%

References

- [1] A. Zehndorf, L. Moeller, K. Görsch, V. Beer. **Bernburg**, 2010 Schaumbildung in Biogasanlagen, Hemholtz, Zentrum für Umweltforschung UFZ, 30. November
- [2] **Bayerische Landesanstalt für Landwirtschaft (LfL)**. (2006). Biogastechnologie zur umweltverträglichen Flüssigmistverwertung und Energiegewinnung in Wasserschutzgebieten, (<http://www.LfL.bayern.de/publikationen/>)
- [3] **Esteves S- Miltner M-Fletch S**: Folyamatos ellenőrzési útmutató a biogáz és biometán üzemek megfelelő működtetéséhez
- Gruber, W. (2007). Biogasanlagen in der Landwirtschaft. Aid infodienst Verbraucher-schutz, Ernährung, Landwirtschaft e.V. Bonn. 1453.
- [4] **Kardos L.** A szennyvíztelepi biogáz termelő fermentációs folyamatok nyomon követése kémiai és biokémiai módszerekkel PhD dolgozat, ELTE, 2012
- [5] **Koppe, P. - Stozek, A. - Neitzel, V.**: Municipal waste eater and sewage sludge in Rehm, H. J. and Reed G: Biotechnology, Volume. 11a. Environmental Process, p. 337-

- [6] **Kougias P. G., Boe K., Thong S. O, Kristensen L. A. and Angelidaki I.**: Anaerobic digestion foaming in full-scale biogas plants: a survey on causes and solutions ISWA publishing 2014,
- [7] **Kovács at al (2003)**: A szennyvíziszap-kezelés és hasznosítás jogi, gazdasági, műszaki, környezetegészségügyi feltételrendszere
<http://www.emla.hu/alapitvany/02-03/szviszap.pdf>
- [8] **Moreno-Andrade I., Buitron G.** (2004): Influence of the origin of the inoculum on the anaerobic biodegradability test. Water Sci. and Technol. Vol. 49. No. 1.
- [9] **Noike T., Li Y.Y.** (1989): State of the art on anaerobic bacteria for wastewater treatment. 2. Acid producing bacteria. In: Study on Anaerobic Wastewater Treatment. Japan Society of Civil Engineers. To-kyo
- [10] **Oláh J- Palkó Gy- Szilágyi M- Barabás Gy- Gyarmati I- Tuba L**: Rothasztók üzemeltetése
http://statex.hu/cikkek/Uzemeles_szerkesztett_5_.pdf
- [11] **Öllös G-Oláh J-Palkó Gy**: Rothasztás MAVÍZ, 2010
- [12] **Petis, M.** (2008). Biogáz hasznosítása. Energiapolitika 2000 Társulat. Ener-giapolitikai Hétfő Esték. 2008.02.11. Budapest.

[13] **Tamás J, Blaskó L** (2008) Environmental management, Debreceni Egyetem a TÁMOP 4.1.2 pályázat

[14] <http://www.fvmmi.hu/file/document/hir/monitoringmagyar.pdf>

[15] http://www.tankonyvtar.hu/hu/tartalom/tamop425/0032_kornyezett_echnologia/ch06s11.html

[16]

http://www.researchgate.net/publication/260381931_Anaerobic_digestion_foaming_in_full-scale_biogas_plants_a_survey_on_causes_and_solutions

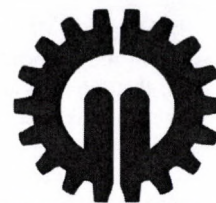

COMPARISON OF POSSIBLE GREENHOUSE ENERGY SOURCES

Author(s):

J. Nagygal¹, L. Tóth¹, J. Beke¹, I. Szabó²

Affiliation:

Szent István University, Hungary, 2100 Gödöllő, Páter K. u. 1.

¹Institute of Process Engineering, ²Institute of Mechanics and Machinery

Email address:

nagygj@arpad.hu, toth.laszlo@gek.szie.hu, beke.janos@gek.szie.hu, szabo.istvan@gek.szie.hu

Abstract

The most prominent cost of a greenhouse is the energy consumption, meaning that when planning systems, analysing the energy-efficiency of the method to be used, and its results is one of the most important factors. The heat resource depends on the heating system, and indirectly on the technological implementation of production. Overall, the most cost-effective solution with the least amount of losses can be one specific course of planning, while another can be the performance and the relative age of the system, which would mean a higher cost. We can't disregard planning for the future changes in resource price (if there is a change).

Keywords

greenhouse, heating energy, greenhouses specific energy consumption

1. Introduction

Producing energy supply of greenhouses, and usable energy resources

Nowadays, building greenhouses is at its renaissance. The modern, high atmosphere greenhouses create a huge advancement for the sector due to the most recent building techniques, and the most proficient engineering solutions. In Hungary, greenhouses can only operate with a profit for a limited time interval, in the

era of borderless, open trade. This time interval of a few months is between the rush of unheated greenhouses of South-western Europe and Northern Africa, and the rush of domestic open-air plant production and unheated greenhouses. This technically falls between December-January and May [3, 14, 17, 18]. These months cover most of the heating season of winter, meaning plant production in winter isn't possible without heating the greenhouses. We have a multitude of possible energy sources to cover this, but domestic practice and the development resources of horticultures, not to mention their low profitability, caused only a few to be widespread. [19].

2. Source and method

Energy sources in widest use [25]:

Heat production using combustion:

- Firewood, wood chips [13]
- Pelletized heat sources
- Coal
- Natural gas or LP gas
- Fuel oil / Crude oil

Without combustion [9, 20]:

- Heat withdrawal using thermal water.

Using supporting energy sources (electric energy, natural gas, pyrolysis gas) using environmental heat [15, 16,]:

- Heat-pumps (air-air, ground-air, or wastewater-air)

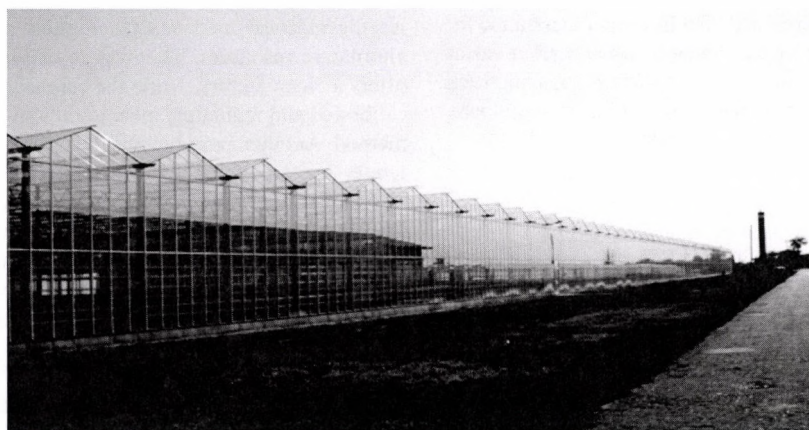

Figure 1. Modern, high atmosphere greenhouse in Southern Hungary

In Hungary, all energy resources are available, and the best solution fully depends on how economic its use is [11, 21]. We hope that the next introductions help with choosing a solution, seeing that the data is double-checked, and up-to-date, as much as possible.

The life expectancy of the machinery is not set in stone, but during the calculations, we found it rational to use a 15 year lifecycle. The requirement was set to be 1600 kW, since this is relatively close to the planned energy requirements of greenhouses with huge internal space, equipped with double-glass plating, greenhouse shades and ground-, vegetation- and shoot-tip heating, with a 5-5.5 m furrow height, and 10.000 m² floor area. If we consider the weather conditions of the last few years, the heat requirement of an intensively cultivated 1,0ha greenhouse is around 300-320 kWh/m² each year (Figure 1.).

Defining heat requirement

The widely used equation for heat requirement is as follows [6, 22]:

$$Q = K' (t_b - t_k) F_{\dot{u}}$$

where:

Q = amount of heat needed each hour (kJ/h)
 K' = „heat consumption“ coefficient (kJ/m² h °C)
 t_b - t_k = Δt = difference between outer and inner heat requirement (°C)
 F_ü = the surface area of the greenhouse in question (m²)

Firewood, wood chips

If we look at the heating of greenhouses in the last few years, wood has become more and more widely used. The wood here means mostly the wood, and its scobs from deciduous forests, and wood unusable for either building or crafting, and the trimmings and liber of wood used in the building industry [5, 13, 24].

Pros:

Easily acquirable, both in log and in wood chip forms. Its price didn't have a substantial change in recent years, calculations with heating costs are therefore easier, meaning we can do an easily definable cost-calculation. The price of furnaces is usually cost-accomodating, their build is relatively simple, and can be found in a wide range on markets. In recent years, industrial wood- and chip furnaces can abide by nature conservation regulations due to recent developments appearing on the market. The resources are essentially renewable sources, given the defined logging circumstances, meaning their subsidy may be imminent [4].

Cons:

May have costs and risks due to the usually huge transport distances. The appearance of tolls make its transportation even more expensive. The mass/volume and calorific value/volume ratios are low. Obtaining dry resource at a low price is rare, since in the last 10 years, using firewood also lives its renaissance for the general populace, meaning the demand on the market varies by time. This can be lessened with importing logs in truck volume. Its effective combustion in a furnace is hard to automate, due to its inherent need for human overseeing.

Pelletized material

Became more popular in recent years. Fibrous material made using high pressure, which is coagulated by either an outside coagulant, or its own material. Pelletized material can range from a few millimetres to a few centimetres, depending on what pelletizing technology was used to create it.

Pros:

Pelletized material can be easily acquired, and in many quality variations, depending on calorific volume. The standardized size

(length and girth) makes its combustion easily automatable. Its price depends on materials used, and relatively stable, if we look at recent prices, without bigger deviations, meaning the cost of heating is easily calculated. The prices of furnaces, similar to wood furnaces, is relatively favourable. Pelletized material is treated as a renewable source. Due to the production technology, its hydration is low.

Cons:

Making pelletized material demands high amounts of energy, mostly due to the performance and high consumption of pelletizing machinery, which makes an impact on the energy balance of utilization. Its transport fees are high, since it's mostly vehicular transport, which requires robust vehicles due to its high capacity requirement. Since the pelletized material needed for the entire production season must also be stored, the loading and storehouse costs are further problems. Some base materials make the nature conservation regulations hard to follow, and the sludge in the furnaces may cause malfunctions.

Lignite, coal

Pros:

Due to the developments of the market in recent decades, the coal reserves can be called "abundant". According to the plans of the government, we can expect the re-opening of multiple coalmines. Thanks to the research of recent years, and the appearance of so-called "clean" coal technologies, the nature conservation level, and the assessment of efficiency took a turn for the better.

Its price is stabile, since the market is more focused on supply, meaning the acquisition doesn't pose a problem. Its transport fees can be lowered substantially due to the classic railway-transport. The price of furnaces is extremely favourable in its category.

Cons:

If the area of usage is far from the railway, the vehicular transport will add to the costs of usage. Automating is hard, technically requires human intervention at all times, therefore, the needs of actual labour are high in comparison. Heating can't be regulated well, reaction to changing heat needs comes with a relatively low hysteresis, meaning buffer heat capacitors are needed for the system to be applicable to greenhouse heating.

Natural gas or LP gas

Natural gas is a mixture of carbon-hydrogen-based gases, and is highly flammable. Its main elements are methane, ethane, propane, and butane. The canned gas, or LP gas is fluidic gas which mainly consists of either propane, butane, or a propane-butane mixture.

Pros:

Since the chemical composition of fluidic gas is relatively simple, it's the cleanest, and has the highest calorific volume of all alternative resources. The system can be automated perfectly, offers a clean factory, while the furnaces are modern and easily calibrated and regulated, meaning it's an overall flexible heating method. Another extra benefit in case of greenhouses during the winter season is the carbon-dioxide collection, which can be rerouted to the plants, which lowers costs and has a positive impact on production yield. The close availability of piped gas makes connecting to the heat source easy, and simplifies the planning-implementation procedure. The installation of LP gas can be solved with a low cost, its planning and implementation is a simple task.

Cons:

The purchase and acquisition of natural and LP gas is frequently the target of the political happenings and manipulation of various countries. Since in Hungary, the first thing we have to

consider is import - due to our domestic reserves being insufficient to cover needs - it's difficult to determine the costs of the gas industry several decades ahead. In most horticultures, piped gas isn't acquirable, and the necessary building costs are huge, and if we include the licensing, the registry of easements in light of the dispersion of land rights, it seems outright impossible. The price of LP gas increased drastically in recent years, making the horticultures fully dependent on gas heating impossible to manage.

Fuel oil

Oil in itself contains a multitude of various organic compounds. These are not extracted in their clear state, but instead divided by their area of use. One of these is fuel oil.

Pros:

The system can be easily automated, and offers a clean factory if the implemented machinery is modern, the furnaces are well-developed, easily regulated, and it's an overall flexible heating method. The cost to install it is low, the price of furnaces is acceptable. The system can be booted quickly, meaning it's best used as extra (supplementary) or emergency heating.

Cons:

The global market price of oil shows quite a hectic change every now and then, meaning it's difficult to plan for decades, resulting in an also difficult cost calculation. Storing oil is in itself a hardship, and while vehicular transport is an option, transport fees are high. Also, it isn't renewable as an energy resource.

Thermal water

In Hungary, it's the most easily procurable, and easy to excavate source of soil heat. Soil heat is the inner heat of the ground, which is born mainly from the heat of radioactive isotopes, and the friction heat of convectional flow (Figure 2).



Figure 2. Thermal well with diving-pump excavation

Pros:

Thermal water adequately transports and radiates heat without any form of conversion, either in a direct, or in an indirect fashion. The operational costs of a thermal well are relatively low, in comparison to the energy excavated, meaning the heating based on thermal water is competitive. On Hungary's horticultural lands - mainly lowland - it's almost always present (Figure 3.). A locally found heat resource, needs no transport or import, does not depend on either season, time of day, or weather. The system can be automated easily, but only with a buffer tank which is the right size. The soil heat excavated is a renewable source, while the excavated water is partially renewable, depending on how the reserves refill [12, 19, 23].



Figure 3. Greenhouse plant production using thermal water heating in January

Cons:

Boring a thermal well is costly. The piping of the water, and its transportation to the area of usage sometimes requires the installation of high-level infrastructure. It's not available everywhere, and the water is not always adequate for excavation. Water placement is a problem which has been resurfacing for decades - placement above ground, or refilling? The system's long-term operation, and the maintenance of the wells can only be done with a slow hysteresis, otherwise, malfunction is inevitable. The basic requirement of this method is the big buffer tank, which costs a lot to install. Excavation and wiring requires electricity. The placement above ground raises enviro-protection questions in case of high salt concentration water. Similarly, refilling raises drinking water-base questions, when it's done to a layer more shallow than the source.

Heat-pump

Heat-pumps are machines - caloric machines - that are used to extract heat from a lower temperature environment, and transport it to a higher temperature area. The goal of its usage is to manage heat energy, during which cooling energy can be used for heating purposes (f.e. water-heating), and the heat of the environment can be exploited. Heat-pumps are essentially cooling machines, which implement the transmitted heat on the hot side, instead of the extracted heat on the cool side [8, 1].

Pros:

The machinery went through a drastic evolution in the last century, and has a much better efficiency rate. In terms of drive, it can be either electric, or engine-driven. The mass used for heat extraction can be air, ground (probe or collector), and subterranean water, or even leachate. In itself, it can be used as either main or supplementary heating. It's easy to control, and using well-defined heat levels, can be very efficient. When using supplementary energy, it generates the heat return three- to four-fold. It's a dependable machine, and requires light maintenance.

Cons:

Installing and maintaining it requires a high level of attention and professional skill. In case of a high requirement of heat energy, we have to calculate with high electricity needs. The useful medium-temperature is limited efficiency-wise. Installing it is relatively expensive.

3. Economic analysis

Installation prices of systems, and prices of specific energy

Since the heating requirement can vary between landscapes due to external effects, the values in Charts 1, 2, and 3 can't be used universally for each area, and therefore offer comparisons.

In Chart 2, we used average prices for industrial users in Hungary when we defined the prices of energy sources. When we defined the prices of the machinery, we aimed to select the ones with high quality, and good price/performance ratio. Since we can find the products of many manufacturers on the market, from cheap to premium categories at that, we selected the prices of a Hungarian manufacturer which has both a marketing- and a service chain. We used the price of a Hungarian well-borer as a basis for thermal well-boring, who has references.

During the calculation of operation costs, we also included the taxes and fines that come with the system's usage. We chose a legal, approved, and completely regulation-abiding operation methods for each energy production method. Prices include the enviro-protection and enviro-pressure fees as well. At this point, we have to resolve a contradiction. Some of the enviro-protection

fees in Hungary are fines by default, while in Western-European practice, activities which are fined must be discontinued. This is the reason that our naming could prove misleading in international comparison, it may raise questions, and cause conflicts, since we count an enviro-pressure fine a tax-like cost. In Hungary, winter plant production means a 30 Co heat level (Δt). In Hungary, winter plant production means a 30 Co heat level (Δt). The growing costs of fossilized energy resources result in geothermal energy with efficient use becoming more competitive for winter heating.

In the end, we defined the costs of each system at 1600kW heat performance requirement using the data from designers and operators, and the offers seen on the internet (Chart 1). We calculated the fuel prices similarly (Chart 2).

Chart 1. Install costs of systems

	Install cost	Life expectancy	Annual cost derived from life expectancy
	[HUF]	[year]	[HUF/year]
Firewood boiler	26 500 000	20	1 325 000
Pellet boiler	25 000 000	15	1 666 667
Lignite boiler	15 000 000	20	750 000
Coal boiler	15 000 000	20	750 000
Gas boiler	7 500 000	25	300 000
Oil boiler	18 000 000	20	900 000
Thermal well	145 000 000	40	3 625 000
Heat-pump (electric)	128 000 000	25	5 120 000

Chart 2. Unit price and actual energy which can be extracted

	Calorific value and energy by unit	Price of resource by unit	Efficiency of transformation	Actual energy extracted
Firewood	4,0-4,4 kWh/kg	45 HUF/kg	75%	3-3,3 kWh/kg
Pellet	5 kWh/kg	75 HUF/kg	75%	3,75 kWh/kg
Lignite	5,6 kWh/kg	54 HUF/kg	85%	4,76 kWh/kg
Coal	8,2 kWh/kg	63 HUF/kg	85%	6,97 kWh/kg
Gas	9,7-12,5 kWh/m ³	135 HUF/m ³	94%	9,12 - 11,75 kWh/m ³
Oil	11,1 kWh/kg	330 HUF/kg	92%	10,2 kWh/kg
Thermal water	0,06 kWh/kg (dt=85/30)	0,0247 HUF/kg	None	None
Heat-pump (air)	1 kWh/kWh	35-45 HUF/kWh	COP 3,5-4	3,5-4,0 kWh/kWh
Heat-pump (soil)	1 kWh/kWh	35-45 HUF/kWh	COP 5-6	5-6 kWh/kWh

Chart 3. Specific cost, and annual energy cost

	Annual cost for the system's return in 15 years	1 kWh heat's resource cost	Annual energy cost (resource + machinery) for a return in 15 years
	[HUF]	[HUF/kWh]	[HUF/year]
Firewood boiler	1 767 000	15	88 167 000
Pellet boiler	1 667 000	20	116 867 000
Lignite boiler	1 000 000	11,3	66 318 400
Coal boiler	1 000 000	9	53 012 800
Gas boiler	500 000	14,8	85 748 000
Oil boiler	1 200 000	32,4	187 536 000
Thermal well	9 667 000	0,4	12 028 600
Heat-pump (electric)	8 534 000	12,8	82 262 000

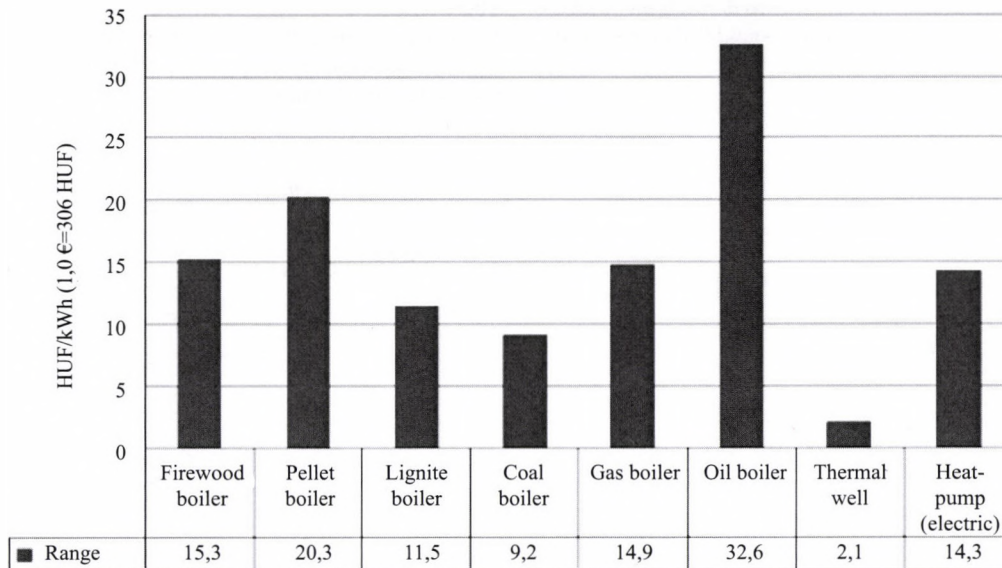

Figure 4. The total cost of 1,0kWh heat for the system's return in 15 years.

As we can see on the data of the diagram (Illustration 2), the most cost-efficient is the thermal well heating system, followed by the coal- and lignite heating systems, and the heat-pump system is only fourth. The calculations are correct for the given situation, but the heat-pump systems have further benefits, which we will introduce later on. Before we elaborate, we have to mention that the thermal water system is the simplest type (see: Illustration 1, var. A).

4. Results and discussion

Thermal water system, and its heat-pumping

As we already mentioned, the above ground placement of thermal water (Figure 5, and 6. var. B) raises enviro-protection concerns due to its high concentration of salt (which is the reason it's subjected to an enviro-pressure fine). The refilling into thermal wells (Illustration 6. var. B) raises drinking water-base problems, in case of more shallow layers. However, in spite of this, using it is necessary for sustainability reasons. Another option is to extract the thermal energy from the high-enthalpy fluid before refilling it (Figure 6. var. C) [1, 2].

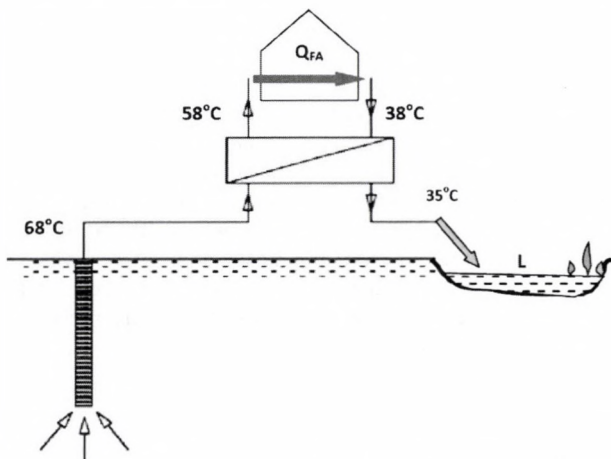

Figure 5. The traditional method of using thermal (L = lake or river)

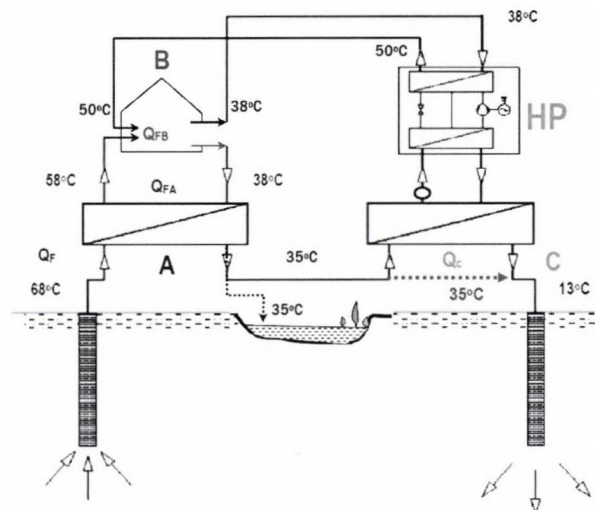

Figure 6. Usage options of thermal water

- A = Direct heating using thermal water right from the source, and re-routing the cooled (25-35 °C) water to a resting lake, or river after intensive dilution
- B = Leading thermal water right from the source into a heat-changer (QFA) and refilling the water cooled due to extracted heat (~35-40 °C)
- C = Leading thermal water right from the source into a heat-changer (QFA) and leading the water cooled due to extracted heat (~35-40 °C) into another heat-changer (Qc), heat-pumping it, then refilling the cooled water (10-13 Co), and re-routing the heat into the heating system

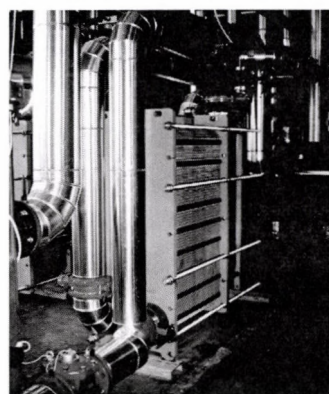

Figure 7. Heat changers before the heating circulation

The heat extractable using the heat-pumps depends on the mass flow (Figure 7.), and the ΔT (in- and outbound fluid temperature difference):

A

$$Q_{FA} = \dot{m}c(T_{68} - T_{35}) \quad [\text{kW}]$$

B

$$Q_{FB} = \dot{m}c(T_{50} - T_{38}) \quad [\text{kW}]$$

C (using heat pump)

$$Q_{FC} = \dot{m}c(T_{35} - T_{13}) \frac{\varepsilon_f}{\varepsilon_f - 1} \quad [\text{kW}]$$

B and C

$$Q_{(C-B)} = Q_{FB} + Q_{FC} \quad [\text{kW}]$$

The heat extraction processes can be defined by thermodynamic methods. As an example, we use the so-called T diagram to show the thermo-dynamic average heat of the heat extracted with the heat-pump, and the temperature of regression (Figure 8). The average temperature is derived from the higher inbound, and the lower outbound temperatures. It's practically defined by the mid-temperature of the logarithm [7].

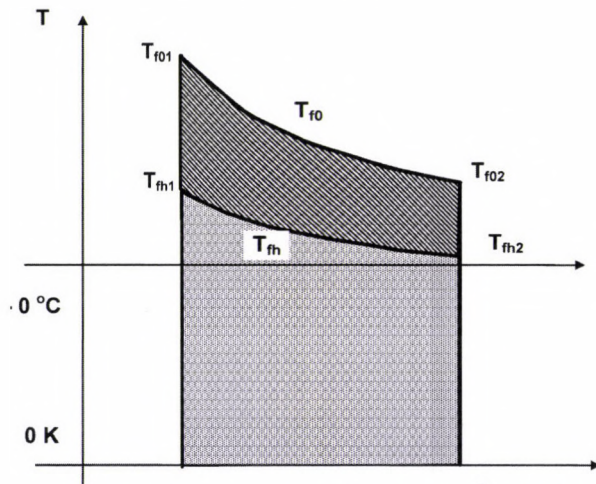

Figure 8. How the heat-pump works, shown on the T diagram

Using the thermo-dynamic average temperature, we can define the so-called "correctness factor" of heat-pumping (ε , and COP). ε is actually a hypothetical factor derived from T-S.

The average temperature of the heat delivered on the heat changer's hot side (vaporizer) and the heating side (condenser) using heat-pump:

Heat radiating side based on the T-S diagram:

$$\bar{T}_{fo} = \frac{\bar{T}_{fo1} - \bar{T}_{fo2}}{\ln \frac{\bar{T}_{fo1}}{\bar{T}_{fo2}}}$$

And the heat absorbing side:

$$\bar{T}_{fh} = \frac{\bar{T}_{fh1} - \bar{T}_{fh2}}{\ln \frac{\bar{T}_{fh1}}{\bar{T}_{fh2}}}$$

where:

T_{f01} and T_{f02} = higher* temperature point (K)

T_{fh1} and T_{fh2} = lower* temperature point (K)

*According to the illustration: 1 = higher, 2 = lower.

As for C:

$$Q_{FC} = \dot{m}c(T_{fo} - T_{fh}) \frac{\varepsilon_f}{\varepsilon_f - 1} \quad [\text{kW}]$$

And the COEFFICIENT OF PERFORMANCE (COP) factor:

$$\varepsilon_f = \frac{\bar{T}_{fo}}{\bar{T}_{fo} - \bar{T}_{fh}}$$

$$\varepsilon_f = \frac{Q_{FC}}{E_o}$$

where:

\bar{T}_{fo} = average temperature of outbound water (K),

\bar{T}_{fh} = average temperature of liquid routed to the heat-pump (K).

Also:

Q_{FC} = useful thermal energy (J),

E_o = energy used to maintain system operation (J).

The actual ε_{fv} is lower than the COP value:

$$\varepsilon_{fv} = \delta \varepsilon_f$$

Where δ is the correction factor (when used for actual calculations, according to literature, its value should be 0,4 for safety reasons).

When we talk about heat-pumping extraction, the question always pops up about how effectively the renewable energy (in our case, the geothermal heat's post-cooling) is used by the heat-pumping method. The answer appears if we compare heat-pumping with traditional (f.e. natural gas-based) heat production (Büki, 2013).

For a heat-pump, the required electricity (P) for extracting Q heat:

$$P = \frac{Q}{\varepsilon_f},$$

and its primer energy requirement, f.e. natural gas usage:

$$G_{fg} = \frac{P}{\eta_E} = \frac{Q}{\varepsilon_f \eta_E}$$

where $\varepsilon_f = Q/P$ is the COP factor of the electric heat-pump, $\eta_E = P/Q_{fg}$ is the efficiency level of producing the required electricity (P) (disregarding the losses of heat-pumping).

As we can see above, using heat-pumping before refilling or unloading the thermal water into some water body, we can acquire 60-80% of the energy that we get at the direct usage. In a proper calculation, this energy, and the operation costs of the heat-pump have to be pitted against the costs of a new well-pair, or the enviro-pressure taxes in case of unloading. In places where refilling can be done without a hitch, using the direct heat production can be competitive, but using energy from renewable sources serves sustainability best.

5. Summary

In our article we analyzed the winter heating in greenhouses and used for heating fuels and technologies on the basis of the advantages and disadvantages, and examined the capital and operating costs, and the cost of each unit of energy supply

systems. We investigated the thermal energy required for that has been used the possibility of heating water heat pump, its advantages and disadvantages

References

- [1] **Ádám B. – Tóth L.:** 2010 Fűtésre használt termálvizek visszasajtolás előtti hőszivattyúzása Mezőgazdasági Technika, Gödöllő, 52. évf. 6.sz. 2–5p. ISSN 0026 1890
- [2] **Ádám B.-Tóth L.:** 2011 Heat recovery from thermal waters used for heating by heatpump before back-injection, Synergy in the Technical Development of Agriculture and Food Industry (Synergy2011) Gödöllő, Hungary, 9–15. October 2011. 4 p. Disk ISBN: 978-963-269-250-0 <http://synergy.szie.hu/hun/news.php>
- [3] **ANSI/ASAE EP 406.4** (2003) Standard: heating, ventilation and cooling greenhouses. American Society of Agricultural Engineers, MI, USA
- [4] **Badger, P.C., and P. Fransham.** 2006. Use of mobile fast pyrolysis plants to densify biomass and reduce biomass handling costs—A preliminary assessment. Biomass Bioenergy 30:321–325.
- [5] **Bai A. et. al. :** 2002 Biomassza felhasználása. Szaktudás Kiadó Ház Budapest
- [6] **Beke J.:** 2000. Műszaki hőtan mérnököknek. Mezőgazdasági Szaktudás Kiadó, Budapest. ISBN: 963-356-317-8 pp: 294-317
- [7] **Büki G.:** 2010 Megújuló energiák hasznosítása Magyar Tudományos Akadémia Köztudományi Stratégiai Programok, Budapest, 1-79 p. ISBN 978-963-508-599-6
- [8] **Büki G.:** Megújuló energiák hasznosításának helyzete és egy jövőképe. Magyar Energetika 2010/1.
- [9] **Csikai M. – Nagygal J.:** 2007 Termálenergia-fejlesztési projektrendszer a Dél-Alföldi régióban, Projektkoncepció 2007-2013,
- [10] **Frank P. Incorporeal; David P. De Witt** (1990). Fundamentals of Heat and Mass Transfer (3rd ed.). John Wiley & Sons. p. 2. ISBN 0-471-51729-1.
- [11] **Hajdú J., Bak J., Pecznik P., Tóvári P.:** 2007 A mezőgazdasági üzemek átlagos hőigényének és effektív hőenergia termelésének meghatározásához műszaki-tervezési útmutató 78/2007. (VII. 30) FVM rendelet 2.§. e) és g) pont
- [12] **Holm A., Blodgett L., Jennejohn D. and Gawell K:** (2100) International Market Update, Geothermal Energy Association , Geothermal Energy 2010 May.
- [13] **Horváth B, Marosvölgyi B, Aranyos P, Vágvölgyi A.:** 2010 Domestic developments in the mechanisation of the energetics tree plantations MTA AMB XXXIV. Kutatási és fejlesztési Tanácskozás p. 12. (ISBN:978-963-269-165-7)
- [14] **Láng Zoltán** (1999): A zöldség-, dísznövény- és szaporítóanyag-termesztés berendezései és gépei. Mezőgazda kiadó, Budapest. ISBN 963 9239267
- [15] **Madár V., Tóth L.:** 2012 Fagázgenerátor üzemű bio-kiserőmű (CHP) és öntözőberendezés, Mezőgazdasági Technika, 09 Gödöllő
- [16] **N. S. Barman, S. Ghosh:** 2012 Gasification of biomass in a fixed bed downdraft gasifier – A realistic model including tar In: Elsevier, Bioresource Technology 107. sz., p505-511.
- [17] **Nagy Sándor - Láng Zoltán** (1999): A zöldség, dísznövény- és szaporítóanyag-termesztés berendezései és gépei. Mezőgazda Kiadó, Budapest. <http://www.hik.hu/tankonyvtar/site/books/b56/ch03.html>
- [18] **Nagygal J.:** 2005 Energy Centres in the Agriculture and Transportation EUREGA-RES, Debrecen
- [19] **Nagygal J.:** 2007 Termesztőberendezés komplex korszerűsítés az Árpád-Agrár Zrt. Kertészetében, Tanulmány, Szentes.
- [20] **Nagygal J.:** 2014 Experiences of the Geothermal Project in Szentes, Hungary IGC Freiburg, Germany
- [21] **Stróbl A.:** 2011 Tanulmány „A várható magyarországi erőműépítések fontosabb adatainak rendezése közép- és hosszú távra, valamint a MAVIR ZRt. 2011. évi forrásoldali kapacitáselemzéséhez az első, kiinduló változat összeállítása. ETV-ERŐTERV előzetes kapacitáselemzés, Budapest, Május 31, 81p.
- [22] **Szűcs M.:** Passzív napenergia-hasznosítás a mezőgazdasági építészetben, Napenergia a mezőgazdaságban /szerk. Farkas I./, Mezőgazda Kiadó, Budapest, 2003, 207-240. p.
- [23] **Thorhallsson, S. - Ragnarsson, A.** (1992): What is geothermal steam. Geothermics, 21. k. 5/6.sz. okt./dec. p. 901-915
- [24] **Tóth L. -Beke J - Sembery P. - Hajdú J.:** 2012. The role of biomass in Hungarian energy supply, Hungarian Agricultural Research, Journal of the Ministry of Rural Development Hungary, Vol. 21, Nr. 4. ISSN 1216 4826. 14-19 p.
- [25] **Tóth L. et al:** 2012. Alternatív energiaellátási rendszerek az agrárgazdaságban, Magyar Agrárkamara, Szaktudás Kiadó Ház, Budapest, ISBN 978-615-5224-22-5, 235.p 188-194pp. 208-215pp



THEORY OF COOPERATIVE AND NON-COOPERATIVE GAMES IN PRACTICE OF ENVIRONMENTAL OR SUSTAINABLE PROCESS MODELING

Author(s):

Cs. Fogarassy

Affiliation:

Szent István University, Faculty of Economics and Social Sciences,
 Institute of Regional Economics and Rural Development., 1. Péter Károly street, Gödöllő, 2100, Hungary

Email address:

fogarassy.csaba@gtk.szie.hu

Abstract

Game theory solutions may find the sufficient balance point to develop decisions in many cases, however, we usually face situations in which, due to the great number and difficulty of factors influencing the circumstances, game theory solutions show more balance points. This makes the selection of the right decision more difficult, or in a worse case, they cannot find solutions (which are difficult to write down with the use of mathematical relations) among the circumstances. Therefore, during processing the relevant literature, I emphasized the introduction of the classic and the new approach of the relations of economic value and sustainability, because the interpretation of sustainability still carries many difficulties which cause the practical implementation to be hardly achieved. Many think that the key of interpreting sustainability is to be able to conceptualize the criteria-system and requirements of sustainability through function-like relations, as well. The mathematical interpretation of sustainability factors, the introduction of sustainable economic balance or company strategies through a game theory approach, and interpreting the search for classic and sustainable economic balance points are challenges for which many theories, scientific papers, generative formulas and a great number of scientific attempts have been connected for decades now, but none of them has been fully successful.

Keywords

game theory, cooperative games, non-cooperative games, sustainable economic, Nash equilibrium, zero sum games, oligopolistic games, multi-purpose programming

1. Introduction

Economics basically states that rational behavior is based on consistent preferences. If a person's preferences satisfy some basic needs or consistence-criteria, then these preferences can correspond to a well-defined usefulness function. Therefore, rational behavior can be viewed as the maximization of the usefulness function. This leads to the fact that we can call this definition of rational behavior the usefulness theory, says Harsányi (1995a).

However, Harsányi also states that there is much evidence that this hypothesis is not valid, and that economics is rather based on

the hypothesis that the preferences of people are completely consistent (1995). Most economists view this as a useful and simplifying hypothesis, arguing that economics, which is built upon this hypothesis, can offer mostly good, even if not perfect forecasts of the machinations of the economic system.

Economic policy argues about how the happenings of economy affect the behavior of society. To prove that this is a basic part of everyday life, e.g. the fact that the average family size has been in decline in most countries in the last few decades, is well-based proof. The reason for this is that the economic pros of a larger family were greatly diminished while the cost was heightened due to the effects of urbanization and intensive technological advancement. The preference of a smaller family model and the consumption and living standards of families consisting of 3-4 people therefore took an important role in the process of optimum search (Hobson, 2012).

In order to link not only decision aspects based on economic indexes, but actual factors that have an impact on living standards to the choice preferences of various families, e.g. the criteria system of their purchases, we have to aim at creating a comparison method which can be used for many different attributes that aren't dependent on each other (Vincze, 2009). If in the course of our decisions we have to form a judgment on a system or an object based on more characteristics simultaneously and these characteristics mean a mostly controversial characteristic set, while the sorting principles being connected to this show complicated contexts, then we may turn to mathematical modeling and its software applications for help. Therefore, to start the examination of the multipurpose systems, we should assign the most important criteria. We have to accept that fact at the time of the optimization of more opportunities, that according to Axelrod (1984) we can't optimize all characteristics taken into consideration simultaneously. The simple reason for this is that the optimum of the attribute-representing objective functions usually won't correspond to the same alternative all the time.

2. Method

We can generally say about the designation of the criteria system that we cannot take each single characteristic that influences our system or the function of its examined object into consideration. That is why we have to select those that are worth the additional investigation from the essential characteristics. The various

characteristics have to be totally independent of each other. This is very important during the course of the selection in order to have no overlaps between the single criteria, since these cross characteristics may cause unnecessary examinations and a loss of time during the analysis. Therefore, during the multipurpose optimization tasks, we may have the following tasks in order for the process of the model creation, and the criteria system of the problem solution to take shape (Forgó et al., 2005):

1. Designation of criteria system (and also, major attribute sets)
2. Independence analysis of attribute sets (avoiding overlaps between attributes)
3. Designation of choice variables and parameters in attribute sets (deterministic, or stochastic – in other words, realized with some level of probability – marking)
4. Designation of binding criteria related to set (creation of sets)
5. Designation of possible criteria of the criteria system, and the number of objective functions in set (the number of objective functions is finite)
6. Search of optimum for objective functions

The general form of the multi-purpose programming task according to Molnár et. al. (2010a) is as follows (if we assume that $D(\varphi_k) = L$ and in case of any $X \in L$, $\varphi_k(X)$ is a real number):

$$\varphi_k(X) \rightarrow \max_{X \in L} \quad (k=1, 2, \dots, n)$$

X – system of choice variables

L – possible set of values for choice variables

$D(\varphi_k)$ – choice domain of function

n – number of objective functions

$\varphi_k = k$ – th objective function, in other words, the payoff function

We have to note, however, that the need for multipurpose problem solving is not the requirement of the present, since János Neumann already laid down the function-like necessities of the behaviors attached to rational decisions in 1928, and, in his work written together with Oskar Morgenstern entitled „Game Theory and economic behavior,” wrote it down in detail already in 1944 (Neumann – Morgenstern, 2007).

3. Results

Search for points of equilibrium in non-cooperative games

Game Theory fundamentally deals with the solution of multipurpose problems, that is, with so-called strategic games. Game Theory is one of the branches of mathematics with an interdisciplinary character and it primarily tries to tackle the question of what is rational behavior in situations where the possible choices of the participants influence the result of the decisions of all participants. A problem or problem solution can be called a strategic game if the decision makers may have influence on the outcome of the game between the existing conditions and the framework of rules (Mező, 2011a).

We always assume that we may characterize the outcome of the game for all players with an objective function in Game Theory solutions, in other words, the payoff function already mentioned. And for the various players (characters), the bigger the payoff function value, the more beneficial the outcome of the game is. The players' decisions, in other words, the outcome of the decisions onto the final result, are what we call the player's strategy. We know two- or multi-person variants of Game Theory solutions. The Game Theory solution is non-cooperative if the players or characters compete with each other during problem solving, while the game is obviously cooperative if cooperation takes shape between the players. The importance of searching for points of equilibrium is emphasized in Game Theory. If the search aims at the fact that, when including all players' strategies, the

benefit of one player won't change in case of him changing his strategy and none of the other players do so either, we call it the Nash equilibrium (Szidarovszky – Molnár, 1986).

The theory of the Nash equilibrium originates from John Nash, who was rewarded with a Nobel-prize for the development of the theory at the same time as János Harsányi, exactly 20 years ago. It was shown through Nash's equilibrium theory that all finite games have at least one point of equilibrium. Nash divided the optimization games into cooperative and non-cooperative types. According to his thesis, the cooperative game is the kind where cooperation between players is simply enforced. According to him, we can only talk of non-cooperative games if agreement between the players is impossible to enforce. A non-cooperative game in the case of various strategies of players can only be called stable if the so-called Nash equilibrium is present. In the case of Nash equilibrium, the strategies of the various players are the optimal replies to the others' strategies, so there aren't any players who want to break this status quo by choosing new, different cooperative strategies. The game will not be stable if it is not in the Nash equilibrium point, because there is always at least one player in this case to whom his strategy does not mean the best answer in the given situation, and therefore he will be interested in looking for a new strategy for himself (Harsányi, 1995b).

As I've already mentioned, the equilibrium situation may also be stable in case of cooperative games if one of the strategic combinations isn't in accordance with the rest of the strategies, because the strategic cooperation will sooner or later be enforced. However, in economic life we mostly face strategy creations that do not take each other into consideration and run beside each other or that do not take the multipurpose decision process or the designation of choice optimum into consideration (Molnár – Kelecsényi, 2009). From the European or economic policy practice, we have a good example for this: the bulk of strategies concerning environment protection or renewable energetic developments, since we often face a strategy creation with a contradictory direction here.

A principle is that developments with an environment protection aim have an opposite direction to that of the priority system of economic development (f. e. the program taking aim at the reduction of greenhouse gas and fossil energy use takes aim at the minimization of the intake, while the other one at the increase of a polluter energy source). A good example for this is two of the EU's main strategies: EU Low-carbon Roadmap 2050 vs. Nuclear Power in France (2014). 58 nuclear power plants operate currently in France, and additional developments are going on, while Germany just decided that by 2020, all (now 8 operating plants) of them will be shut down.

In case of cooperative games, the selected strategy may also be stable even if a strategy combination is not in Nash equilibrium but the players come to an agreement that this strategy combination will be selected. During the course of the presentation of this search dilemma for the Nash equilibrium point – in case of non-cooperative games - I lean fundamentally on István Mező's study (2011b), „Game Theory,” while if I differ from this, I'll note it separately in the description.

Definition 1:

According to the *Definition* of the Nash equilibrium:

The point of equilibrium or strategy for an n player $J = (n, S, (\varphi_i)_{i=1}^n)$ game is a point (strategic n), for which

$$\varphi_i(x_1^*, \dots, x_{i-1}^*, x_i^*, x_{i+1}^*) \geq \varphi_i(x_1^*, \dots, x_{i-1}^*, x_i, x_{i+1}^*) \quad 1.1$$

holds true for every $i=1, \dots, n$ player. The point of equilibrium is therefore called a *Nash equilibrium*. [Shortened:

$$\varphi_k(x_1^*, \dots, x_k^*, \dots, x_n^*) \geq \varphi_k(x_1^*, \dots, x_k, \dots, x_n^*).$$

where $k = 1, 2, \dots, n$].

If 1.1.'s equality is strict, then it is called a strict equality.

If we do not state anything else, we say it's the point of equilibrium is non-strict.

The i -th player can maximize his own payoff if he plays the equilibrium strategy, namely, x_i^* if all the other players do the same. We will need the following definitions to find the state of equilibrium:

Definition 2:

An n - player J game is called a constant sum if the rewards and demerits earned by the player is a constant c value, regardless of strategy.

With formula:

$$\sum_{i=0}^n \varphi_i(x) = c \quad (x \in S).$$

If $c = 0$, the game is called zero sum game.

Two-player, zero sum games are useful for demonstrating the definition of the point of equilibrium better. If we take a point of $(x_1^*, x_2^*) \in S$ equilibrium, based on (1.1)

$$\varphi_1(x_1^*, x_2^*) \geq \varphi_1(x_1, x_2^*) \quad \text{for every } x_1 \in S_1 \quad 1.2$$

and

$$\varphi_2(x_1^*, x_2^*) \geq \varphi_2(x_1^*, x_2) \quad \text{for every } x_2 \in S_2.$$

The game is zero sum, therefore:

$$\varphi_1(x_1, x_2) + \varphi_2(x_1, x_2) = 0, \quad \varphi_2(x_1, x_2) = -\varphi_1(x_1, x_2),$$

and:

$$-\varphi_1(x_1^*, x_2^*) \geq -\varphi_1(x_1^*, x_2).$$

If we rearrange the formula:

$$\varphi_1(x_1^*, x_2^*) \geq \varphi_1(x_1^*, x_2).$$

and including (1.2) inequality as well, we get:

$$\varphi_1(x_1, x_2^*) \leq \varphi_1(x_1^*, x_2^*) \leq \varphi_1(x_1^*, x_2).$$

This inequality system states that from a (x_1^*, x_2^*) point of equilibrium, if player one leaves with a strategy different from x_1^* , the payoff function can only be either lower or equal. If player two is the one who leaves, the payoff function of player one will either be greater or equal, and since the game is zero sum, this would mean that his „payment“ won't be greater.

Definition 3:

Let's look at two games, which only differ in payoff functions:

$$J = (n, S, (\varphi_i)_{i=1}^n) \quad \text{and} \quad J' = (n, S, (\varphi'_i)_{i=1}^n).$$

J and J' are called strategically equivalent, if there's a positive number, and there are b_i numbers, where $i=1, \dots, n$), that

$$\varphi'_i(x) = a\varphi_i(x) + b_i \quad \text{for every } x \in S \quad \text{and } i = (1, \dots, n).$$

The following thesis describes the obvious fact, which is also clear on the basis of simple intuition and logic that strategically equivalent games must always be played in the exact same manner.

Thesis 1:

The points of equilibrium for strategically equivalent games are the same.

Proof: Let

$$J = (n, S, (\varphi_i)_{i=1}^n) \quad \text{and} \quad J' = (n, S, (\varphi'_i)_{i=1}^n)$$

be our strategically equivalent games, and let

$$(x_1^*, \dots, x_n^*) \in S$$

be one of the points of equilibrium for game J . According to the definition for point of equilibrium (1.1), at i -th player's every $x_i \in S_i$, strategy:

$$\varphi_i(x_1^*, \dots, x_{i-1}^*, x_i, x_{i+1}^*, \dots, x_n^*) \leq \varphi_i(x_1^*, \dots, x_{i-1}^*, x_i, x_{i+1}^*, \dots, x_n^*)$$

Since J' is strategically equivalent to J , then with the constants $a > 0$ and b_i :

$$\begin{aligned} a\varphi'_i(x_1^*, \dots, x_{i-1}^*, x_i, x_{i+1}^*, \dots, x_n^*) + b_i &\leq \\ &\leq a\varphi'_i(x_1^*, \dots, x_{i-1}^*, x_i, x_{i+1}^*, \dots, x_n^*) + b_i. \end{aligned}$$

which, due to being positive results in

$$\varphi'_i(x_1^*, \dots, x_{i-1}^*, x_i, x_{i+1}^*, \dots, x_n^*) \leq \varphi'_i(x_1^*, \dots, x_{i-1}^*, x_i, x_{i+1}^*, \dots, x_n^*)$$

And this means (x_1^*, \dots, x_n^*) is a point of equilibrium for J' .

Thesis 2:

For every constant sum game, there is a zero sum game that is strategically equivalent to it, therefore having an overlap in points of equilibrium.

Proof: Let us simply subtract the constant sum from the value of payoff functions. This results in a zero sum in every possible outcome, and the new game remains strategically equivalent to the old one. Because of our previous thesis, their points of equilibrium are also the same. If we look at constant sum games, it's enough for us to only concern ourselves with the zero sum variants only. Furthermore, a two-player game is zero sum if one player wins exactly as much as the other one loses (or the opposite). Therefore:

$$\varphi_2(x_1, x_2) = -\varphi_1(x_1, x_2)$$

we can use this function, and we don't actually need a payoff function altogether, we simply use φ - instead of e.g. φ_1 .

Theoretical correspondences of finite games

If an n - player game's S_k ($k=1, 2, \dots, n$) strategy sets are finite, then we say the game is of a finite kind. Games of a finite kind can typically be either two-player or n - player, meaning more than two players. In the function-like correspondence system of games of finite kind, it can be made obvious that during the solution of multi-purpose problems, the strategic sets, in other words, the defined parameters, or criteria groups are finite, but are always more than two. Since the project development decision process of our analyzed problem, the investments related to environmental defense and renewable energetic developments is n - player ($n \geq 2$), it's advisable for us to analyze the behavior of multi-person games (Szidarovszky et al 2013). We do assume however, that the game isn't concluded in a mere moment, but at previously designated t_0, t_1, t_2, \dots times, where only one player can modify the state of the game due to a previously set consecution. This state can be depicted with a tree graph (refer to Figure 1). This process in search of optimum is quite similar to a $3 \times 3 \times 3$ Rubik's Cube's solution process alternatives, since we

decide by the cube's randomness, in other words, unsortedness, which shortest combination row (or depth level) we choose to heighten the level of sortedness, or simply, the solution of the cube in the case of layer by layer solution method (G. Nagy, 2008).

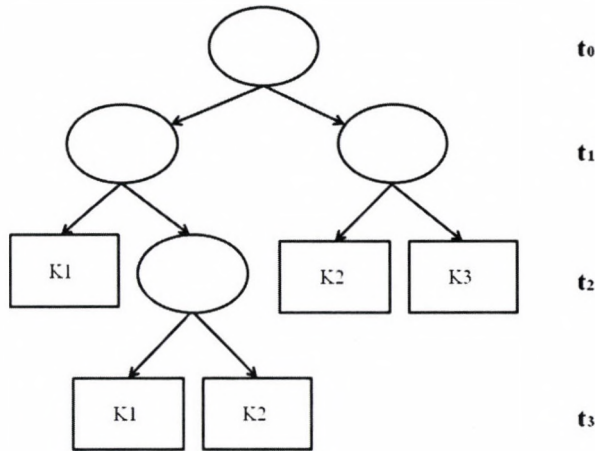

Figure 1. Decision tree graph with pre-determined times (t_0, t_1, t_2, t_3) and combination alternatives (K_1, K_2, K_3)
Source: self-made (based on MIEA, 2005)

The state of the system made by the players, in other words, the multi-purpose problem solving, can be illustrated with a problem tree, or tree graph, however, let's assume (according to Forgó et al. 1999) that:

- the tree has a starting point (state of t_0 time, which goes towards t_1, t_2, \dots, n),
- one player is assigned to the starting point and every branching point in accordance with a previously defined rule; this player can choose between the various, finite number of edges, and relocates the system's state from this edge's starting point to the conclusion point,
- every player knows the game's current progress in every t_k ($k \geq 0$) time point, including all the states of the game up to it,
- in all the conclusion points of the tree diagram, all players have a payoff function value known to them.

Furthermore, let's assume that there are no players assigned to some of the peak points of the tree graph and the progression from here happens randomly through predetermined distributions, meaning the players don't have choices, or do, but only symbolically. For the sake of uniformity, let's assign a player to these peak points as well, but their decisions are merely formal. In this case, the payoff functions of the game should be replaced with anticipatory values based on the random distributions. This game can be illustrated with a finite tree graph and is called a perfect information extensive-form game (Molnár - Szidarovszky, 1995; Molnár 1994).

Thesis 3:

Every perfect information extensive-form game that can be depicted with a tree graph has at least one point of equilibrium.

Proof: Let I mark the starting point of the tree graph, while V_1, V_2, \dots, V_M marks the conclusion points. In our tree graph's case, there is a single route leading from I to every V_k conclusion point. The length of the longest route is called the tree graph's length. We will prove the thesis with the complete induction of the game's tree graph's length, according to Molnár and Szidarovszky (2011a).

If $h(F)=0$, then the tree graph only consists of the starting point. This means that players only have a single strategy. Furthermore,

in this case, this single strategy is obviously the point of equilibrium. Let's say that $h(F) \geq 1$. Let m mark the number of edges originating from the starting point, and let U_1, U_2, \dots, U_m be the conclusion points of the edges originating from the starting point. Furthermore, let F_k ($k=1, 2, \dots, m$) mark the maximum part-graph with the U_k starting point, excluding the I peak point. It is obvious that F_k 's conclusion points are from F 's points. Let

$$\Gamma_k = (n; S_1^{(k)}, \dots, S_n^{(k)}; \varphi_1^{(k)}, \dots, \varphi_n^{(k)})$$

mark the original game narrowed to F_k , meaning that to F_k 's peak points, we assign players also assigned to them in F , and to its conclusion points, we assign the payoff function values of F .

In this case, it's obvious that $h(F_k) < h(F)$, therefore, according to our induction thesis, Γ_k games have

$$x^{(k)*} = (x_1^{(k)*}, \dots, x_n^{(k)*})$$

existing points of equilibrium. Let us say that in the game of graph F , we assigned player i_0 to the starting point.

- Let us assume that player i_0 can freely decide between the m routes originating from the starting points. In this case, it's obvious that if $i \neq i_0$ then $S_{i_0} = X_{k=1}^m S_i^{(k)}$

$$S_{i_0} = X_{k=1}^m S_i^{(k)} \times \{1, 2, \dots, m\}.$$

Therefore, player i_0 , apart from advancement in graph F_k , has to decide the advancement from the starting point as well. Let φ_{i_0} mark $(x^{(k)*})$ numbers' highest index, where the strategic n bundle obviously offers the point of equilibrium for the game, in case of Γ_k ($1 \leq k \leq m$) games' $x^{(k)*}$ points of equilibrium, supplemented by advancement from starting point I to point U_{k_0} .

- Let us assume that player i_0 randomly makes a choice at the start of the game from a pre-determined p_1, p_2, \dots, p_m probability distribution. In this case, the Cartesian product of Γ_k games' $x^{(k)*}$ points of equilibrium gives the original game's point of equilibrium. To prove this, let's say that in case of $k=1, 2, \dots, m$ and $i=1, 2, \dots, n$:

$$\varphi_i^{(k)} x^{(k)*} \geq \varphi_i^{(k)} (x_1^{(k)*}, x_i^{(k)*}, \dots, x_n^{(k)*}).$$

with arbitrary $x_i^{(k)} \in S_i^{(k)}$, multiplying the inequality by p_k and in case of $k=1, 2, \dots, m$, we obtain the inequality defining the point of equilibrium for the original game by addition.

The thesis was proven based on Molnár - Szidarovszky (2011b), who stressed during the proof that the multipurpose problem solving is primarily suitable for the solution of smaller tasks, in other words, forming short tree graphs. Here, we get games that can be depicted with zero length tree graphs, in case of which staying in their only point means the only point of equilibrium. However, the number of the short tree graphs may grow so much in case of bigger tasks that it makes searching for points of equilibrium impossible. This can be recognized with experimentation - trial and error.

Games of infinite kind - Game Theory models with one or more points of equilibrium

Games with a single point of equilibrium

The simplification of the points of equilibrium for any given game can be proven by e.g. proving the problem of one of the exact fixed point-problems, which is equivalent to the problem of equilibrium. During the proof, I basically follow Szidarovszky's logical process, while if I differ from this, I'll note it separately in the description.

A single-variable, fixed point problem usually means the solution of the $f(x) = x$ equation. It is a known fact that if f is a decreasing function of x , there can be no more than one solution.

Let's try to generalize this monotonicity criteria to a multi-dimension case. Therefore, let \mathbf{f} be a vector-variable, vector-value function, $\mathbf{f} : \mathbb{R}^n \rightarrow \mathbb{R}^n$. The following example shows that strict monotony by component still won't guarantee exactness (Szidarovszky, 1978a).

Example. Let's look at the

$$\begin{aligned} x &= -x - 2y \\ y &= -2x - y \end{aligned}$$

fixed point-problem, given by

$$\mathbf{f}(x, y) = \begin{pmatrix} -x - 2y \\ -2x - y \end{pmatrix}$$

imaging. Both components in both their variables are strictly decreasing functions, and yet there are an infinite number of fixed points:

$$y = x.$$

We can show however, that a different type of monotony is sufficient to prove the exactness of fixed points.

Definition. Let $D \subseteq \mathbb{R}^n$ be a convex set. We call an $\mathbf{f} : D \rightarrow \mathbb{R}^n$ function monotone, if for any $x, y \in D$:

$$(x - y)^T(\mathbf{f}(x) - \mathbf{f}(y)) \geq 0.$$

function \mathbf{f} is called strictly monotone, if for any $x, y \in D$ and $x \neq y$:

$$(x - y)^T(\mathbf{f}(x) - \mathbf{f}(y)) > 0.$$

We can easily see that if \mathbf{f} is monotone, the imaging cannot have two different fixed points. Let us assume in spite of this that x and y are both fixed points.

$$\begin{aligned} 0 &< (x - y)^T(x - y) = (x - y)^T(\mathbf{f}(x) - \mathbf{f}(y)) \\ &= -(x - y)^T((-\mathbf{f}(x)) - (-\mathbf{f}(y))) \leq 0, \end{aligned}$$

This is obviously a contradiction.

We can easily check the monotony of the imaging, as shown by the next thesis:

Thesis. Let $D \subseteq \mathbb{R}^n$ be a convex set and $\mathbf{f} : D \rightarrow \mathbb{R}^n$ function continuously differentiable. Let $J(x)$ mark \mathbf{f} 's Jacobi matrix at point x .

- a) If $J(x) + J^T(x)$ is positive semi-definite in all $x \in D$ points, \mathbf{f} is monotone,
- b) If $J(x) + J^T(x)$ is positive definite in all $x \in D$ points, \mathbf{f} is strictly monotone.

Proof.

For a fixed $x, y \in D$, let's introduce the

$$g(t) = \mathbf{f}(y + t(x - y))$$

scalar variable function. Obviously

$$g(0) = \mathbf{f}(y) \text{ and } g(1) = \mathbf{f}(x),$$

therefore

$$\mathbf{f}(x) - \mathbf{f}(y) = \int_0^1 J(y + t(x - y)) (x - y) dt.$$

Let's multiply both sides from the left by the $(x - y)^T$ linear vector, and we get:

$$\begin{aligned} (x - y)^T(\mathbf{f}(x) - \mathbf{f}(y)) &= \int_0^1 (x - y)^T J(y + t(x - y)) (x - y) dt \\ &= \frac{1}{2} \int_0^1 (x - y)^T \{ J(y + t(x - y)) + J^T(y + t(x - y)) \} (x - y) dt \end{aligned}$$

In the previous step, we used the fact that for any given $u \in D \subseteq \mathbb{R}^n$ vector and $n \times n$ type J matrix:

$$u^T J u = u^T J^T u,$$

since both sides are scalar, and each other's transposes. If $J + J^T$ is positive semi-definite, the right side isn't negative, and if it's positive definite, then it's positive, respectively. Having precise knowledge about imaging is an absolute necessity to use the results above, which isn't always possible, due to the need for knowledge on solving optimum-problems. This is why results which are based on the attributes of strategic sets and payoff functions are very important (Molnár – Szidarovszky, 2011c; Mészáros, 2005).

Two-player games of an infinite kind: biomass-management

Let's take a builder depot as an example, which is in contract with a logging firm for firewood (biomass) supply. For the sake of simplicity, I'll only include one type of firewood, meaning one type of product. According to our hypothesis, the distribution of the purchases arriving to the builder depot is exponential, meaning it's a question of incoming needs per timeframe (Molnár – Szidarovszky, 1995):

$$g(x) = ae^{-ax} \quad (a > 0, x > 0).$$

To understand the example, we will be using the following: a_1 is the total profit from selling one unit of product, meaning firewood, if it supplies from its own stock. a_2 will be the total profit of the builder depot, which comes from purchased firewood ($a_2 < a_1$). b_1 will be the deposit cost of the builder depot per unit. b_2 will be the logging firm's deposit cost per unit.

The strategies of both the builder depot and the logging firm can be described by one number: the size of their stock. If y marks the builder depot's stock while z marks that of the logging firm, then the builder depot's anticipatory profit is as follows:

$$\begin{aligned} f_1(y, z) &= a_1 \int_0^y xg(x)dx + \int_y^{y+z} [a_1 y + a_2(x - y)]g(x)dx + \\ &+ \int_{y+z}^{\infty} (a_1 y + a_2 z)g(x)dx - b_1 y \end{aligned}$$

The first part of the formula refers to when need is lower than y , then the building depot can cover it from its own stock. In this case, his profit per unit is a_1 . The second part refers to when $y+z \geq x \geq y$. In this case, the building depot covers y amount from its own stock, and the remaining $x - y$ need is covered by purchase. The third part refers to when $x > y + z$, where the building depot can't cover all needs from its own stock, therefore, it satisfies y from its own stock, and z from purchase, namely the logging company's stock. The fourth part of the formula refers to the cost of deposit. Based on the same correlation, the anticipatory profit of the logging firm is as follows:

$$f_2(y, z) = a_3 \int_y^{y+z} (x - y)g(x)dx + \int_{y+z}^{\infty} a_3 z g(x)dx - b_2 z$$

With this, I defined a two-person game of infinite kind. If we propose that y 's permissive values are y_1, y_2, \dots, y_{m_1} and z 's permissive values are z_1, z_2, \dots, z_{m_2} , while we allow mixed strategies as well, then we have a bimatrix game (Molnár et al., 2010b):

$$\begin{aligned} A &= f_1((y_i, z_j))_{i,j=1}^{m_1, m_2} \\ B &= f_2((y_i, z_j))_{i,j=1}^{m_1, m_2} \end{aligned}$$

Theory of cooperative games

Primarily those market players and companies that can be defined well on the market can already apply Game Theory solutions well in the present practice. Game Theory mathematics, meaning the selection of suitable strategies supported by numbers, may happen in an exact manner. What currently doesn't generally apply to the

selection of appropriate strategies is the practice of cooperative aim or strategic choice. The sustainability concepts make it unambiguous that a production/consumption goal system can be planned long-term if the use of resources is planned and in a synchronized manner. Sustainable development may not be realized without this cooperation. The cooperative attribute and the fact that market players form coalitions provides a new approach to the Game Theory approach, as well. This doesn't necessarily mean that the interests of players are the same regarding e.g. the distribution of costs, but during the cooperation, it is compulsory to abide by a collectively defined criteria system (Hardin, 1968).

During cooperative strategies, the players or market players have the natural aim of raising their profits by giving up on their autonomy partially or completely (Solymosi, 2009). By this method, a given group of players or all players cooperate with each other and perhaps form coalitions or even a single coalition. The natural requirement of the cooperation is that the participating players or market players must have a higher share of profits compared to those who do not take part in cooperation at all. In this case, the goal won't be the increase of personal profits, but the maximization of the cooperation's profits. This aim completes the criteria of sustainability, in other words, sustainable development, or economy's weak sustainability (Molnár – Kelecsényi, 2009).

Cooperative games will be defined with the following descriptions. $N = \{1, \dots, n\}$ is the set of players for which a given S subset is commonly known as a coalition: $S \subseteq N$. Let S be the set of subsets or the set of coalitions. The N base set is called complete coalition (Szidarovszky, 1978b).

Conflict alleviation methods

Conflict alleviation methods are one of the favored groups of cooperative Game Theory solutions. Of these, we can stress the importance of Nash's axiomatic solution, which used axiom sets to assure that the solution is always placed on the Pareto-line. And the Kálmán - Smorodinsky solution can give the last possible point which is the achievable minimum or the solution of the conflict by defining the worst outcome point of the conflict (Molnár – Szidarovszky, 1994).

Conflict alleviation methods will be demonstrated with a two-person case. In our example, let S_1 and S_2 be the players' strategy sets, and φ_1 and φ_2 the two payoff functions. The set of possible payoffs can therefore be as follows:

$$H = \{\varphi_1(x, y), \varphi_2(x, y) \mid (x, y) \in S_1 \times S_2\}$$

In this case, as always, both players aim at maximizing their payoffs, but their respective payoffs are naturally dependent on the other player's strategy, and a general rule is that raising one player's payoff leads to a drop in the other's (Nowak – May, 1992). Therefore, our task is that we have to find a solution that is acceptable to both parties. Before each solution, we have to state that if there's no cooperation, both parties will get either a lower payoff, or a penalty.

General definitions:

$$f_* = (f_{1*}, f_{2*})$$

this will be our payoff vector, for which we assume that there is a $(f_1, f_2) \in H$, for which $f_1 > f_{1*}$ and $f_2 > f_{2*}$. The conflict is defined mathematically by the (H, f_*) pair. This pair was defined in Figure 2. We will also assume that set H is closed, convex and bounded, which therefore means that:

$$(f_1, f_2) \in H \text{ and } \bar{f}_1 \leq f_1, \bar{f}_2 \leq f_2$$

for which $(\bar{f}_1, \bar{f}_2) \in H$ essential, and bounded in both coordinates, therefore

$$\sup \{f_i \mid (f_1, f_2) \in H\} < \infty$$

in case of $i = 1, 2$.

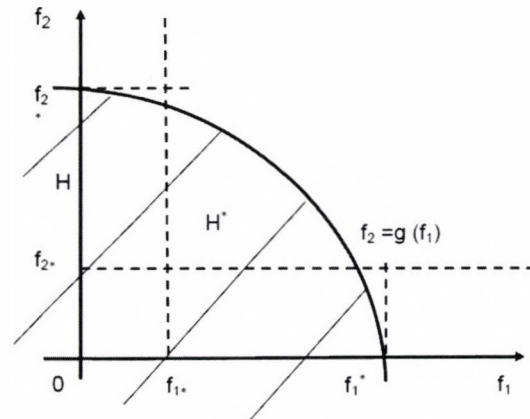

Figure 2: Graph of conflict
Source: based on Molnár-Szidarovszky, 2011c

Furthermore, we also assume that H 's borderline is the graph of function $f_2 = g(f_1)$, which is strictly decreasing in point f_1 and concave. The graph of function g is usually called the Pareto line, therefore the optimum criteria for sustainability can only be satisfied here. Between the game and solution dependencies, we have to take note that no rational player will accept a partnership which means a worse payoff than a payoff without any partnerships.

Therefore, the possible payoff set can be narrowed as such:

$$H^* = \{f_1, f_2 \mid f_1 \geq f_{1*}, f_2 \geq f_{2*}, (f_1, f_2) \in H\}$$

Model of oligopolistic games

Oligopolistic game solutions are the most popular for the modeling of economic decision processes. They can be used for both cooperative and non-cooperative strategies; however, in my dissertation, I wish to present the cooperative model to define the sustainable maximization of the usefulness function, due to the importance of the sustainability attribute system.

There may be two relevant problems of economic science in the case of the usefulness function. The first problem was that the consumers aren't only defined by one usefulness function, but by an unlimited number of functions, and they are equivalent to each other. The second came up when the choice was made during insecurity. The solutions used on oligopolistic games can maximize the players' usefulness functions with the highest probability when the criteria are fixed and the strategies used are cooperative (Simonovits, 2003; Ichiishi, 1983).

In the wide scale of engineering (environmental protection) tasks, we can meet with exact problems that have a mathematical model which may be reduced to an oligopolistic game. Multi-player Game Theory may be used to examine many variations of problems (Szilágyi, 2005). In the following example, I'll try to introduce the process of optimum search based on oligopolistic games by concentrating on a single product in the market process (this could be, e.g. green energy on the energy market), and by including market players and groups (manufacturers, transporters, regulators, implementers, etc.), who have an impact on the changes of the product's cost, and the creation of the point of equilibrium.

In case of cooperative games, giving up on independence must result in the raise in profits for players (Simonovits, 2003).

General definitions for cooperative games:

φ_k – payoff function

S_k – strategic sets (x_1^*, \dots, x_n^*) – strategic attributes

n – a certain positive integer

k – a certain set of S_k

Condition: for $=1,2,3,\dots,n$, $x_k^* \in S_k$, and for every given $x_k \in S_k$

$$\varphi_k(x_1^*, \dots, x_n^*) \geq \varphi_k(x_1^*, \dots, x_k^*, \dots, x_n^*).$$

The inequality could be defined in words as such: for the k -th player ($1 \leq k \leq N$), the equilibrium strategy is the optimal strategy, assuming the other players choose the correct equilibrium strategy. The cooperative game results in a coalition where the coalition itself can always generate profits unlike those who are not members.

Maximum of cooperative game, profits of coalition:

Let's assume that a set M of players k makes the

$$M = \{i_1, i_2, \dots, i_k\}$$

coalition. Furthermore, let us take the game defined by

$$X = x_{j=1}^k S_{ij} \text{ and } Y = x_{l \neq i_j} S_l$$

strategy sets, and

$$\tilde{\varphi}_1(x) = \sum_{j=1}^k \varphi_{i_j}(x), \quad \tilde{\varphi}_2(x) = -\tilde{\varphi}_1(x)$$

payoff functions. It is obvious that function $\tilde{\varphi}_1$'s „max-min“ value, meaning

$$v(M) = \max_{x_{i_j}} \min_{x_{l \neq i_j}} \tilde{\varphi}_1(x) \text{ and } v(\emptyset) = 0$$

quantity – in which it exists – is only dependent on set M . The coalition assumes that players not in the coalition aim at minimizing the coalition's profits.

Example for oligopolistic problem handling:

To keep it simple, let's assume that $M=1, i_1=\dots=i_n=1$, meaning we only examine a single product, and every group consists of a single unit. Referring to the known max-min function, f can be differentiated into the $[0, \xi]$ interval. Let $I=\{i_1, \dots, i_r\} \subset \{1, \dots, N\}$ be a coalition (Molnár – Szidarovszky, 1994).

In this case, $v(I)$ can be as follows:

$$v(I) = \max_{x_i} \min_{x_j} \sum_{i \in I} \varphi_i(x), \text{ where } \max \rightarrow i \in I \text{ and } \min \rightarrow j \notin I.$$

To calculate value $v(I)$, first we need to calculate the

$$\min_{x_j} \varphi_i(x) = \psi_I(x_{i_1}, \dots, x_{i_r}) \text{ where } j \notin I$$

quantity.

We differentiate two possible cases during problem solution:

1) is if $\sum_{j \in I} L_j \geq \xi$, then obviously

$$\psi_1(x_{i_1}, \dots, x_{i_r}) = - \sum_{i \in I} K_i(x_i)$$

2) is if $\sum_{j \in I} L_j < \xi$, then obviously

$$\psi_1(x_{i_1}, \dots, x_{i_r}) = \left(\sum_{i \in I} x_i \right) f \left(\sum_{j \in I} L_j + \sum_{i \in I} x_i \right) - \sum_{i \in I} K_i(x_i)$$

In our first case, function ψ_1 's maximum point is based on functions' K_i 's increase, meaning $x_{i_1}=\dots=x_{i_r}=0$, therefore,

$$v(I) = - \sum_{i \in I} K_i(0)$$

Let's introduce the $L_I = \sum_{i \in I} L_i$ and $L_{\bar{I}} = \sum_{j \notin I} L_j$ definitions for our second case.

Then, according to the formula above:

$$\psi_1(x_{i_1}, \dots, x_{i_r}) = s_I f(L_I + s_I) - \sum_{i \in I} K_i(x_i) \text{ where } s_I = \sum_{i \in I} x_i$$

We can solve the above written equality with a programming task. We can use dynamic programming for the numeric solution (Molnár – Szidarovszky, 1994; Simonovits, 2003).

Method of equal compromise

The search for the solutions to environmental problems can be solved in different ways, as I've already mentioned at the beginning of the chapter; therefore, the optimum point, conclusion point or solution can manifest on the Pareto line in multiple coordinates. The method we use is dependent on the attitude of the one who does the optimization, his beliefs, intuition, and the nature of the processed problem (Axelrod, 1984).

Out of all the employable conflict alleviation methods, I chose the method of equal compromise to demonstrate the Game Theory solution, which (in case of two players) assumes that both players reduce their requirements at the exact same pace, to the point where they arrive at a possible solution. One of the method's characteristics is that there is usually a single solution point, and giving it outlines the optimal criteria system for the players (Forgó et al., 2005). This means that they accept the first solution (which is probably the best possible for both of them) as the solution to the conflict, or conclusion point. If both players want the maximum payoff, the (f_1^*, f_2^*) point is needed, which is not possible.

In case of continuously and collectively decreased requirements, the problem's definition (if the solution is (f_1, f_2)), the two players always give $f_1^* - f_1$ and $f_2^* - f_2$ discounts, therefore, in case of equal discounts:

$$f_1^* - f_1 = f_2^* - f_2 = g(f_1)$$

Transforming the equation to f_1 :

$$f_1 - g(f_1) + (f_2^* - f_1^*) = 0$$

where we see the left side strictly increasing, for $f_1=f_1^*$, $f_1^* - f_2^* + (f_2^* - f_1^*) < 0$ and for $f_1=f_1^*$, $f_1^* - f_2^* + (f_2^* - f_1^*) > 0$, therefore, there is exactly one solution for the problem (Molnár – Szidarovszky, 1995).

4. Conclusions and summary

My hypothesis is that the previously introduced non-cooperative and cooperative Game Theory solutions are applicable to mathematically defining sustainability criteria, since they allow the determination of points of equilibrium for economic, production, and strategic creation and planning processes, which create a clear basis for both long-term sustainable resource usage, and avoidance of economy development processes which have a detrimental effect. During the control and implementation of the Game Theory method, we refer to the „Layer by layer method,“ meaning row after row solution of Rubik's Cube, which has the characteristic of being applicable to modeling the process of project development and the attributes that have an impact on each other during the development, through the logical sequence.

According to the hypothesis on the solution algorithms of the Rubik's Cube, the parts rotated next to each other, meaning the project attributes which have an impact on each other, have a relation system which can be defined in mathematical terms, therefore, their point of balance (e.g. Nash's) can also be determined by Game Theory models (games of finite kind, zero sum games, oligopolistic games, etc.).

My analyses on Game Theory strategy models show that in today's practice, we can find a multitude of economic strategy models that don't really work as intended. The reason for this is basically the over-complication of the models and the inclusion of the multitude of factors and criteria. In order to save the process of modeling and the actual mechanisms of the models from falling into the category of „too complicated, no thanks,” we require a simplified and yet correctly working model that is easy to interpret, can be properly loaded with different data, and easy to correct. During the analysis of the Game Theory models and the strategic optimum search systems, I came to the conclusion that it is more beneficial to use smaller, individual and unique Game Theory solutions which have different reactions in a business environment to describe the process of equilibrium search instead of using complex multi-factor model-structures to describe the entire process in the form of functions. In case of development processes for renewable energy production, in other words, advancement from fossilized to renewable energy sources, by dividing the development program to three levels, then using non-cooperative Game Theory method for the first, constant or zero sum game for the second, and finally, to define output criteria, cooperative Nash-equilibrium search with multi-player oligopolistic game for the third, offers a more beneficial result.

The unorthodox Game Theory method I described suggests – during the phase of actual use – that we use function characteristics which are flexible time-wise for the various levels (input and output), therefore, it may prove applicable to model more complicated processes, if we form an optimum search process by a consecutive use of many simple Game Theory models. These methods/games can also be changed, and flexibly adapted to different economic criteria systems, according to the changes in business environment.

References

- [1] **Axelrod, R.** (1984) *The Evolution of Cooperation*. New York, Basic Books, 1984. pp. 3-8. <http://www-ee.stanford.edu/~hellman/Breakthrough/book/pdfs/axelrod.pdf>
- [2] **Forgó, F. – Pintér, M. – Simonovics, A. – Solymosi, T.** (2005) *Játékelmélet*. Elektronikus jegyzet, BME Budapest, OTKA T046196 2005 pp. 17
- [3] **Forgó, F. – Szép, J. – Szidarovszky, F.** (1999) *Introduction to the Theory of Games*. Kluwer Academic Publisher, Dordrecht, 1999 pp. 22
- [4] **Hardin, G.**: The tragedy of the Commons. *Science* 162, 1968 pp. 1241–1248.
- [5] **Harsányi, J.** (1995) A racionális viselkedés alapjai. *Magyar Szociológiai Társaság, Tanulmányok*, 1995/ 4. szám, Budapest 1995 pp. 1-5.
- [6] **Harsányi, J.** (1995) A racionális viselkedés alapjai. *Magyar Szociológiai Társaság, Tanulmányok*, 1995/ 4. szám, Budapest 1995 pp. 24-25.
- [7] **Hobson, E.** (2012) Can Game Theory be Applied to Family Law Negotiations?: Round Two. *Family Law Dispute Resolution*, 2012 pp. 3-7
<http://www.riverdalemediation.com/wp-content/uploads/2009/07/Hobson-Can-game-theory-be-applied-to-family-law-negotiations-round-two.pdf>
- [8] **Ichiishi, T.** (1983) *Game theory for economic analysis*; Academic press, New York 1983 pp. 10
- [9] **Mező, I.** (2011a) *Játékelmélet*. Unideb.hu, Debreceni Egyetem, Debrecen, 2011, pp. 6-8
- [10] **Mező, I.** (2011b) *Játékelmélet*. Unideb.hu, Debreceni Egyetem, Debrecen, 2011, pp. 9
- [11] **Mészáros, J.** (2005) *Játékelmélet*, Gondolat Könyvkiadó Kft., Budapest, 2005 pp.12-15
- [12] **Molnár, S. – Szidarovszky, F. – Molnár, M.** (2010a) *Játékelmélet és döntési módszerek*. Szent István Egyetem. Egyetemi jegyzet, Gödöllő, 2010 pp. 25-27
- [13] **Molnár, S. – Szidarovszky, F. – Molnár, M.** (2010b) *Játékelmélet és döntési módszerek*. Szent István Egyetem. Egyetemi jegyzet, Gödöllő, 2010 pp. 30-33
- [14] **Molnár, S.** (1994) On the optimization of INPUT-OUTPUT systems cost functions, *Pure Mathematics and Applications*, Vol. 5. No. 4, 1994, pp. 404
- [15] **Molnár, S. – Szidarovszky, F.** (1994) A diszkrét idejű oligopólium játékok stabilitásáról, *SZIGMA*, Vol. 25. No. 3, Budapest, 1994 pp. 103-105
- [16] **Molnár, S. – Szidarovszky, F.** (1995) A folytonos idejű termelői-fogyasztói modellek stabilitásáról, *SZIGMA*, Vol. 26. No. 3-4., Budapest, 1995 pp. 95
- [17] **Molnár, S. – Szidarovszky, F.** (2011a) *Játékelmélet. Többcélú optimalizáció, konfliktuskezelés, differenciáljátékok*. ComputerBooks, Budapest, 2011 pp. 16-17
- [18] **Molnár, S. – Szidarovszky, F.** (2011b) *Játékelmélet. Többcélú optimalizáció, konfliktuskezelés, differenciáljátékok*. ComputerBooks, Budapest, 2011 pp. 18-19
- [19] **Molnár, S. – Szidarovszky, F.** (2011c) *Játékelmélet. Többcélú optimalizáció, konfliktuskezelés, differenciáljátékok*. ComputerBooks, Budapest, 2011 pp. 46-47
- [20] **Molnár, S. – Kelecsényi, S.** (2009) *Hungarian National Climate Change Strategy Mitigation, adaptation and a low carbon economy*. CIRCLE-APM, 2009. pp. 22.
- [21] **Nagy, G.** (2008a,b,c) *Megoldáskereső Módszerek*. Informatikai szakdolgozat. Debreceni Egyetem Informatikai Kar, Debrecen, 2008, pp. 12-16, pp. 22-25, pp. 40-45
- [22] **Neumann, J. – Morgenstern, O.** (2007) *Theory of Games and Economic behavior*. Sixtieth-Anniversary Edition. Princeton University Press, New Jersey, 2007 pp. 13.
- [23] **Nowak, M. – May, R.** (1992) Evolutionary games and spatial chaos. *Nature* 359, 1992 pp. 826–827.
- [24] **Simonovits, A.** (2003) Neumann János és a játékelmélet *Természet Világa*, 2003. III. különszám, Neumann-émlékszám Különszámaink /Neumann emlékszám, pp. 1. (<http://www.termeszetvilaga.hu>)
- [25] **Solymosi, T.** (2009) Kooperatív játékok. *Magyar Tudomány. A Magyar Tudományos Akadémia Lapja*. 2009/05 pp. 547 <http://www.matud.iif.hu/2009/09maj/05.htm>
- [26] **Szidarovszky, F.** (1978a) Nash-féle kooperatív megoldási koncepció általánosításáról. *Sigma*, Budapest, 1978 pp. 70
- [27] **Szidarovszky, F.** (1978b) *Játékelmélet*. ELTE TTK jegyzet, Budapest, 1978 pp. 7-9.
- [28] **Szidarovszky, F. – Molnár, S.** (1986) *Játékelmélet műszaki alkalmazásokkal*. Műszaki Könyvkiadó, Budapest 1986 pp. 220-225
- [29] **Szidarovszky, F. – Molnár, S. – Molnár, M. – Fogarassy, Cs.** (2013) Modeling Conflicting Interests in Water Distribution Problem with Game Theory. *University of Arizona*. (2013) pp. 162-165
- [30] **Szilágyi, M.** (2005): Találkozás a játékelmélettel, *Beszélő folyóirat*, 2005. június–július, Évfolyam 10, Szám 6 pp. 1
- [31] **Vincze, J.** (2009) A játékelmélet és gazdasági intézmények. *Magyar Tudomány. A Magyar Tudományos Akadémia Lapja*. 2009/05 pp. 568 <http://www.matud.iif.hu/2009/09maj/07.htm>

CONTENTS OF NO 26/2014

EXTERNALITY ANALYSIS OF SUSTAINABLE CATTLE BREEDING SYSTEMS

Cs. Fogarassy – M. Bakosné Böröcz
Szent István University, Faculty of Economics and Social Sciences,
Institute of Regional Economics and Rural Development., 1. Páter Károly street,
Gödöllő, 2100, Hungary5

POSSIBILITY OF DENDROMASS PRODUCTION ON WOODY ENERGY PLANTATIONS

A. Vágvölgyi – M. Dancs – I. Czupy
University of West – Hungary, Faculty of Forestry,
Institute of Forest- and Environmental Techniques,
H-9400 Sopron, Ady E. st. 5.,11

APPLICATION OF NUMERICAL ANALYSIS FOR THE DESIGN OF ROTATING TOOLS

T. Major¹ – V.Csanády²
¹University of West –Hungary, Faculty of Forestry,
Institute of Forest- and Environmental Techniques
H-9400 Sopron, Ady E. st. 5.,
²University of West –Hungary, Faculty of Forestry,
Institute of Mathematics, H-9400 Sopron, Ady E. st. 5., 16

EXAMINING THE VELOCITY- AND TIME-DEPENDENT FRICTION IN CASE OF STEEL AND POLYAMIDE

A. Csatar¹ – F. Safranyik²
¹Scientific Deputy General Director, Hungarian
Institute of Agricultural Engineering
²Szent István University, Faculty of Mechanical
Engineering, Department of Mechanics and
Technical Drawing20

LOOKING BEHIND THE PROCESS OF PYROLYSIS IN WASTE MANAGEMENT: QUESTIONS ON THE COMPOSITION AND QUALITY OF END-PRODUCT AND THEIR ANSWERS BY MEAS OF ANALYTICAL CHEMISTRY

K. Lányi¹, E. Molnár¹, I. Vanó¹ and P. Korzenszky²
¹Faculty of Economics, Agricultural and Healthcare
Studies, Szent István University
Szabadság út 1-3., Szarvas, H-5540,
Hungary, Tel.:+36 66 561630
²Faculty of Mechanical Engineering, Szent István
University, Páter K. út. 1,
Gödöllő, H-2100, Hungary25

APPLE CLASSIFICATION WITH SHAPE DESCRIPTION USING 3D IMAGING TECHNOLOGIES

A. Lágymányosi, I. Szabó
Faculty of Mechanical Engineering, Szent István
University, Páter K. u. 1., Gödöllő, H-2103, Hungary29

WATER MANAGEMENT IN MIDDLE EAST AND NORTH AFRICA

J. S. Zsarnóczai, Bahaa Asma, A. Vajda
Szent István University, Faculty of Economic and Social Sciences,
Institute of Regional Economics and Rural Development,
2103 Gödöllő, Páter Károly utca 1., Hungary.....32

TECHNOLOGICAL FEATURES OF BIOGAS PLANTS USING MIXED MATERIALS

L. Tóth, J.Beke, Z. Bártfai, I. Szabó, G. Hartdégén, I. Oldal, Z. Blahunka
Szent István University,
Hungary, Gödöllő, 2100 Páter K. u. 1.39

COMPARISON OF POSSIBLE GREENHOUSE ENERGY SOURCES

J. Nagygál¹, L. Tóth¹, J.Beke¹, I. Szabó²
Szent István University, Hungary,
2100 Gödöllő, Páter K. u. 1.
¹Institute of Process Engineering,
²Institute of Mechanics and Machinery.....47

THEORY OF COOPERATIVE AND NON-COOPERATIVE GAMES IN PRACTICE OF ENVIRONMENTAL OR SUSTAINABLE PROCESS MODELING

Cs. Fogarassy
Szent István University, Faculty of Economics and Social Sciences,
Institute of Regional Economics and Rural Development.,
1. Páter Károly street, Gödöllő, 2100, Hungary54

PROBABILITY AND STATISTICS

Chapter 1: Introduction to Probability

Chapter 2: Descriptive Statistics

Chapter 3: Inferential Statistics

Chapter 4: Regression Analysis

Chapter 5: Hypothesis Testing

Chapter 6: Bayesian Statistics

Chapter 7: Stochastic Processes

Chapter 8: Queueing Theory

Chapter 9: Simulation

Chapter 10: Reliability Engineering

Chapter 11: Risk Analysis

Chapter 12: Quality Control

Chapter 13: Forecasting

